

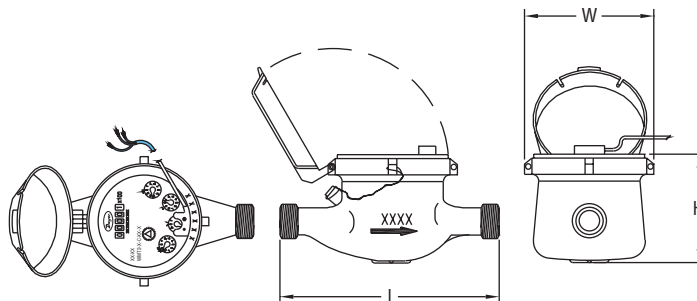

Series WMT2 Multi-Jet Water Meters with Pulsed Output

Specifications - Installation and Operating Instructions



Size in (mm)	Spud NPSM (BSPP)	Length 'L' in (mm)	Width 'W' in (mm)	Height 'H' in (mm)	Weight lb (kg)
5/8 (15)	3/4" (3/4")	6-1/2 (165)	3-45/64 (94)	4-15/64 (107.5)	3.75 (1.7)
5/8 x 3/4	1" (1")	7-1/2 (190)	3-45/64 (94)	4-15/64 (107.5)	3.97 (1.8)
3/4 (20)	1" (1")	7-1/2 (190)	3-45/64 (94)	4-15/64 (107.5)	4.9 (2.2)
1 (25)	1-1/4" (1-1/4")	10-1/4 (260)	3-55/64 (98)	4-5/8 (117.5)	6.4 (2.9)
1-1/4 (32)	1-1/2" (1-1/2")	10-1/4 (260)	3-55/64 (98)	4-5/8 (117.5)	8.2 (3.7)
1-1/2 (40)	2" (2")	11-13/16 (300)	4-51/64 (122)	5-9/16 (141.5)	13.52 (6.17)
2 (50)	2-1/2" (2-1/2")	11-13/16 (300)	5-45/64 (145)	6-31/32 (177)	18.74 (8.5)

The Series WMT2 Multi-Jet Water Meter is ideal for commercial and industrial applications. The multi-jet design allows simplicity and accuracy with wide flow ranges, even in low flow applications. The magnetically driven, hermetically sealed register will not leak or fog and is completely separated from the water. These water meters are designed for long service life and maintenance-free operation.

Installation Instructions

1. Thoroughly flush the service line upstream of the meter to remove dirt and debris.
2. Remove meter spud thread protectors.

Note: To protect meter spud threads, store the meter with thread protectors in place.

3. Set the meter in the line. Install in a horizontal plane, with the register upright, in a location accessible for reading, service and inspection. Arrows on the side of the meter and above the outlet spud indicate the direction of flow.
4. For accurate measurement, the tap height should be higher than the meter.
5. Do not over-tighten connections; tighten only as required to seal. Do not use pipe sealant tape on meter threads.
6. With upstream shut-off valve only: Open shut-off valve slowly to remove air from meter and service line. Open a faucet slowly to allow entrapped air to escape. Close the faucet.

With both upstream and downstream shut-off valves installed:

7. Test the installation for leaks: Close the outlet (downstream) shutoff valve. Open the inlet (upstream) shut-off slowly until meter is full of water. Open the outlet (downstream) valve slowly until air is out of the meter and service line. Open a faucet slowly to allow entrapped air to escape. Close the faucet.

SPECIFICATION

- Service:** Water.
- Wetted Materials:** Body: Brass, polyethylene; Couplings: Brass; Measuring Chamber: Polyethylene, ABS plastic, ferrite, acetel.
- Flow Range:** See model chart.
- Accuracy:** Transitional Flow: ±5%; Nominal Flow: ±2%.
- Temperature Limit:** 104°F (40°C).
- Pressure Limit:** 232 psi (16 bar).
- Pressure Drop:** See pressure drop chart.
- Totalizing Display Maximum:** See model chart.
- Output Signal:** Pulse output with frequency proportional to flow rate.
- Pulse Options:** 0.1 gal, 1 gal, 10 gal, 100 gal per pulse (1 L, 10 L, 100 L per pulse).
- Electrical Rating:** 0.01 A @ 24 VAC/DC.
- Electrical Connections:** Color-coded lead wires, 4.5' (1.5 m) long.
- Mounting Orientation:** Horizontal with register face up.
- Weight:** See dimension chart.

CAUTION Unit must be installed in a horizontal position with the register face pointing up otherwise leakage and/or meter damage will occur.

Model	Coupling Size	Size	Max Flow	Nominal Flow Range	Transitional Flow	Display Max (Gallons)	Pulse Rate (Gal./Pulse)
			GPM (Gallons Per Minute)				
WMT2-A-C-01	1/2" NPT	5/8 x 1/2"	20	1 to 10	0.25	9,999,999.99	0.1
WMT2-A-C-02	3/4" NPT	5/8" x 3/4"	20	1 to 20	0.25	9,999,999.99	0.1
WMT2-A-C-03	3/4" NPT	3/4"	30	2 to 30	0.25	9,999,999.99	0.1
WMT2-A-C-04	1" NPT	1"	50	3 to 50	0.75	9,999,999.99	0.1
WMT2-A-C-01-1	1/2" NPT	5/8 x 1/2"	20	1 to 10	0.25	9,999,999.99	1
WMT2-A-C-02-1	3/4" NPT	5/8" x 3/4"	20	1 to 20	0.25	9,999,999.99	1
WMT2-A-C-03-1	3/4" NPT	3/4"	30	2 to 30	0.25	9,999,999.99	1
WMT2-A-C-04-1	1" NPT	1"	50	3 to 50	0.75	9,999,999.99	1
WMT2-A-C-06-10	1-1/2" NPT	1-1/2"	100	5 to 100	1.5	99,999,999.9	10
WMT2-A-C-07-10	2" NPT	2"	160	80 to 160	2	99,999,999.9	10
WMT2-A-C-04-100	1" NPT	1"	50	3 to 50	0.75	9,999,999.99	100
WMT2-A-C-07-100	2" NPT	2"	160	80 to 160	2	99,999,999.9	100

Model	Coupling Size	Size	Max Flow	Nominal Flow Range	Transitional Flow	Display Max (m ³)	Pulse Rate (L/Pulse)
WMT2-B-C-08-1	1/2" BSPT	15 mm	3	0.12 to 1.5	0.03	99,999.9999	1
WMT2-B-C-10-1	3/4" BSPT	20 mm	5	0.2 to 2.5	0.05	99,999.9999	1
WMT2-B-C-11-1	1" BSPT	25 mm	7	0.25 to 3.5	0.07	99,999.9999	1
WMT2-B-C-12-1	1-1/4" BSPT	32 mm	12	0.48 to 6	0.12	99,999.9999	1
WMT2-B-C-08-10	1/2" BSPT	15 mm	3	0.12 to 1.5	0.03	99,999.9999	10
WMT2-B-C-12-10	1-1/4" BSPT	32 mm	12	0.48 to 6	0.12	99,999.9999	10
WMT2-B-C-14-10	2" BSPT	50 mm	30	1.2 to 15	0.3	999,999.9999	10
WMT2-B-C-12-100	1-1/4" BSPT	32 mm	12	0.48 to 6	0.12	99,999.9999	100
WMT2-B-C-14-100	2" BSPT	50 mm	30	1.2 to 15	0.3	999,999.9999	100

Meter Reading

The total flow that has passed through your meter is read by starting at the top of the register with the Five-Digit Totalizer, and then read clockwise around the small dials. In the example below, the Five-Digit Totalizer reads 13800 (138 x 100), and the dials read 60 (6 x 10), 2 (2 x 1), and 0.4 (4 x 0.1) respectively. The total flow is 13862.4.

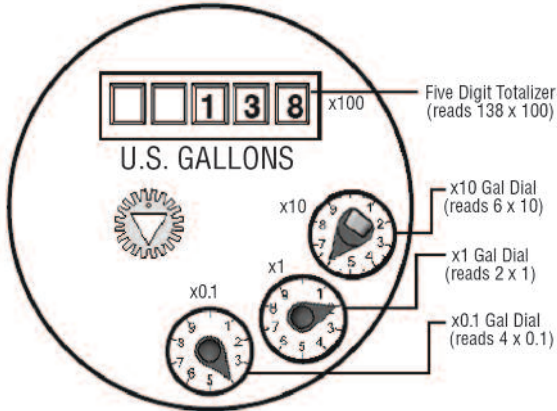

INSTALLATION

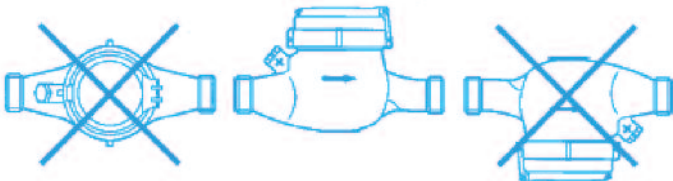

ELECTRICAL INSTALLATION

Dry contact closure, does not require power.

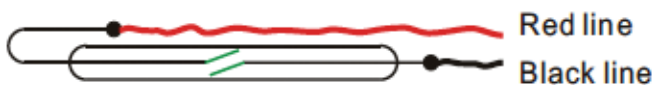

Pressure Drop

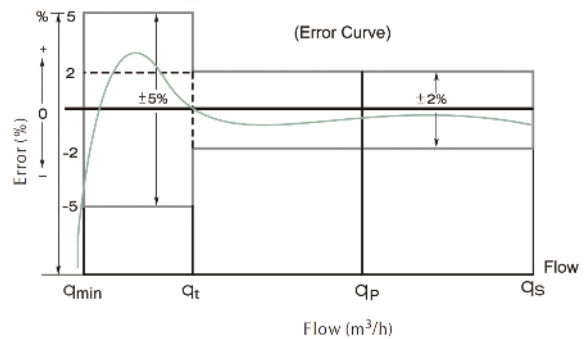
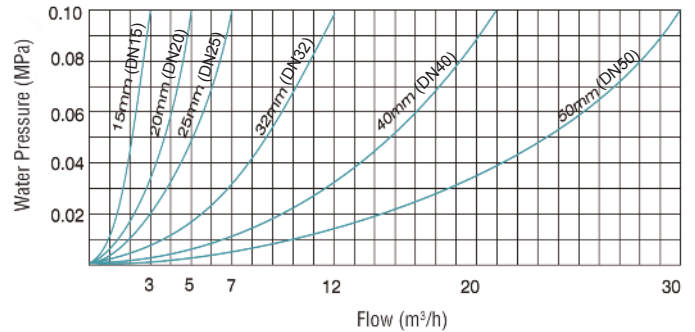
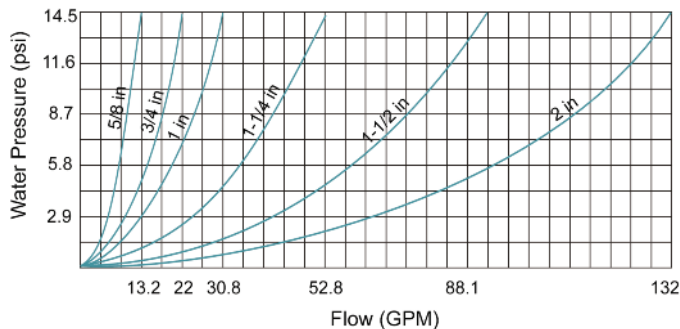

Accuracy Chart

MAINTENANCE/REPAIR

Preventative maintenance consists of periodic inspections and cleaning procedures. The procedures should be performed at regular intervals, and any defects discovered should be corrected before further operation of the meter.

Visually inspect the meter for missing hardware, broken resistor glass, or other signs of wear or deterioration. Verify proper flow rate and pressure for meter. A loss in pressure, with the resulting flow rate decrease, may indicate the meter screen is clogged and requires cleaning.

Clean the strainer yearly, or as required, depending on water condition. Pull out the strainer or back flush the meter to loosen trapped particulates.

The Series WMT2 is not field serviceable and should be returned if repair is needed. Field repair should not be attempted and may void warranty.

WARRANTY/RETURN

Refer to "Terms and Conditions of Sales" in our catalog and on our website. Contact customer service to receive a Return Goods Authorization number before shipping the product back for repair. Be sure to include a brief description of the problem plus any additional application notes.