

ENVIRONMENTAL EXPRESS
oakton

Instruction Manual

pH/ORP/DISSOLVED OXYGEN METER

PD250

PD260

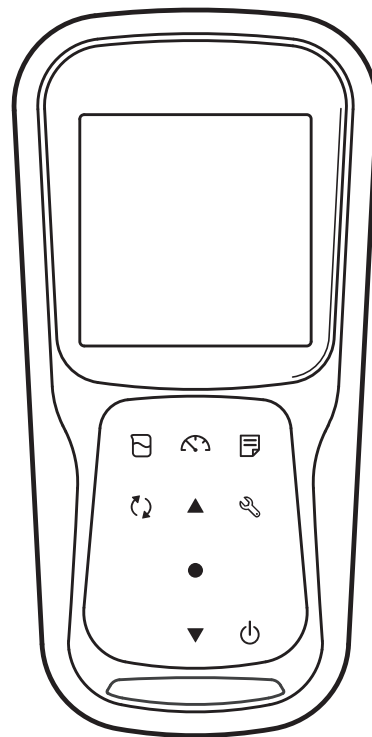

Preface

This manual describes the operation of the following instrument.

Brand: OAKTON
Series name: OAKTON 200 Series Handheld Water Quality Meter
Model: PD250, PD260
Model description: pH/ORP/Dissolved Oxygen Meter

Be sure to read this manual before using the product to ensure proper and safe operation of the product. Also, safely store the manual so it is readily available whenever necessary. Product specifications and appearance, as well as the contents of this manual are subject to change without notice.

Warranty and responsibility

Oakton Instruments warrants that the product shall be free from defects in material and workmanship and agrees to repair or replace free of charge, at option of Oakton Instruments, any malfunctioned or damaged product attributable to responsibility of Oakton Instruments. for a period of Three (3) years from the delivery unless otherwise agreed in a written statement. In any one of the following cases, none of the warranties set forth herein shall be extended:

- Any malfunction or damage attributable to improper operation
- Any malfunction attributable to repair or modification by any person not authorized by Oakton Instruments.
- Any malfunction or damage attributable to the use in an environment not specified in this manual
- Any malfunction or damage attributable to violation of the instructions in this manual or operations in the manner not specified in this manual
- Any malfunction or damage attributable to any cause or causes beyond the reasonable control of Oakton Instruments. such as natural disasters
- Any deterioration in appearance attributable to corrosion, rust, and so on
- Replacement of consumables

OAKTON INSTRUMENTS. SHALL NOT BE LIABLE FOR ANY DAMAGES RESULTING FROM ANY MALFUNCTIONS OF THE PRODUCT, ANY ERASURE OF DATA, OR ANY OTHER USES OF THE PRODUCT.

Trademarks

Microsoft, Windows, Windows Vista are registered trademarks or trademarks of Microsoft Corporation in the United States and other countries.

Other company names and brand names are either registered trademarks or trademarks of the respective companies. (R), (TM) symbols may be omitted in this manual.

CODE:M003812-3200828209-GZ0000581083
November,2019 © 2019 Oakton Instruments.

Regulations

Regulations

EU regulations

Conformable standards

This equipment conforms to the following standards:



EMC: EN61326-1
Class B, Basic electromagnetic environment
RoHS: EN50581
9. Monitoring and control instruments

Warning: This product is not intended for use in industrial environments. In an industrial environment, electromagnetic environmental effects may cause the incorrect performance of the product in which case the user may be required to take adequate measures.

Information on disposal of electrical and electronic equipment and disposal of batteries and accumulators

The crossed out wheeled bin symbol with underbar shown on the product or accompanying documents indicates the product requires appropriate treatment, collection and recycle for waste electrical and electronic equipment (WEEE) under the Directive 2012/19/EU, and/or waste batteries and accumulators under the Directive 2006/66/EC in the European Union. The symbol might be put with one of the chemical symbols below. In this case, it satisfies the requirements of the Directive 2006/66/EC for the object chemical. This product should not be disposed of unsorted household waste. Your correct disposal of WEEE, waste batteries and accumulators will contribute to reducing wasteful consumption of natural resources, and protecting human health and the environment from potential negative effects caused by hazardous substance in products.

Contact your supplier for information on applicable disposal methods.

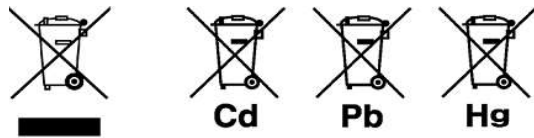

Regulations

Authorised representative in EU

FCC rules

FCC Compliance Statement

This device complies with part 15 of the FCC Rules. Operation is subject to the following two conditions: (1) This device may not cause harmful interference, and (2) this device must accept any interference received, including interference that may cause undesired operation.

Responsible Party for FCC matter

Note

This equipment has been tested and found to comply with the limits for a Class A digital device, pursuant to part 15 of the FCC Rules. These limits are designed to provide reasonable protection against harmful interference when the equipment is operated in a commercial environment. This equipment generates, uses, and can radiate radio frequency energy and, if not installed and used in accordance with the instruction manual, may cause harmful interference to radio communications. Operation of this equipment in a residential area is likely to cause harmful interference in which case the user will be required to correct the interference at his own expense.

Any changes or modifications not expressly approved by the party responsible for compliance could void the user's authority to operate the equipment.

For Your Safety

For Your Safety

Hazard classification and warning symbols

Warning messages are described in the following manner. Read the messages and follow the instructions carefully.

Hazard classification



This indicates an imminently hazardous situation which, if not avoided, will result in death or serious injury. This is to be limited to the most extreme situations.



This indicates a potentially hazardous situation which, if not avoided, could result in death or serious injury.



This indicates a potentially hazardous situation which, if not avoided, may result in minor or moderate injury. It may also be used to alert against unsafe practices.

Warning symbols



Description of what should be done, or what should be followed.



Description of what should never be done, or what is prohibited.

For Your Safety

Safety precautions

This section provides precautions for using the product safely and correctly and to prevent injury and damage. The terms of DANGER, WARNING, and CAUTION indicate the degree of immanency and hazardous situation. Read the precautions carefully as it contains important safety messages.

Instrument and electrode

WARNING



Do not disassemble or modify the instrument. Otherwise, it may heat up or be ignited resulting in a fire or an accident.

CAUTION



Harmful chemicals

Some electrodes are used with hazardous standard solutions. Handle them with care. The internal solution of pH electrode is highly concentrated potassium chloride (3.33 mol/L KCl) and internal solution of DO electrode is highly concentrated potassium hydroxide (KOH). If the internal solution comes in contact with the skin, wash it off immediately. If it gets into the eyes, flush with plenty of water and then consult a doctor.



Broken glass

Broken glass may cause injury. The outer tube and tip of an electrode are made of glass. Handle them with care.



Do not use the phono jack under wet or humid conditions. Otherwise, it may cause a fire, electric shock, or breakage.

For Your Safety

Battery

WARNING



Keep batteries out of reach of children. If someone accidentally swallows a battery, consult a doctor immediately.



If alkaline fluid from a battery gets into the eyes, do not rub the eyes, rinse with clean water immediately and then consult a doctor. Contact with alkaline fluid could cause blindness.



Do not put batteries in a fire, expose to heat, disassemble or remodel. Doing so can cause fluid leakage, overheating or explosion.

Product Handling Information

Product Handling Information

Operational precautions (instrument)

Only use the product including accessories for their intended purpose.

Do not drop or physically impact the instrument.

The instrument is made of solvent-resistant materials but that does not mean it is resistant to all chemicals. Do not expose the instrument in strong acid or alkali solution, or wipe with such solution.

If the instrument is dropped into water or gets wet, wipe it using soft cloth. Do not heat to dry it.

The instrument has a dust-proof and waterproof structure i.e., the instrument does not malfunction even when immersed in water of 1 m depth for 30 minutes. This does guarantee non-destructive, trouble-free, dust-proof, and waterproof performance in all situations.

When replacing the batteries or when a serial cable connected, the instrument does not have the dust-proof and waterproof performance. The dust-proof and waterproof performance is maintained only when the covers are attached correctly.

After replacing the batteries or removing the serial cable connected, make sure that the waterproof gasket attached to the cover is not deformed or discolored, or has foreign matter adhering to it. If the waterproof gasket is deformed, discolored or has foreign matter adhering to it, dust could get inside, water leaks could occur that could lead to instrument malfunction.

To disconnect an electrode or serial cable, hold the connector and pull it off. If you pull at the cable, it may cause breakage.

The phono jack communication between the instrument and a personal computer (referred to as PC in the rest of this document) may fail because of environmental conditions, such as electromagnetic noise.

Do not replace the batteries in a dusty place or with wet hands. Dust or moisture could get inside the instrument, possibly causing instrument malfunction.

Do not use an object with a sharp end to press the keys.

If the power supply is interrupted while measurement data is being saved in the instrument, the data could be corrupted.

A Ni-MH rechargeable battery can be used in this instrument.

Operational precautions (battery)

Do not short circuit a battery.

Position the + and – side of the battery correctly.

When the battery has depleted or the instrument will not be used for a long time, remove the batteries.

Of the specified battery types, make sure to use two batteries of the same type.

Do not use a new battery together with a used battery.

Do not use a fully charged nickel-metal hydride battery together with a partially charged battery.

Do not attempt to charge a non-rechargeable battery.

Product Handling Information

Environmental conditions for use and storage

Temperature: 0 °C to 45 °C

Humidity: under 80% relative humidity and free from condensation

Avoid the following conditions:

Strong vibration

Direct sunlight

Corrosive gas environment

Locations close to an air-conditioner

Direct wind

Transportation

When transporting the instrument, repackage it in the original package box. Otherwise, it may cause instrument damage.

Disposal

Standard solution used for the calibration must be under neutralized before the disposal.

When disposing of the product, follow the related laws and regulations of your country for disposal of the product.

X

Contents

■ Product Overview	1
● Package Content.....	1
● Key Features	2
● Product components.....	3
■ Basic operations	7
● Mode and measurement.....	9
■ Calibration	11
● pH Calibration	11
● ORP/mV Calibration.....	13
● DO Calibration.....	15
● Temperature Calibration	21
■ Data	23
● Data capture and storage.....	23
● Data transfer.....	24
■ Setup	25
● P1 pH setup	25
● P1 DO setup	29
● P2 Data setup	33
● P3 General setup	40
● P4 CLK setup	49
■ Maintenance and storage	54
● Maintenance and storage of the instrument	54

Contents

• Maintenance and storage of electrodes	55
■ Error messages and trouble shooting	57
■ Appendix	62
• Appendix 1	62
• Appendix 2	65
• Appendix 3	70

■ Product Overview

This section describes the package content, key features and product components of OAKTON PD200 series Handheld meters.

● Package Content

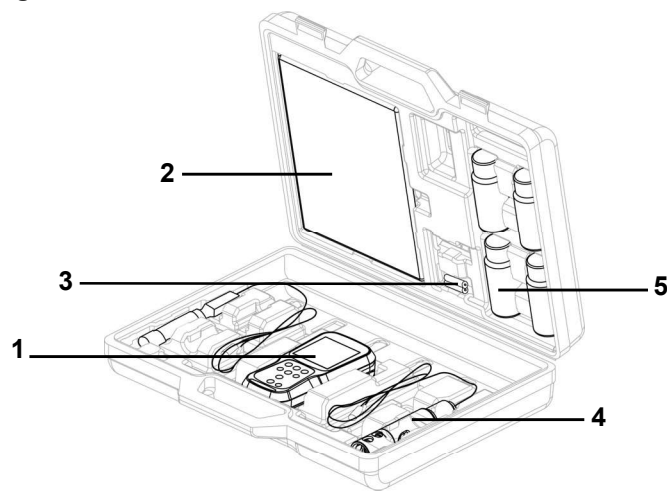

After opening the carry case, remove the meter and check for damage on the instrument and confirm that the standard accessories all exist. If damage or defects are found on the product, contact your dealer.

OAKTON PD200 series Handheld meters and meter kit include the following items:

S.NO.	Name
1	Instrument
2	Instruction manual
3	2 AA batteries
4	Electrodes (Electrodes kit only)
5	Calibrating solutions

Product overview

- **Key Features**

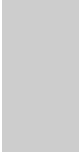

IP67 water ingress, dust-proof, shock-resistant, anti-slip meter housing.
Large monochrome LCD (50 x 50 mm) with white LED back lighting.
Built-in electrode holder (up to 2 electrodes).
Foldable meter stand.
Simple user interface and single parameter display.
500 (for PD250) / 1000 (for PD260) data memory.
Automatic Temperature Compensation (ATC) with temperature calibration.
Adjustable auto shut-off time (1 to 30 minutes).
Auto-hold / Auto stable / Real-time measurement modes with stability indicator.
Powered by 2 x AA batteries.
Real-time clock (only for PD260).
PC (standard USB) / Printer (25 pin serial) connection via 2.5 mm diameter phono jack.

● Product components

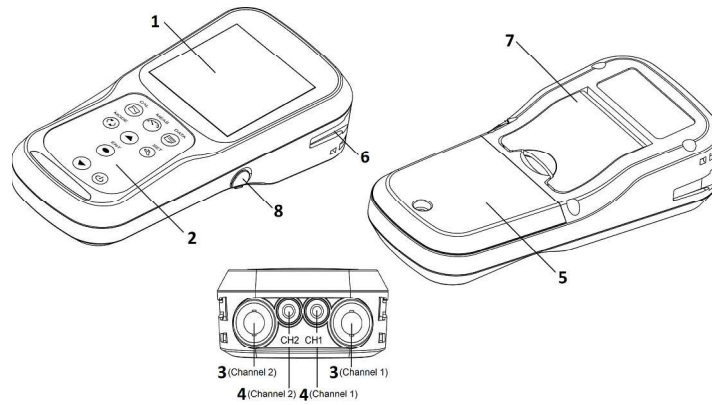





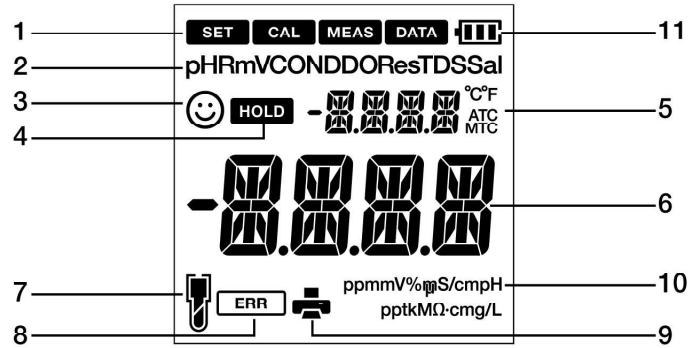

No	Name	Function
1	Monochrome LCD	Displays the measured value
2	Operation keys	Used for instrument operation
3	Electrode connector	Connect to the BNC connector of the electrode
4	Temperature connector (T)	Connect to the temperature sensor of the electrode
5	Battery cover	Open/close to insert/remove batteries
6	Electrode holder	Hold the electrode to carry with the instrument
7	Meter stand	Open stand to place the meter at an inclined position on a flat surface
8	Serial connector	Connects the serial cable and printer cable





Product overview

• Display





No	Name	Function
1	Status Icon	Displays the current operation mode (Setup, Calibration, Measurement and Data mode)
2	Parameters	Displays the measured parameters like pH, RmV, and DO
3		Stability indicator shows value is stable for documentation in Auto Stable and Auto Hold modes
4		Appears when the measured value display is stable and fixed in auto-hold mode
5	Temperature display area	Displays the measured temperature
6	Measured value, set item display area	Displays the measured value and the set value
7		Indicates electrode sensitivity level
8		Indicates error situation
9		Indicates data being transferred to the printer or computer
10	ppmmV%ppS/cm pH pptkMΩ·cmg/L	Displays the unit for the measurement parameter
11		Displays the battery level

● **Battery level display**

	100% battery life
	50% battery life
	20% battery life
	Batteries are weak and need replacement. Refer BATT LOW (page 57) to solve this

● **pH Electrode sensitivity level**

	Electrode sensitivity above 95%(excellent)
	Electrode sensitivity between 85% to 95% (very good)
	Electrode sensitivity between 80% to 85%(good). Refer SLPE ERR (page 57) to solve this

• Keypad operation

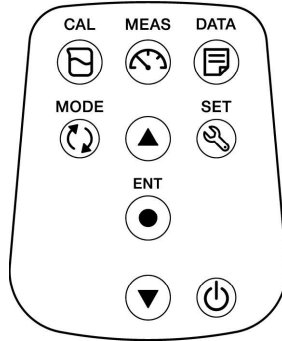

Keypad	Name	Function
	CAL key	Switches from the measurement mode to the calibration mode. Starts calibration in the calibration mode.
	MEAS key	Switches the operation mode to the measurement mode. Releases the fixed measurement value mode in the auto hold mode and begins a fresh measurement.
	DATA key	Switches from the measurement mode to the data mode.
	MODE key	In the measurement mode, changes measurement parameters.
	SET key	Switches from the measurement mode to the setup mode.
	ENTER key	Determines the selection or setup. Saves data in the measurement mode and calibration mode.
	UP key	In the setup mode, navigates between various setups. Selects preferred option in some setup screens.
	DOWN key	Increases or decreases selected digit when entering numbers.
	POWER key	Powers ON/OFF the instrument.

■ Basic operations

This section describes function and basic operation method of each part of OAKTON 200 series Handheld meters.

● Turning on the instrument

Inserting the batteries

This instrument is operated by batteries. You can use AA alkaline batteries or AA Ni- MH chargeable batteries. Perform the following procedure to insert batteries in the instrument.

1. Unscrew the battery cover on the back of the instrument counter-clock wise to unlock the battery cover.
2. Remove the battery cover and set the batteries inside.
3. Replace battery cover.
4. Screw the battery cover on the back of the instrument clockwise to lock the battery cover.

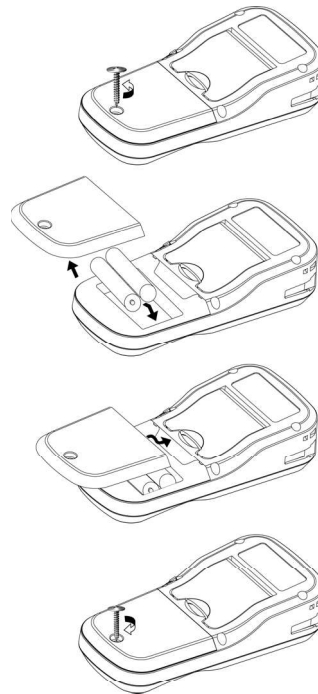

Note

Do not replace the batteries in a dusty place or with wet hands. Dust or moisture could get inside the instrument and possibly cause an instrument malfunction.

Do not short-circuit a battery.

Note polarity as shown in the battery compartment.

When the battery has depleted or the instrument is not used for a long time, remove the batteries.

Of the specified battery types, make sure to use two batteries of the same type.

Do not use a new battery together with an used battery.

Basic operations

• Connecting an electrode

To perform calibration/ measurement, it is necessary to use the appropriate electrode for measurement parameter. Recommended electrodes for various sample are listed in our product catalog. Use the following procedure to correctly connect the electrode to the instrument:

1. Insert the electrode connector by fitting its groove with the connector pin of the instrument (refer below table).
2. Turn the electrode connector clockwise by following the grooves.
3. Slide the connector cover on the connector.
4. When using a combination electrode equipped with a temperature sensor, insert the temperature jack (T) to the ATC socket on the meter.

CH1	CH2
pH Electrode	DO Electrode

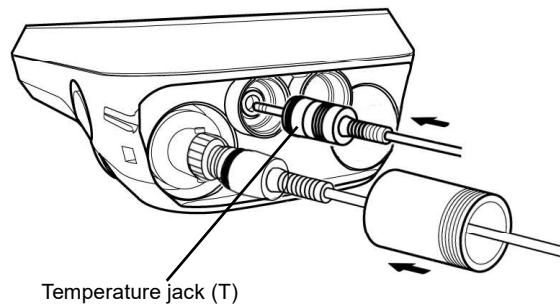
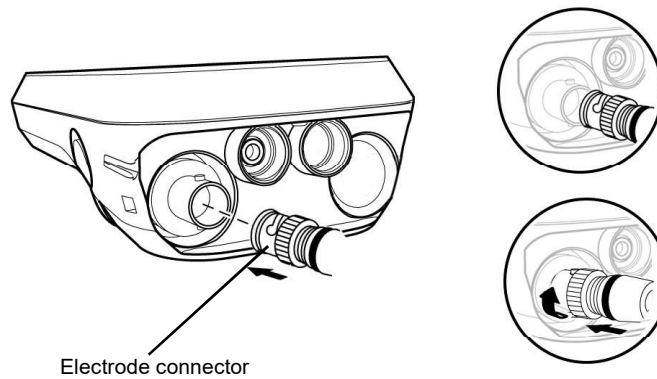

- **Mode and measurement**
- **Changing the operation mode**

You can change the operation mode to four available modes depending on the purpose of use. The status icon indicates the current mode.

Status icons ——— **SET** **CAL** **MEAS** **DATA**

Icon	Name	Function
SET	Setup mode	Perform various setup functions.
CAL	Calibration mode	Performs calibration.
MEAS	Measurement mode	Performs measurement.
DATA	Data mode	Performs data setup. Displays the saved data.

You can change the operation mode using the corresponding key:

Measurement mode: Press the  key to change to the measurement mode.

Calibration mode: In the measurement mode, press the  key to change to the calibration mode.

Data mode: In the measurement mode, press the  key to change to the data mode.

Setup mode: In the measurement mode, press the  key to change to the setup mode.

Basic operations

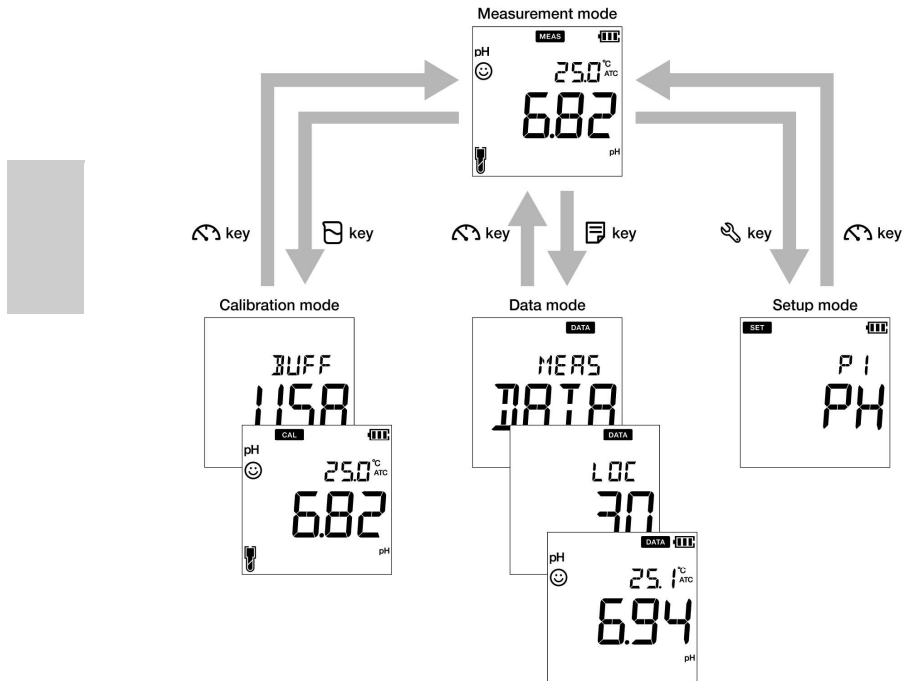

- **Changing the measurement parameter**

This instrument measures multiple parameters. For measurement, an electrode corresponding to the measurement parameter is required. In the measurement mode, the measurement parameter can be changed by pressing the  key.

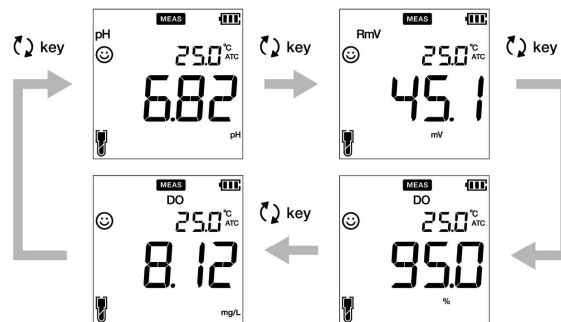

■ Calibration

This section describes the basic calibration method using OAKTON PD200 series Handheld meters, pH electrode and DO electrode.

● pH Calibration

Calibration is necessary for accurate pH measurement. To perform pH calibration, follow the procedure detailed below.

Prerequisites

Clean the pH electrode with DI (deionized) water and wipe it with tissue paper.
Switch on the PD meter and plug in the pH electrode.
Prepare buffer solution required for calibration.
Keep the meter in pH measurement mode.
Dip the pH electrode at least 3 cm in the buffer solution.

Note





Perform two-point calibration using:
pH 7 and 4 for acidic sample.
pH 7 and 10 for alkaline sample.
Perform three-point calibration using pH7, 4 and 10 if you are unsure of the expected sample pH value. It is recommended to calibrate with pH7 first.
Default buffer setup is **BUFF USA**. If you want to change to **BUFF NIST** or **BUFF DIN**, refer to P 1.1 Buffer selection on page 26.

Tip

To abort an ongoing calibration process at any point of time, press the  key.
It is recommended to clear the previous calibration data before performing calibration. For erasing the calibration data, refer to P 1.3 Erase calibration data on page 28.

pH calibration

Calibration

5. After placing the pH electrode in the buffer solution, press the  key.
6. The selected buffer standard appears on the meter screen and meter starts checking various calibration values with a blinking  on screen.
7. Wait for the  to stabilize (stable calibration reading).
8. Press the **ENT**  key to confirm and save calibration data.
9. Meter displays **DONE** indicating end of the pH calibration procedure.
10. Repeat for other calibration points as required.

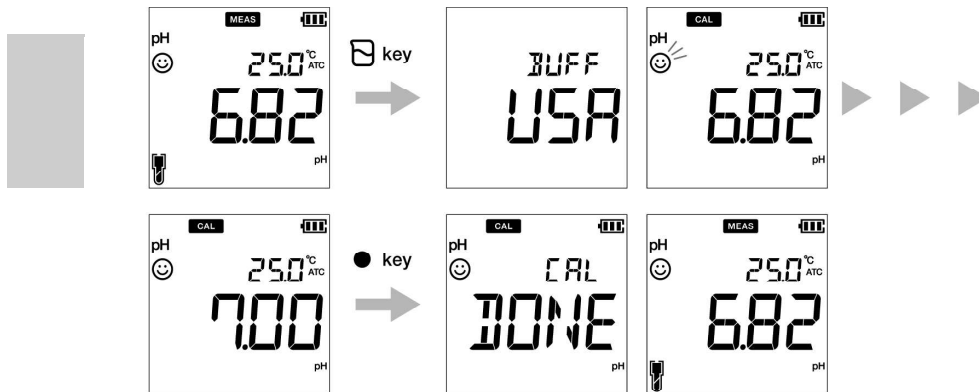

Note

If you want to know previous calibrated values, press the  key when you are in the **CAL** mode. The display scrolls through the calibrated values and indicates slope and offset values.

- **ORP/mV Calibration**

Calibration is necessary for accurate ORP measurement. To perform ORP calibration, follow the procedure detailed below:

Prerequisites

Clean the ORP electrode with DI (deionized) water and wipe it with tissue paper.

Switch on the PD meter and plug in the ORP electrode.

Prepare buffer solution required for calibration.

Ensure that the meter is in mV measurement mode.

Dip the ORP electrode into the standard solution ensuring that the solution level is at least 3 cm from the electrode tip.

Note

Absolute value measurement mode and relative value measurement mode are the two types of measurement mode available for ORP (mV) measurement.

In absolute value measurement mode, the handheld meter displays the actual voltage value.

In relative value measurement mode, user can adjust the absolute mV value by calibration.

If the mV value is adjusted, the meter automatically indicates relative mV value as **RmV**.

The adjustment mV is applied as an offset to the absolute mV value.







In the relative mV mode, the absolute mV value can be adjusted by ± 200 mV.

Tip

To abort an ongoing calibration process at any point of time, press the  key.

ORP calibration

Calibration

11. After placing the electrode in the solution, press the  key to switch to mV mode.
12. Press the  key.
13. Meter starts reading mV values and the  blinks until value stabilizes.
14. Wait for the  to stabilize (stable calibration reading).
15. Use the   keys to adjust the mV value to your desired value.
16. Press the **ENT**  key to confirm and save calibration data.
17. Meter displays **DONE** that indicates end of the ORP/mV calibration procedure.

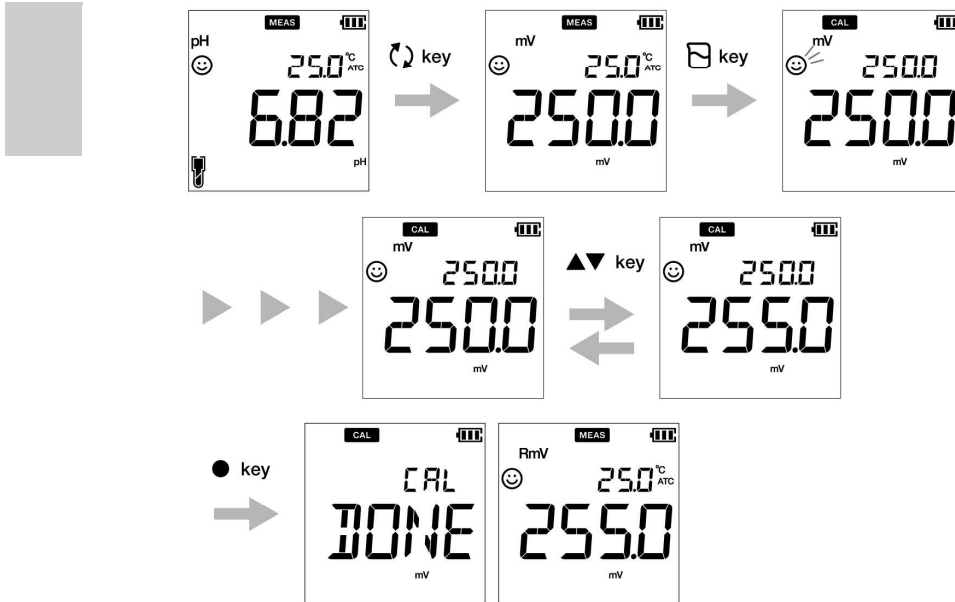

- **DO Calibration**

Calibration is necessary for accurate dissolved oxygen measurement. Two DO calibration modes are available in PD meter for calibration,

- Saturated oxygen concentration mode (%)
- Dissolved oxygen measurement mode (mg/L)

To perform various DO calibrations, follow the procedures detailed below:

Note

Set the air pressure value (default setup is 101.3 kPa) before calibration for accurate measurement.

- **Calibration in saturated oxygen concentration mode (%)**

Prerequisites

Clean the membrane at the tip of the DO electrode with DI (deionized) water and wipe it with tissue paper.

Switch on the PD meter and plug in the DO electrode.

Press the  key to keep the PD meter in saturated oxygen concentration mode (%) mode.

Note





Calibration performed in clean air is referred as air calibration.
Perform the air calibration in clean air at a location not subjected to dramatic temperature change, rain or direct wind.
Do not hold the tip of DO electrode with hand during calibration, as the electrode may be affected by temperature causing instability in calibration value.

Tip

To abort an ongoing calibration process at any point of time, press the  key.

DO calibration

• Air calibration



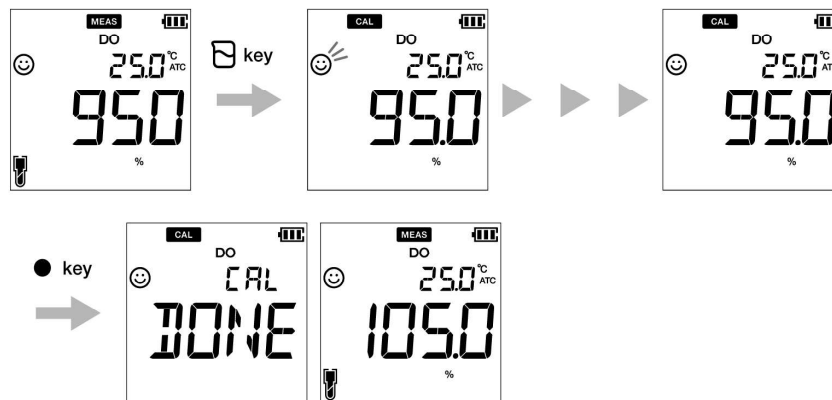

18. Hold the DO electrode still in clean air.
19. Press the  key. Meter starts checking various calibration values with a blinking  on screen.
20. Wait for the  to stabilize (stable calibration reading).
21. Press the **ENT**  key to confirm and save calibration data.
22. Meter displays **DONE** indicating end of the air calibration procedure.

Note

The electrode responds slightly differently to atmospheric air as compared to water. As such, 100% calibration in air will be shown as approximately 105%. Don't be alarmed by this. The reading in water will be accurate.



- **Zero calibration**

1. Dip the DO electrode in the zero standard solution.
2. Press the  key. Meter starts checking various calibration values with a blinking  on screen.
3. Wait for the  to stabilize (stable calibration reading).
4. Press the  key again to move to Zero Calibration mode.
5. Press the **ENT**  key to confirm and save calibration data.
6. Meter displays **DONE** indicating end of the zero calibration procedure.

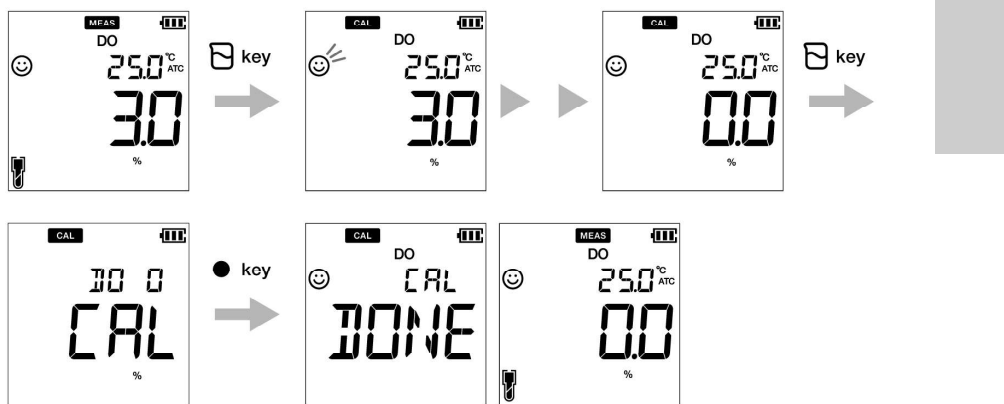

Note

Calibration performed with zero standard solution is referred as zero calibration. Prepare zero standard solution by adding 50 g sodium sulfite (Na_2SO_3) to 1000 mL deionized water and stirring the mixture to completely dissolve the Na_2SO_3 .

DO calibration

- **Calibration in dissolved oxygen measurement mode (mg/L)**

Prerequisites

Clean the membrane at the tip of the DO electrode with DI (deionized) water and wipe it with tissue paper.

Prepare required standard solutions (high-concentration and low-concentration solutions).

Switch on the PD meter and plug in the DO electrode.

Dip the DO electrode at least 6 cm in the standard solution.

Press the  key to keep the PD meter in dissolved oxygen measurement mode (mg/L) mode.

Note

Calibrate in the dissolved oxygen measurement mode in the order from high-concentration solution to a low-concentration solution.







User can adjust the measured dissolved oxygen reading by calibration and the adjusted value is applied as an off set to the actual measurement.

Prepare high-concentration solution by aerating a sample of fresh water for about 2 hours.

Tip

To abort an ongoing calibration process at any point of time, press the  key.





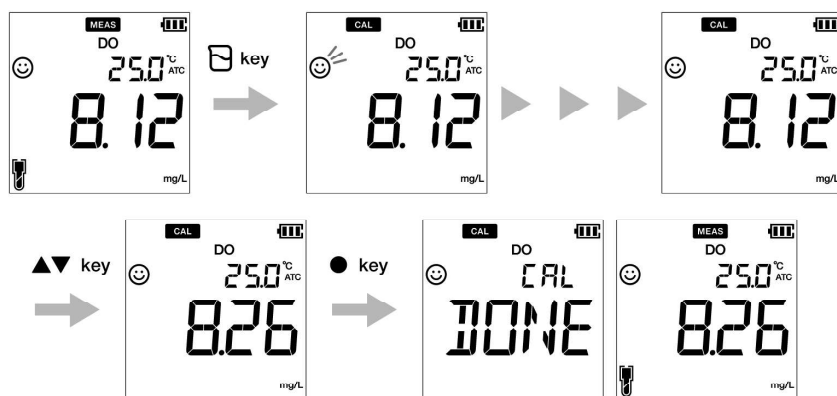

- **1st point calibration**

1. After placing the DO electrode in the high concentration solution, press the  key.
Meter starts checking various calibration values with a blinking  on screen.
2. Wait for the  to stabilize (stable calibration reading).
3. Use the   keys to adjust the DO reading.
4. Press the **ENT**  key to confirm and save calibration data.
5. Meter displays **CAL DONE** indicating end of the calibration procedure.



DO calibration

• 2nd point calibration

1. After placing the DO electrode in the low concentration solution (zero standard solution), press the  key. Meter starts checking various calibration values with a blinking  on screen.
2. Wait for the  to stabilize (stable calibration reading).
3. Press the  key again to move to Zero Calibration Mode.
4. Use the   keys to adjust the DO reading.
5. Press the **ENT**  key to confirm and save calibration data.
6. Meter displays **CAL DONE** indicating end of the calibration procedure.

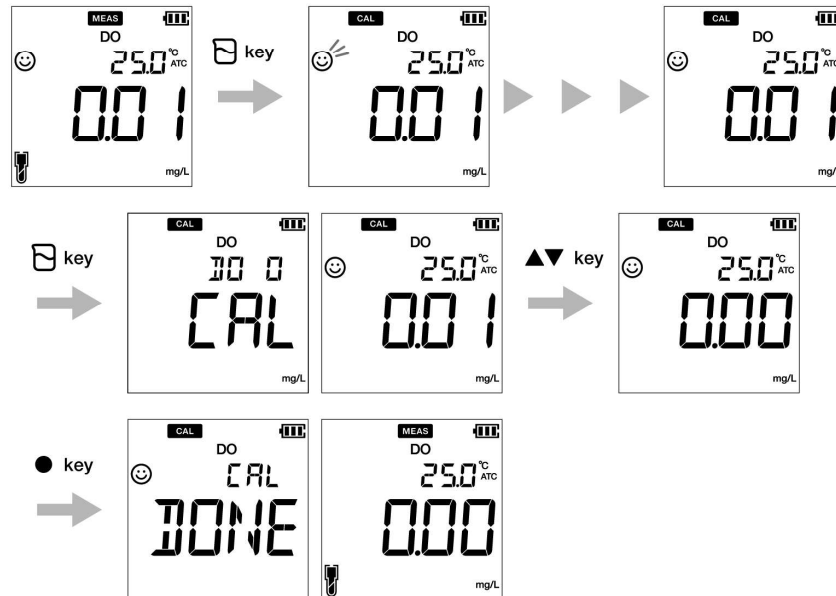

- **Temperature Calibration**

Temperature calibration is required to accurately match pH or DO electrode to the meter. Check the temperature reading and if its acceptable, no temperature calibration is required. If you need to calibrate, please follow the procedure detailed below:

Prerequisites

Clean the pH or DO electrode with DI (deionized) water and wipe it with tissue paper.
Switch on the PD meter and plug in any of the electrodes and the temperature sensor.
Dip the electrode in any calibrating solution till its temperature sensor is immersed.
Wait for 5 minutes to ensure temperature stability.

Note





Meter displays **MTC** if the temperature sensor is not plugged in and displays **ATC** if the temperature sensor is plugged in.
Temperature calibration must be performed using a known temperature solution or against a calibrated thermometer.

Tip

To abort an ongoing calibration process at any point of time, press the  key.

Temperature calibration

Calibration

7. After placing the electrode in the solution, press the  key.
8. Press the  key to switch to temperature calibration mode. Meter displays measured temperature value.
9. Use the   keys to adjust the temperature to the required value.
10. Press the **ENT**  key to save calibration data.
11. Meter displays **DONE** indicating end of the temperature calibration procedure.

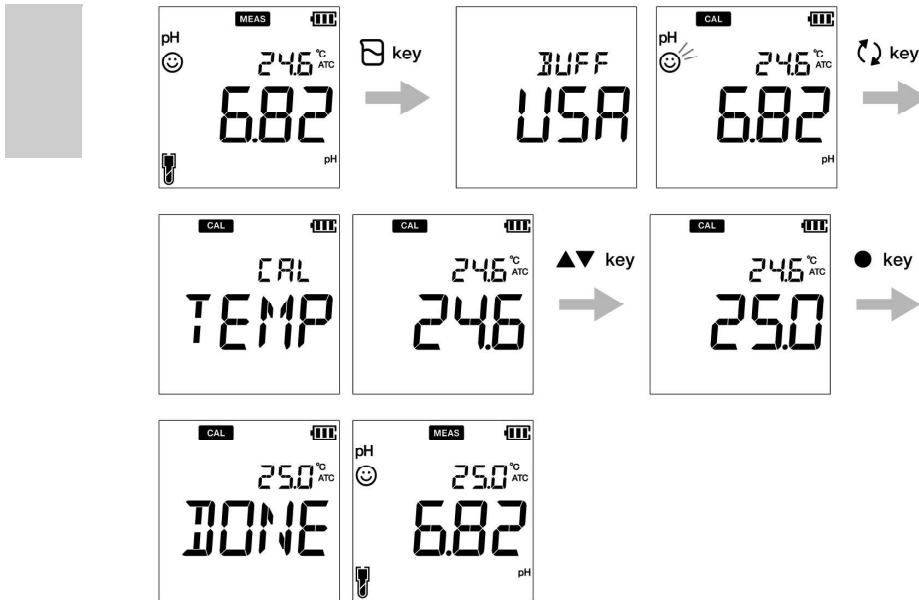

■ Data

This section describes the basic method of data transferring using OAKTON 200 series Handheld meters.

● Data capture and storage

In OAKTON PD200 series Handheld meters, data measured by the instrument can be stored in the internal memory.

To save the measured data:

Press the **ENT**  key to save the displayed data.

Meter displays the saved data for 2 seconds and then the display returns to the previous screen automatically.

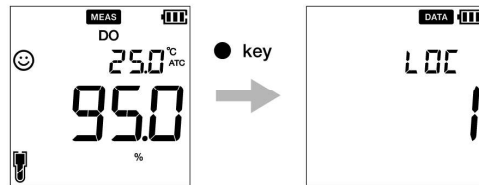

Note

If the data storage limit reaches 500 in PD250 model or 1000 in PD260 model, memory full error occurs and **MEM FULL** is displayed.

In such case, print the data or transfer necessary data to a PC (only for PD260) and delete the data from the internal memory of the instrument.

Viewing stored data

To view stored data, press  key .

Use   keys to review different stored records.

Press  key to return to measurement mode.

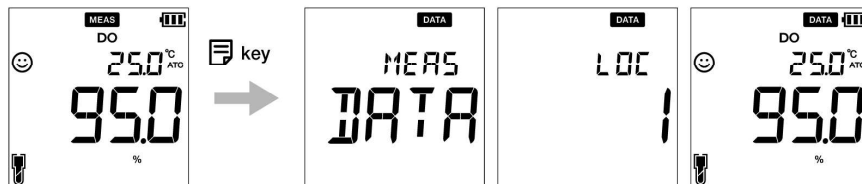

Data capture and storage





- **Data transfer**

- **Transfer data to PC**

Connect the instrument to a PC using the phono plug to USB cable to transfer saved data to the PC (for OAKTON PD260 only). Connect the phono jack at the instrument side to the communication port on the PC.

- **Print data**

To print a desired data set:

12. When the instrument is in the measurement mode, press  key.
13. Use   keys to view desired stored data.
14. Press  key to print that individual data.

- **Printer format- measurement**

Meter Model	: OAKTON PD260
Serial Number	: 123456789
SW Revision	: 1.00
User Name	:
Signature	:
Logged Data	
Location	: 2
Date	: 10 Aug 2018
Time	: 10:10:28
Mode	: pH
pH	: 7.00 pH
mV	: 0.0 mV
Temperature	: 25.0 C (MAN)
Electrode Status	: Excellent
Location	: 1
Date	: 10 Aug 2018
Time	: 10:09:28
Mode	: mV
mV	: 178.0 mV
Temperature	: 25.0 C (MAN)

Tip

To print entire stored data log, refer P 2.2 Print data setup on page 36.

■ Setup

This section describes all the setup functions available in OAKTON PD200 series Handheld meters.

● P1 pH setup

Using P1 pH setup function of the meter, you can:

- Select buffer standard
- Set calibration alarm
- Erase calibration data

To set the pH functions using OAKTON PD200 series Handheld meters, follow the procedure detailed below:

Prerequisites

Switch on the PD meter.

Note

Default buffer setup is **BUFF USA**. You can change it to **BUFF NIST** or **BUFF DIN** if required.

Calibration alarm setup option must be used to avoid Calibration interval alarm error on page 57 . You can set the calibration alarm for ---- day to upto 90 days, where ---- indicates no calibration alarm has been set.







Erasing previous calibration data is recommended for accurate calibration. Default setup is **NO** but to erase the calibration data, you need to change the setup to **YES**.

Tip

To return to the measurement mode, press the  key.





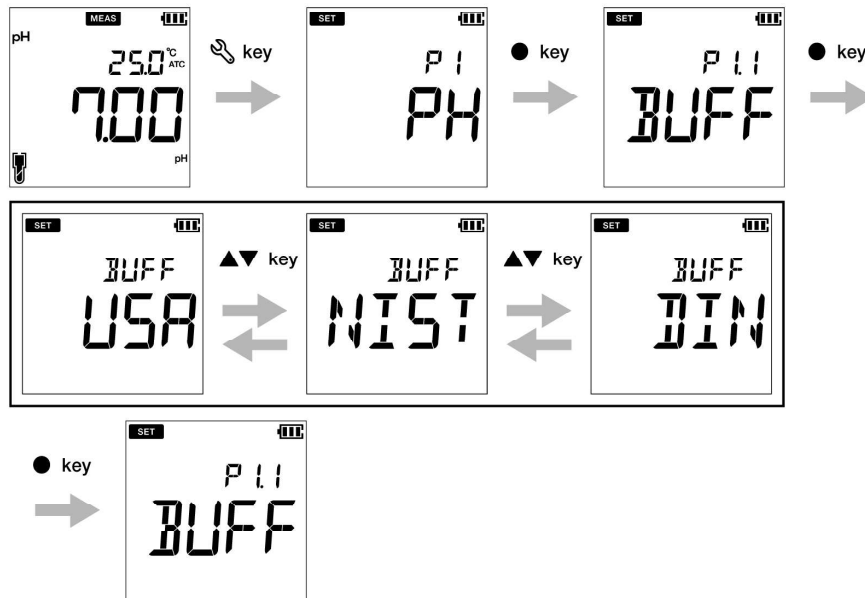

pH set up

• P 1.1 Buffer selection

15. Press the  key, P1 PH screen appears.
16. Press the **ENT**  key, P1.1 BUFF screen appears.
17. Press the **ENT**  key, by default **BUFF USA** appears.
18. Use the   keys to change the buffer standard to **BUFF NIST** or **BUFF DIN**.
19. Press the **ENT**  key, P1.1 BUFF screen appears. This indicates completion of buffer selection.







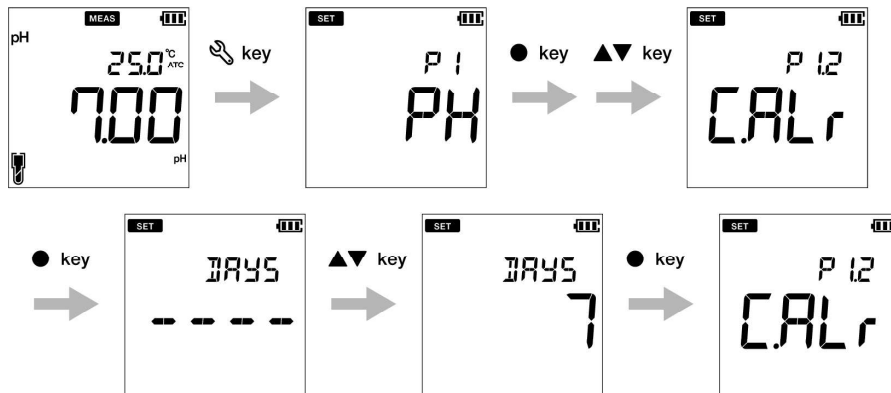



• P 1.2 Calibration alarm setup

1. Press the  key, **P1 PH** screen appears.
2. Press the **ENT**  key, **P1.1 BUFF** screen appears.
3. Press the  key, **P1.2 C.ALr** screen appears.
4. Press the **ENT**  key, by default **DAYS ----** appears.
5. Use the   keys to adjust the calibration alarm interval for next calibration.
6. Press the **ENT**  key, **P1.2 C.ALr** screen appears. This indicates completion of calibration alarm setup.



pH set up

• P 1.3 Erase calibration data

1. Press the  key, **P1 PH** screen appears.
2. Press the **ENT**  key, **P1.1 BUFF** screen appears.
3. Press the  key, **P1.2 C.ALr** screen appears.
4. Press the  key, **P1.3 C.CLr** appears.
5. Press the **ENT**  key, **C.CLr NO** screen appears with **NO** as default setup.
6. Use the   keys to change the setup to **YES**. This erases the calibration data.
7. Press the **ENT**  key. **P1.3 C.CLr** screen appears. This indicates erasure of calibration data.

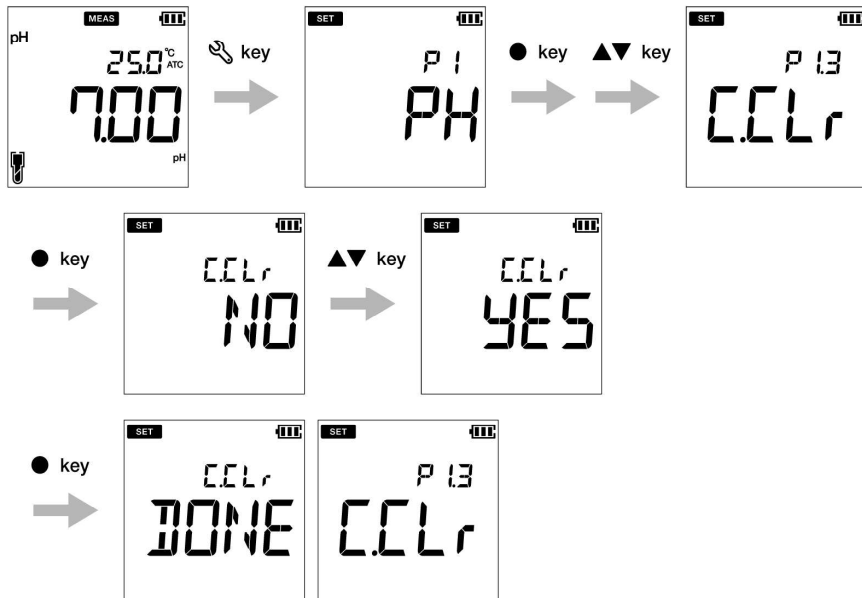

• **P1 DO setup**

Using P1 DO setup function of the meter, you can:

- Set salinity value
- Set barometric pressure
- Erase calibration data

To set the DO functions using OAKTON PD200 series Handheld meters, follow the procedure detailed below:

Prerequisites

Switch on the PD meter.

Note

Default salinity value is **0.0 ppt**. You can set a value in between 0.0 to 40.0 ppt.

Default barometric pressure is **101.3 kPa**. You can set a value in between 10.0 to 200.0 kPa.







Erasing previous calibration data is recommended for accurate calibration. Default setup is **NO** but to erase the calibration data, you need to change the setup to **YES**.

Tip

To return to the measurement mode, press the  key.





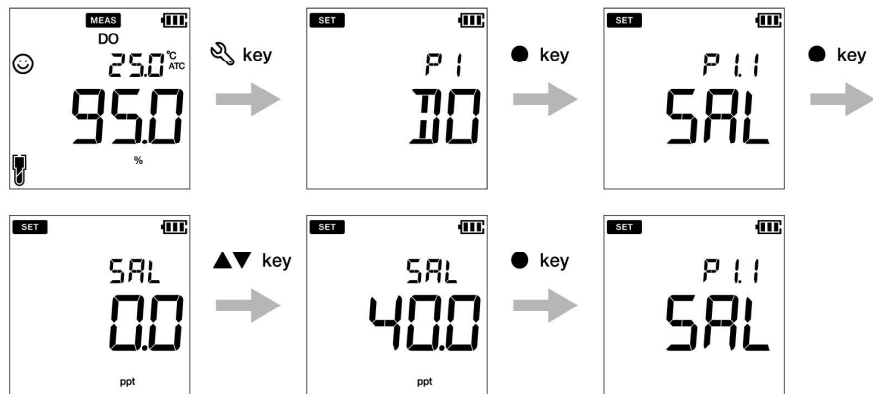

DO set up

- **P1.1 Salinity value setup**

8. Press the  key, **P1 DO** screen appears.
9. Press the **ENT**  key, **P1.1 SAL** screen appears.
10. Press the **ENT**  key, by default **SAL 0.0 ppt** appears.
11. Use the   keys to adjust the salinity value in between 0.0 to 40.0 ppt.
12. Press the **ENT**  key, **P1.1 SAL** screen appears. This indicates completion of salinity value setup.







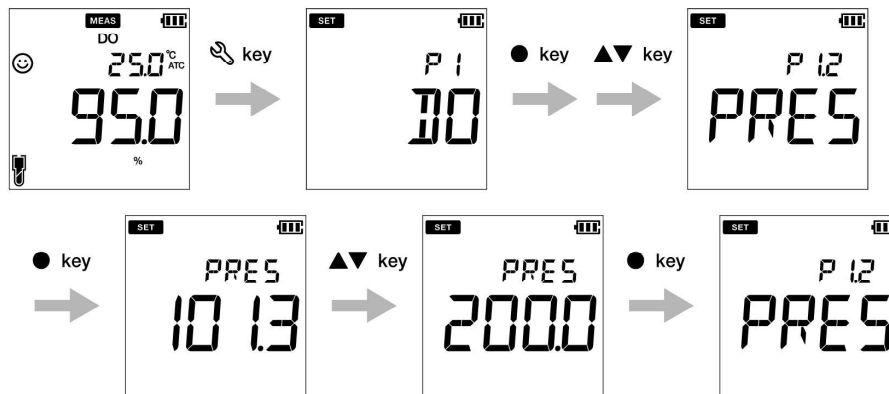



- **P1.2 Barometric pressure setup**

1. Press the  key, **P1 DO** screen appears.
2. Press the **ENT**  key, **P1.1 SAL** screen appears.
3. Press the  key, **P1.2 PRES** screen appears.
4. Press the **ENT**  key, by default **PRES 101.3** appears.
5. Use the   keys to adjust the barometric pressure in between 10.0 to 200.0 kPa.
6. Press the **ENT**  key, **P1.2 PRES** screen appears. This indicates completion of barometric pressure setup.



DO set up

• P1.3 Erase calibration data

1. Press the  key, P1 DO screen appears.
2. Press the ENT  key, P1.1 SAL screen appears.
3. Press the  key, P1.2 PRESS screen appears.
4. Press the  key, P1.3 C.CLr appears.
5. Press the ENT  key, C.CLr NO screen appears with NO as default setup.
6. Use the   keys to change the setup to YES. This erases the calibration data.
7. Press the ENT  key. P1.3 C.CLr screen appears. This indicates erasure of calibration data.

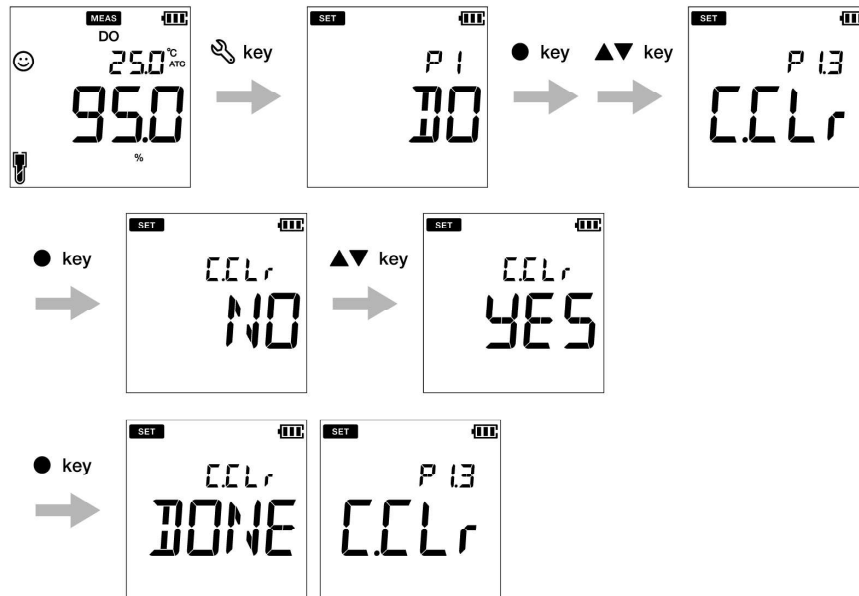

- **P2 Data setup**

Using P2 Data setup function of the meter, you can:

- Set data log interval
- Print data log
- Erase data log

To set the data functions using OAKTON PD200 series Handheld meters, follow the procedure detailed below:

Prerequisites

- Switch on the PD meter.
- Keep the meter either in pH or DO mode.

Note







Data setup procedure is common in both pH and DO mode with different meter screen display based on available setup sequence.
Default data log interval is ----, where ---- indicates no data log interval has been set.
Data log interval can be set from 2 to 999 seconds.

Tip

To return to the measurement mode, press the  key.

Data set up

• P 2.1 Data log interval setup

8. Press the  key, P1 PH/DO screen appears.
9. Press the  key, P2 DATA screen appears.
10. Press the **ENT**  key, P2.1 LOG screen appears.
11. Press the **ENT**  key, previously set log interval appears.
12. Use the   keys to sets the data log interval.
13. Press the **ENT**  key, P2.1 LOG screen appears. This indicates completion of data log interval setup.

pH mode

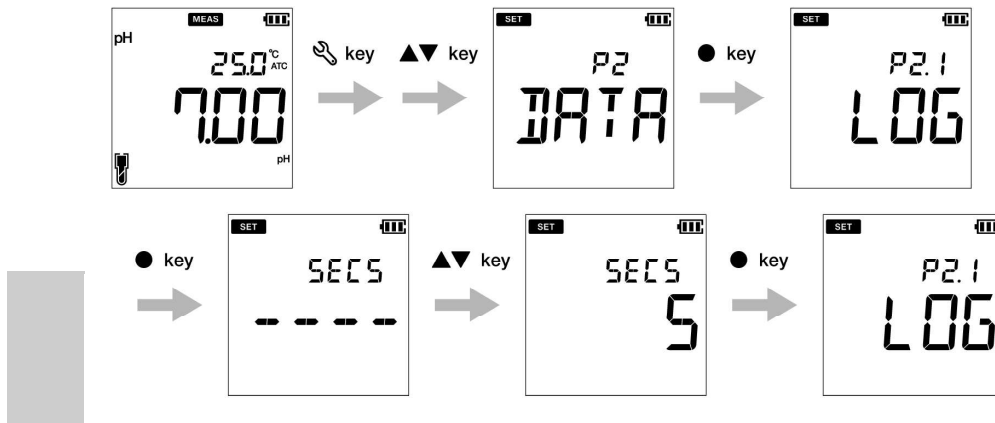



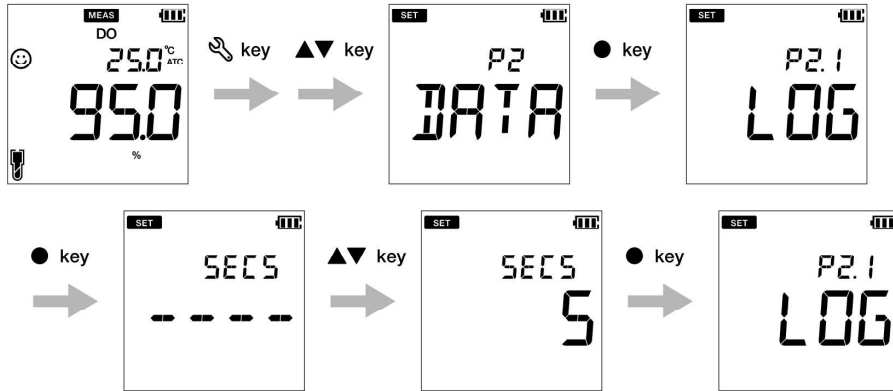





DO mode



Data set up

• P 2.2 Print data setup

1. Press the  key, **P1 PH/DO** screen appears.
2. Press the  key, **P2 DATA** screen appears.
3. Press the **ENT**  key, **P2.1 LOG** screen appears.
4. Press the  key, **P2.2 PrNT** screen appears.
5. Press the **ENT**  key, default setup is **NO**.
6. Use the   keys to change the setup to **YES**.
7. Press the **ENT**  key, **P2.2 PrNT** screen appears. This indicates completion of the print data.

pH mode

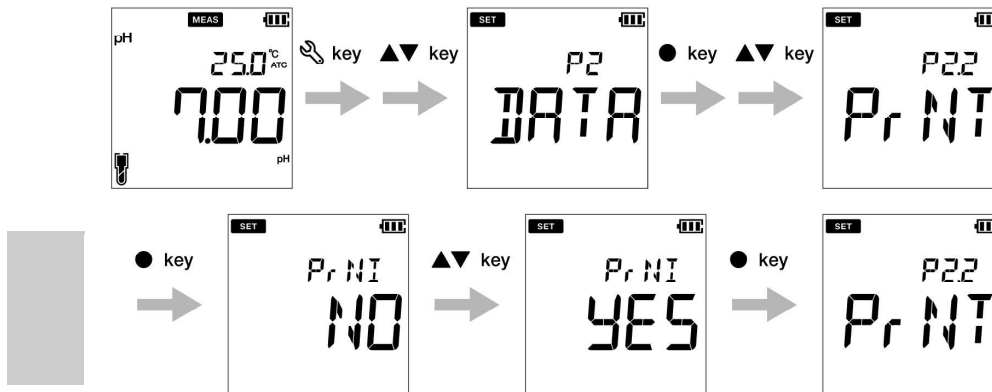



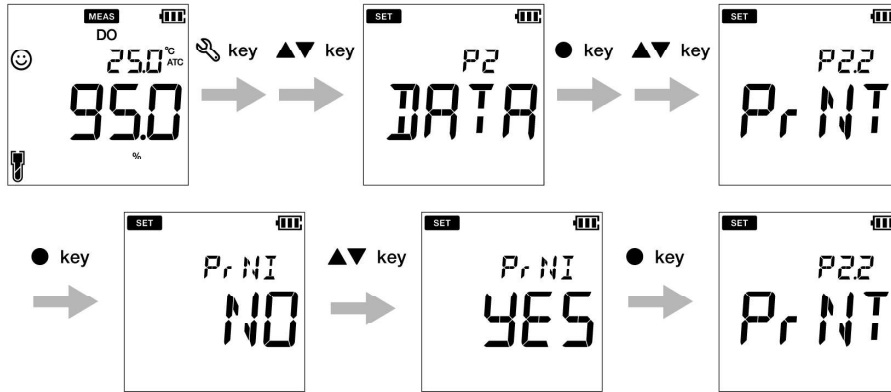





DO mode



Data set up

• P2.3 Erase data

1. Press the  key, **P1 PH/DO** screen appears.
2. Press  key, **P2 DATA** screen appears.
3. Press the **ENT**  key, **P2.1 LOG** screen appears.
4. Press the  key, **P2.2 PRNT** screen appears.
5. Press the  key, **P2.3 D.CLR** screen appears.
6. Press the **ENT**  key, default setup is **NO**.
7. Use the   keys set it to **YES** to erase all the data.
8. Press the **ENT**  key, **D.CLR DONE** screen appears briefly and then **P2.3 D.CLR** screen appears. This indicates completion of erasure of data.

pH mode

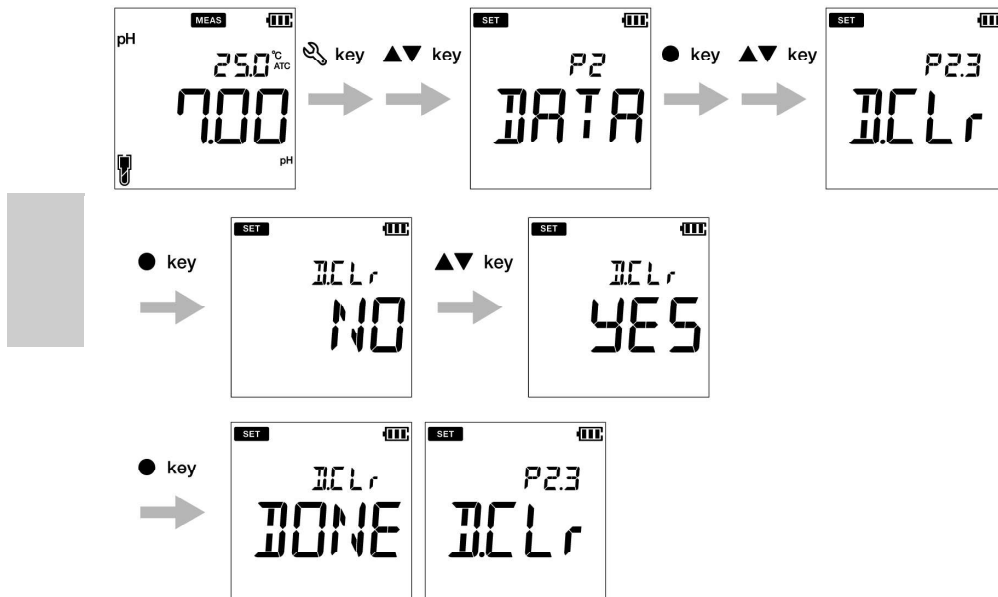

DO mode

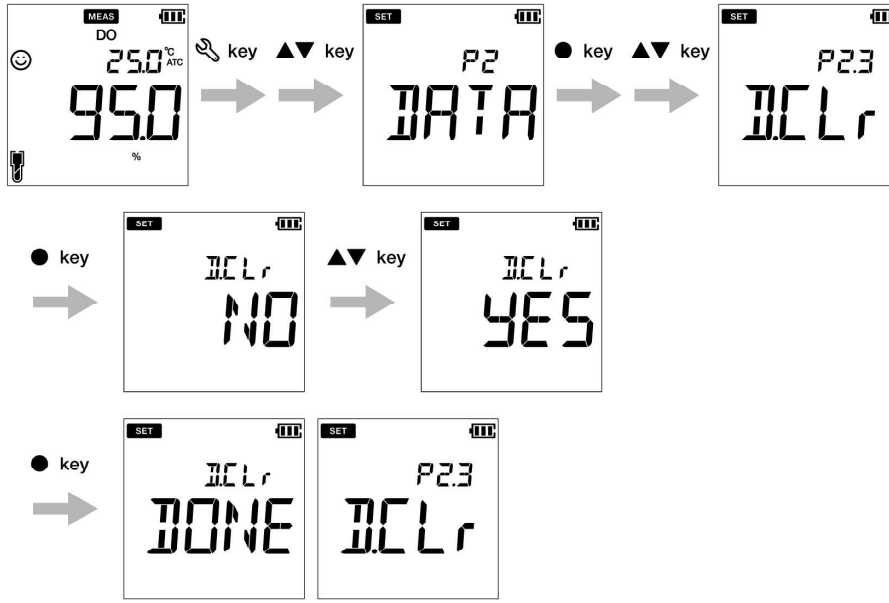

General set up

• P3 General setup

Using P3 General setup function of the meter, you can:

- Select stability mode of the meter
- Set auto shut-off time
- Select temperature measurement
- Reset the meter

To set the general functions using OAKTON PD200 series Handheld meters, follow the procedure detailed below:

Prerequisites

- Switch on the PD meter.
- Keep the meter either in pH or DO mode

Note

General setup procedure is common in both pH and DO mode with different meter screen display based on available setup sequence.

In the calibration mode, the auto stable (**AS**) mode is activated. Default stability setup in measurement mode is auto stable (**AS**). If you like, you can change it to auto hold (**AH**) or real time (**RT**).

Default auto shut-off time is 30 minutes. You can set the time from ---- to 30 minutes, where ---- indicates no auto shut-off time has been set and meter will be on continuously.

Default temperature unit is °C and you can change the unit to °F.

Default reset meter setup is **NO**. If you like to reset the meter, you can change it to **YES**.

Tip

Stability judgment criteria remains same for both auto stability mode and auto hold mode.









To return to the measurement mode, press the  key.

• P 3.1 Auto Stable, Auto Hold and Real Time mode setup

Auto Stable (AS) mode - the meter shows live readings ☺ annunciator blinks until the reading is stable.

Auto Hold (AH) mode - the meter locks the stable reading; ☺ annunciator blinks until reading is stable and then **HOLD** lights up.

Real Time (RT) mode - the meter shows live readings; Both ☺ and **HOLD** annunciators are inactive.

9. Press the  key, **P1 PH/DO** screen appears.
10. Press  key, **P2 DATA** screen appears.
11. Press  key, **P3 GEN** screen appears.
12. Press the **ENT**  key, **P3.1 STBL** screen appears.
13. Press the **ENT**  key, Default the stability mode is **AS** (auto stable).
14. Use the   keys to change the stability mode as **AH** (auto hold) or **RT** (real time).
15. Press the **ENT**  key, **P3.1 STBL** screen appears. This indicates completion of the stability mode selection.

pH mode

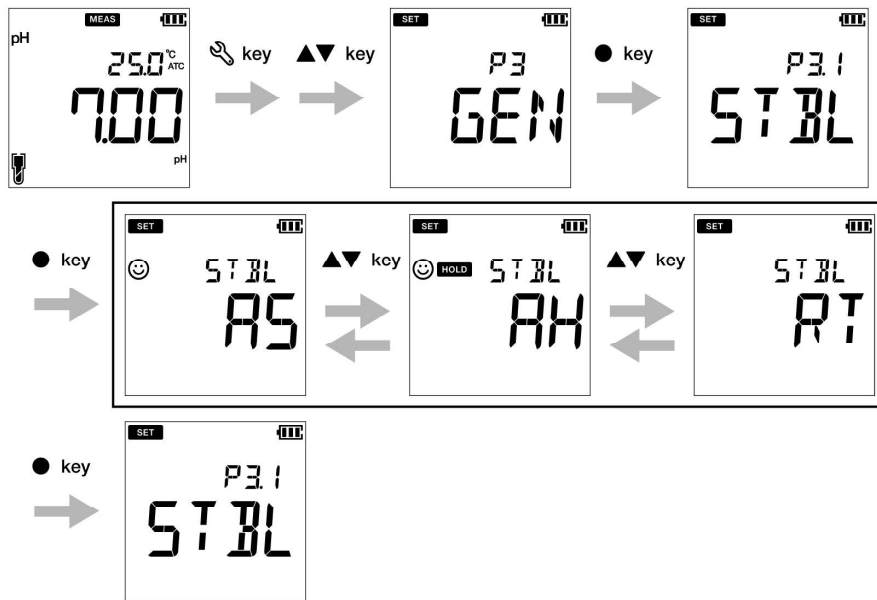





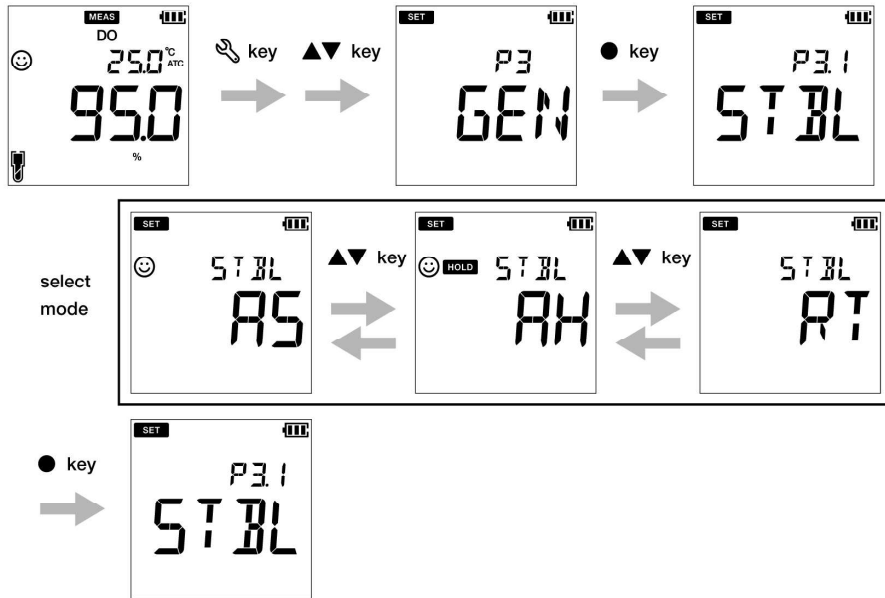



General set up

DO mode



● **P 3.2 Auto shut-off time setup**

1. Press the  key, **P1 PH/DO** screen appears.
2. Press the  key, **P2 DATA** screen appears.
3. Press the  key, **P3 GEN** screen appears.
4. Press the **ENT**  key, **P3.1 STBL** screen appears.
5. Press the  key, **P3.2 A.OFF** screen appears.
6. Press the **ENT**  key, default auto shut-off time is **30 minutes**.
7. Use the   keys to adjust the auto off time.
8. Press the **ENT**  key, **P3.2 A.OFF** screen appears. This indicates completion of the auto shut-off time setup.

Note

The default shut off time is 30 minutes. This can be adjusted from 1 minute to 30 minutes. If you set the display to ---- it indicates Auto Off is disabled. Meter will be on indefinitely till the user switches off the meter.

pH mode

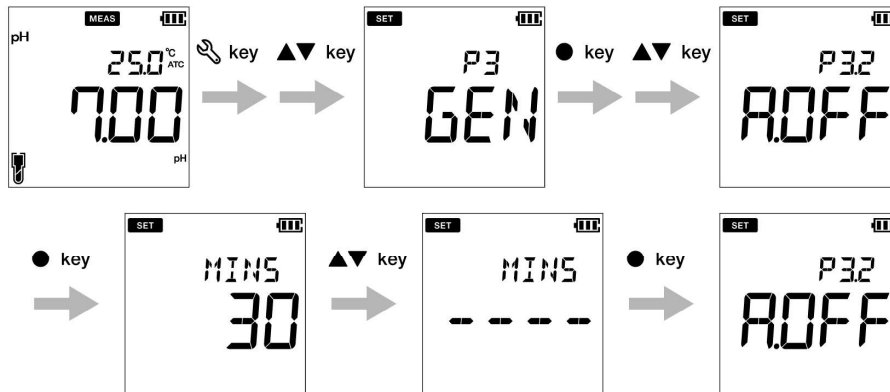





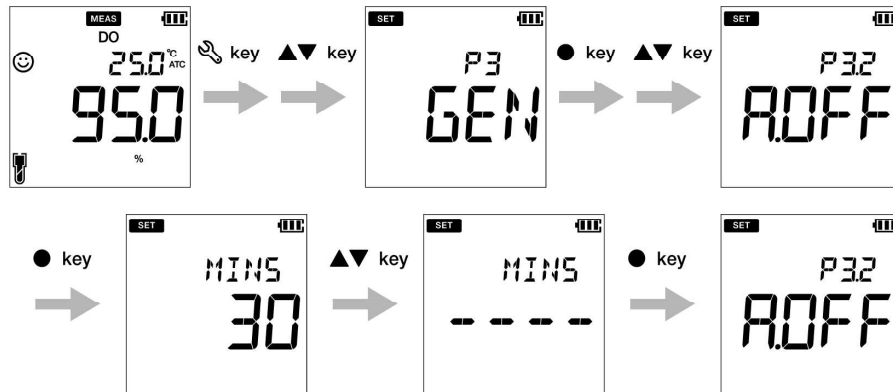





General set up

DO mode



● **P 3.3 Temperature unit setup**

1. Press the  key, **P1 PH/DO** screen appears.
2. Press the  key, **P2 DATA** screen appears.
3. Press the  key, **P3 GEN** screen appears.
4. Press the  key, **P3.1 STBL** screen appears.
5. Press the  key, **P3.2 A.OFF** screen appears.
6. Press the  key, **P3.3°C°F** screen appears.
7. Press the **ENT**  key, default temperature unit is **°C**.
8. Use the   keys to change the unit to **°F**.
9. Press the **ENT**  key, **P3.3°C°F** screen appears. This indicates completion of the end temperature unit selection.

pH mode

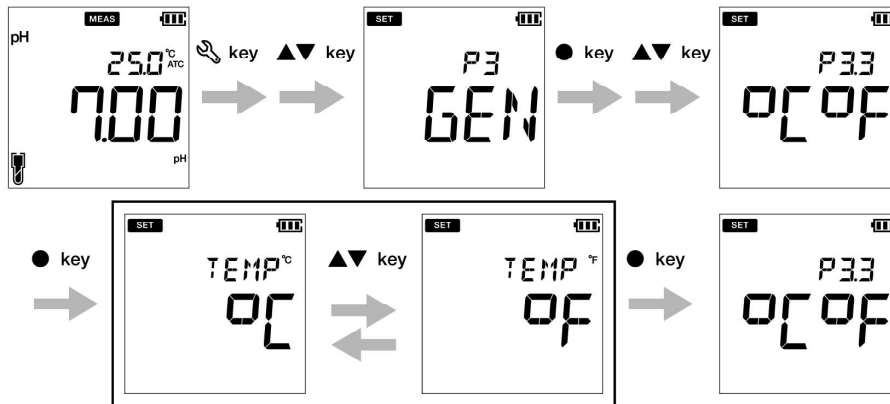





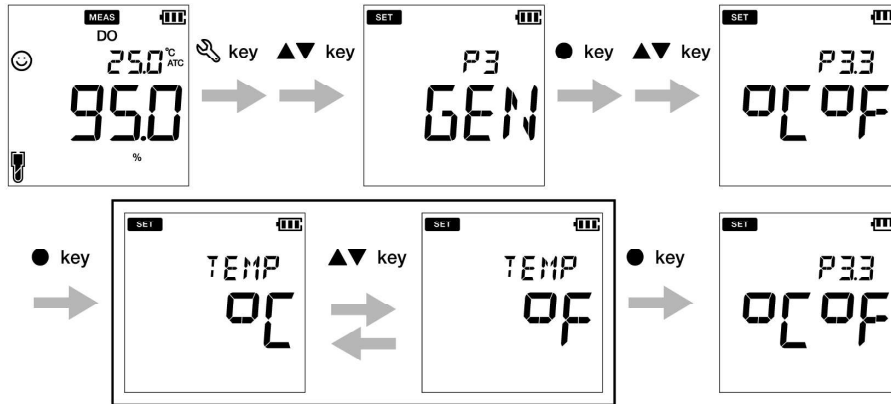





General set up

DO mode



● **P 3.4 Reset meter (factory default)**

1. Press the  key, **P1 PH/DO** screen appears.
2. Press the  key, **P2 DATA** screen appears.
3. Press the  key, **P3 GEN** screen appears.
4. Press the **ENT**  key, **P3.1 STBL** screen appears.
5. Press the  key, **P3.2 A.OFF** screen appears.
6. Press the  key, **P3.3 °C°F** screen appears.
7. Press the  key, **P3.4 r.SET** screen appears.
8. Press the **ENT**  key, default meter re-setup is **NO**.
9. Use the   key to set it **YES**.
10. Press the  key. Meter displays **DONE** and automatically switches off.

pH mode

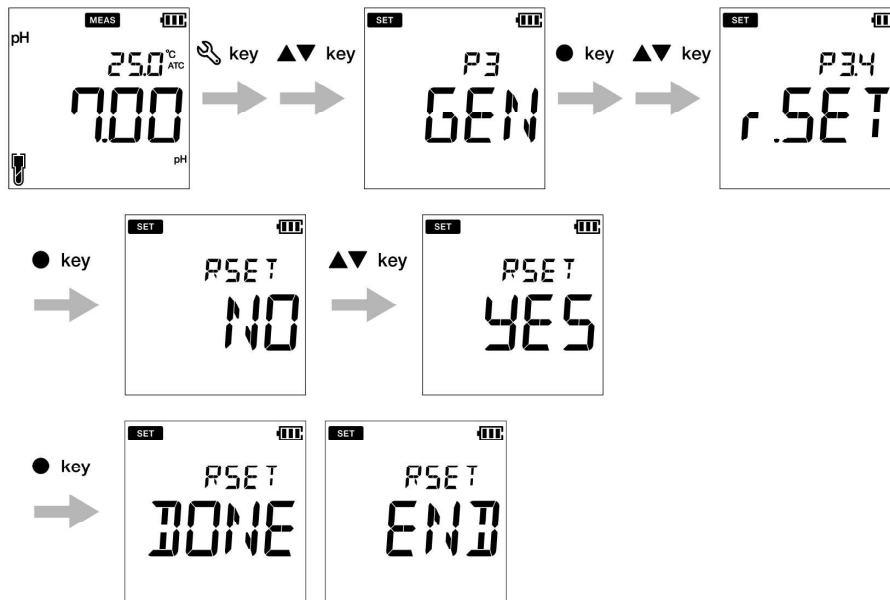

General set up

DO mode

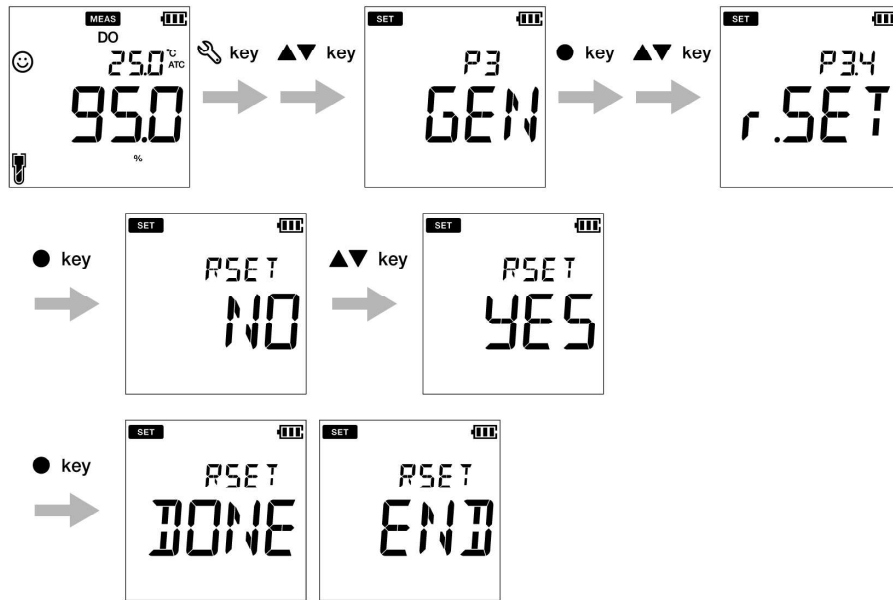

• **P4 CLK setup**

Real-time clock functionality is available only for OAKTON 260 meters. Using P4 Clock setup function of the meter, you can set:

- Date
- Time

To set the clock function using OAKTON PD260 handheld meter, follow the procedure detailed below:

Prerequisites

- Switch on the PD meter.
- Keep the meter either in pH or DO mode

Note















Clock setup procedure is common in both pH and DO mode with different meter screen display based on available setup sequence.
setup date and time is necessary before using the instrument for the first time or after replacing the batteries.
Set date and time data is captured correctly while saving data in the internal memory.

Tip

To return to the measurement mode, press the  key.

Clock set up

• P 4.1 Date setup

11. Press the  key, **P1 PH/DO** screen appears.
12. Press the  key, **P2 DATA** screen appears.
13. Press the  key, **P3 GEN** screen appears.
14. Press the  key, **P4 CLK** screen appears.
15. Press the **ENT**  key, **P4.1 DATE** screen appears.
16. Press the **ENT**  key, default set year appears.
17. Use the   keys to adjust the year,
18. Press the **ENT**  key, default set month appears.
19. Use the   keys to adjust the month.
20. Press the **ENT**  key, default set day appears.
21. Use the   keys to adjust the day.
22. Press the **ENT**  key, **P4.1 DATE** screen appears. This indicates completion of the date setup.

pH mode

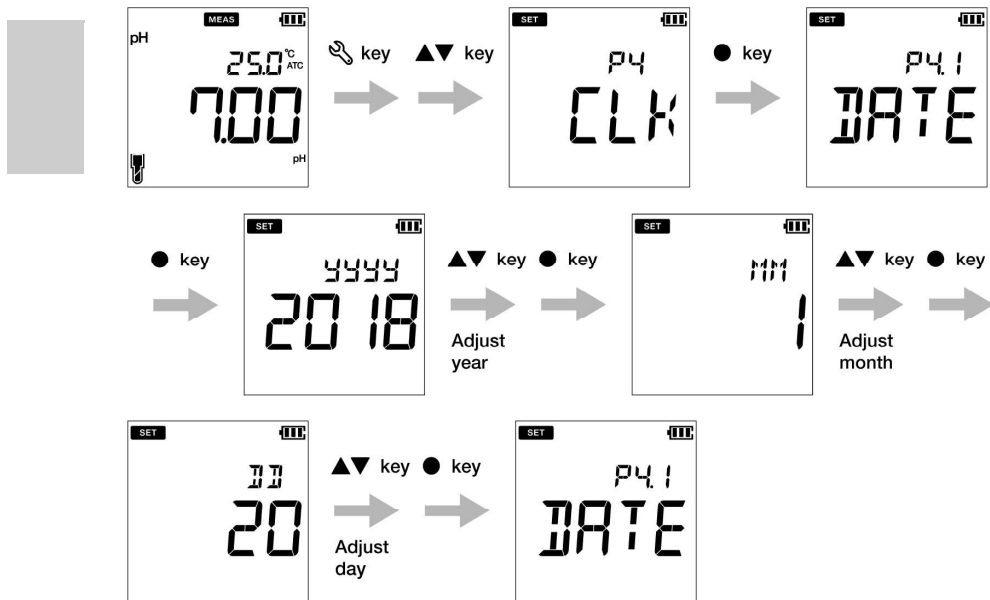



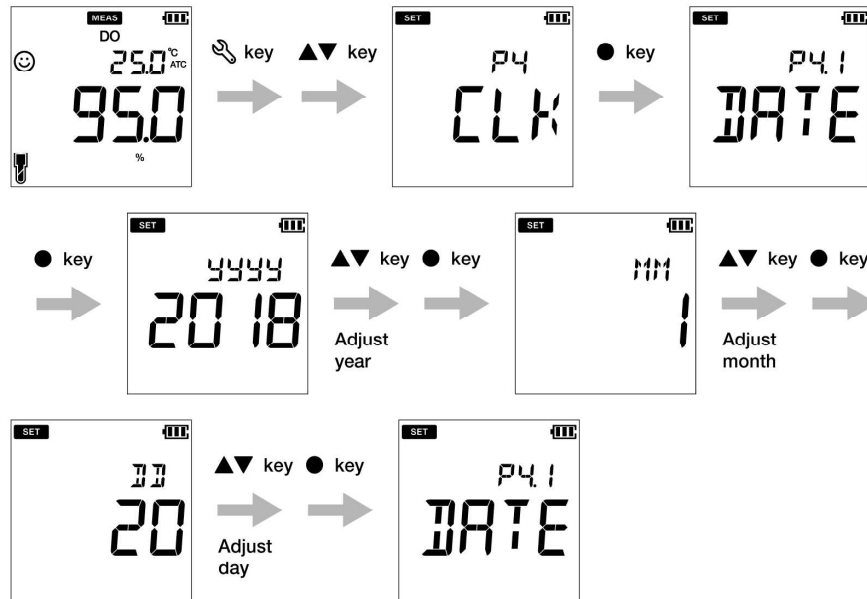









DO mode



Clock set up

• P 4.2 Time setup

1. Press the  key to switch to the setup mode, **P1 PH/DO** screen appears.
2. Press the  key, **P2 DATA** screen appears.
3. Press the  key, **P3 GEN** screen appears.
4. Press the  key, **P4 CLK** screen appears.
5. Press the **ENT**  key, **P4.1 DATE** screen appears.
6. Press the  key, **P4.2 TIME** screen appears.
7. Press the **ENT**  key, default set hour appears.
8. Use the   keys to adjust the hour.
9. Press **ENT**  key, default set minute appears.
10. Use the   keys to adjust the minute.
11. Press **ENT**  key, **P4.2 TIME** screen appears. This indicates completion of the time setup.

pH mode

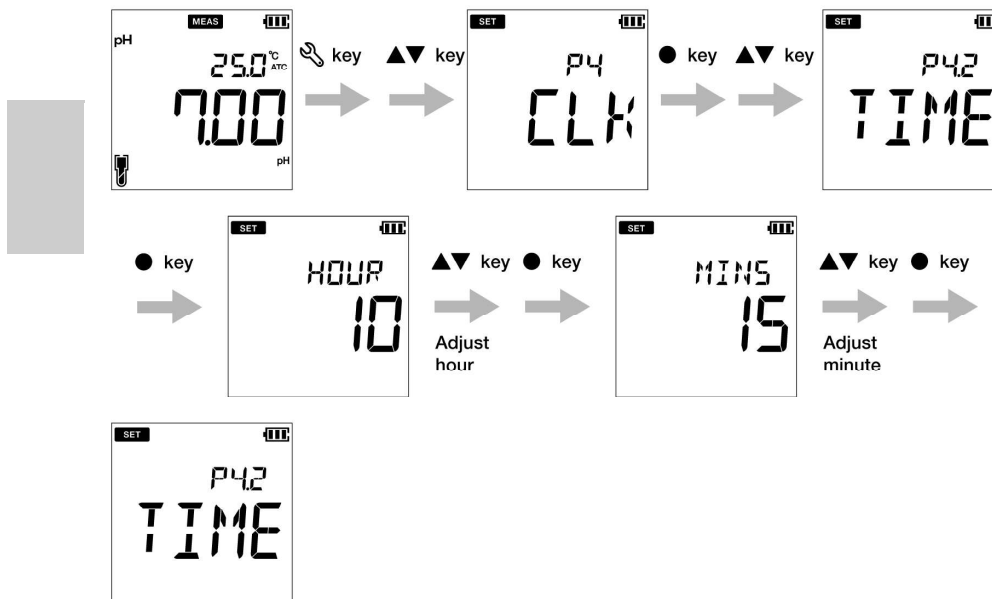

DO mode

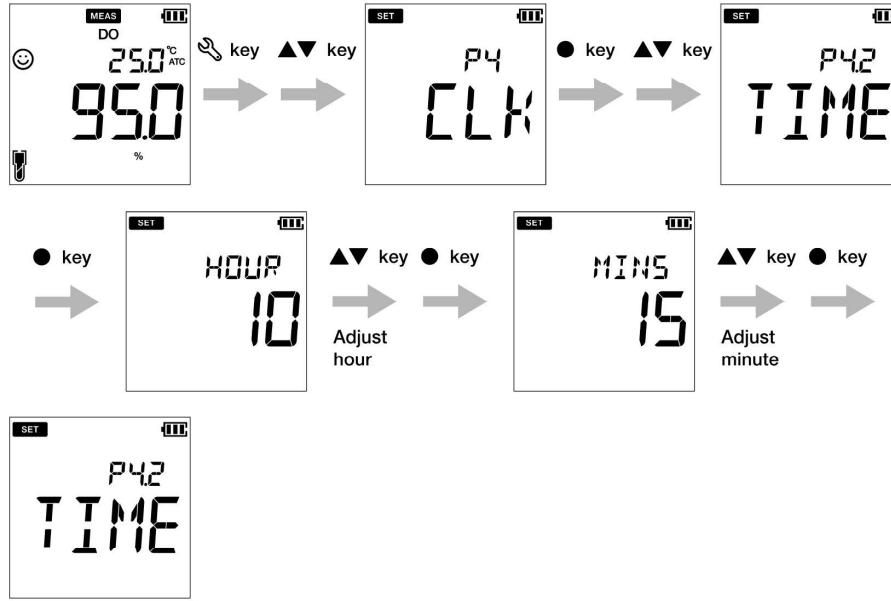

■ Maintenance and storage

This section describes maintenance of OAKTON 200 series Handheld meters, pH, ORP and DO electrodes used with the meter.

● Maintenance contract

Please contact your dealer for the product maintenance contract.

● Maintenance and storage of the instrument

● How to clean the instrument

If the instrument is dirty, wipe it gently with a soft dry cloth. If it is difficult to remove the dirt, wipe it gently with a cloth moistened with alcohol.

The instrument is made of solvent resistant materials but is not resistant to all chemicals. Do not dip the instrument in strong acid or alkali solution, or wipe it with such solutions.

Do not wipe the instrument with polishing powder or other abrasive compound.

● Environmental conditions for storage

Temperature: 0 °C to 45 °C

Humidity: under 80% relative humidity and free from condensation

● Avoid the following conditions:

Dusty place
Strong vibration
Direct sunlight
Corrosive gas environment
Close to an air-conditioner
Direct wind

- **Maintenance and storage of electrodes**

This section describes an overview of the procedures for maintenance and storage of pH, ORP and DO electrodes.

- **How to clean the pH and ORP electrodes**

Always clean the electrode with deionized water after every measurement. When the response is slow or residue from the sample adheres to the electrode, use the appropriate method below to clean the electrode, and then clean again with deionized water.

For pH electrode

Type of dirt	Cleaning solution
General	Diluted neutral cleaning solution
Oil	Alcohol, or diluted neutral cleaning solution
Inorganic substance	1 mol/L HCl or electrode cleaning solution
Protein	Cleaning solution including protein-removing enzyme
Alkali	Dip in 1 mol/L HCl or electrode cleaning solution for 1h to 2 h

For ORP electrode

Type of dirt	Cleaning solution
General	Dilute neutral cleaning solution (General dish washing liquid works reasonably well.)
Oil	
Inorganic substance	Immerse dilute nitric acid (1:1 nitric acid)

- **How to clean the membrane of DO electrode**

The membrane of DO electrode is extremely thin. Take care, not to tear the membrane when cleaning. Clean the membrane with deionized water and wipe it with a soft cloth, take care not to damage it.

Note

When using a neutral cleaning solution to clean the DO electrode, keep the neutral cleaning solution away from the membrane in order to prevent deterioration of the membrane.

Maintenance and storage

• Daily storage of the pH and ORP electrodes

If the electrode becomes dry, the response will be slow. Store in a moist atmosphere. Follow the steps below to properly store the electrodes even when the electrodes will not be used for a long period.

12. Wash the electrode well with pure water (or deionized water) to remove sample completely, and close the internal solution filler port.
13. Wash the inside of the protective cap with pure water (or deionized water), then add enough pure water (or deionized water) to soak the sponge.
14. Attach the protective cap.

• Daily storage of the DO electrode

Follow the steps below to store the electrode correctly.

9552-20D, 9552-50D

15. Clean the DO electrode well with deionized water.
16. Store electrode in carry case in a dry condition.

• When the DO electrode will not be used for a long time

Follow the steps below to store the electrode correctly.

9552-20D, 9552-50D

1. Clean the DO electrode well with tap water, then dry it with cotton gauze.
2. Remove the DO tip from the DO electrode.
3. Attach the socket on the DO tip, then store it in a cool, dark location.

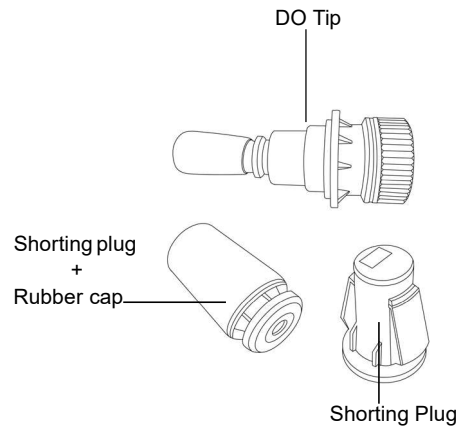



■ Error messages and trouble shooting

● Error message

This section describes the causes of typical errors and the actions to be taken to resolve respective errors.

If ERR is displayed while you are using the instrument, check the error, its cause and action to be taken in the error list below:

Meter display	ERR description	Cause of error and How to solve the problem
BATT LOW	Low battery	Battery power is low. Please replace with new batteries.
OFFS ERR	Offset voltage error	Electrode is dirty or reference junction is clogged. Clean the electrode.
SLPE ERR	Slope error	Electrode sensitivity is low. Please clean and recalibrate with fresh standard solution. If the problem persists, replace the electrode with new one.
BUFF ERR	Can not auto recognize standard solution	The instrument cannot identify the standard solution. Check the calibration solution and use fresh one if required.
	Calibration interval alarm error	Exceeds the calibration interval setup. Calibrate the meter.
MEM FULL	Memory data full	The number of the data saved has exceeded the specified number of items. Print or transfer the data. Or, clear stored data.
	If user selects the enter key before stable in calibration mode	● key is pressed before the calibration value has stabilized. Wait for the value to be stable and then press the ● key.

Error messages and trouble shooting

• Trouble shooting

This section describes causes and actions to take for problems that customers frequently ask.

The indicated value fluctuates

< Problem with the electrode >

Cause	How to solve problem
The electrode is dirty.	Clean the electrode.
The electrode is broken.	Replace the electrode.
The level of reference electrolyte gel.	Replace the electrode.

< Problem with the instrument >

Cause	How to solve problem
There is a motor or other device causing electrical interference.	Measure at a place where no influence from induction is given. Ground all AC-powered equipment.
The electrode is not connected correctly.	Connect the electrode properly.

< Problem with the sample >

Cause	How to solve problem
Electrode is not immersed enough to cover liquid junction.	The electrode must be immersed up to the liquid junction. As a guide, immerse to at least 3 cm from the tip of the electrode.
The stability of electrode is affected by the sample solution.	It is important to select an electrode that is appropriate for the sample. Consult your dealer. To confirm an electrode that is appropriate for the sample, check the pH electrode selection guide in our catalogue, or refer to our website.

Error messages and trouble shooting

The response is slow

Cause	How to solve problem
The electrode is dirty.	Clean the electrode.
The electrode is broken.	Replace the electrode.
The response of electrode is affected by the sample solution.	It is important to select an electrode that is appropriate for the sample. Consult your dealer. To confirm an electrode that is appropriate for the sample, check the pH electrode selection guide in our catalogue, or refer to our website.

The indicated value does not change

Cause	How to solve problem
The electrode is broken.	Replace the electrode.
The electrode is not connected correctly.	Connect the electrode correctly.
Keys are locked.	Turn OFF the power, remove the batteries, and then turn ON the power again.
The instrument is in HOLD state.	Cancel the HOLD state.
Instrument defect	Consult your dealer.

Error messages and trouble shooting

The measured value is out of the measurement range

When the measured value is below the display range, Ur appears. When the measured value is over the display range, Or appears.

Cause	How to solve problem
Sample is out of the measurement range.	Use a sample within the measurement range.
Electrode is not immersed enough to cover liquid junction.	The electrode must be immersed up to the liquid junction. As a guide, immerse to at least 3 cm from the tip of the electrode.
The electrode cable is broken.	Replace the electrode.
Calibration is not performed or performed incorrectly.	Perform calibration correctly.
Instrument defect	Check as explained below.

• How to check for instrument defect (pH mode)

Short the metal part of the outer tube to the center pin of the electrode connector of the corresponding channel of the instrument. If Ur or Or appears in this condition, consult your dealer.

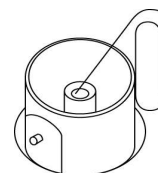

Repeatability of the measured value is poor

Cause	How to solve problem
Effect of the sample solution	Repeatability becomes poor when the pH or DO of the sample changes over time.
The electrode is dirty.	Clean the electrode.
The electrode is broken.	Replace the electrode.
The internal solution of the electrode is partially depleted or contaminated.	Replace the electrode.

Nothing appears when the power is turned ON

Cause	How to solve problem
Power is not supplied.	Insert batteries.
Battery polarity (+, -) is reversed.	Insert the batteries with the polarity (+, -) correctly oriented.
Battery life is low.	Replace the batteries.
Instrument defect	Consult your dealer.

Swelling of keypad

Cause	How to solve problem
Using the instrument at high elevation or other location where the air pressure is different from sea level.	To eliminate the pressure difference between the inside and outside of the instrument, briefly open and then close the serial connector and battery cover. After opening, correctly close the cover to maintain dust and water proofing.
Instrument defect	Consult your dealer.

Part of the display is missing

Cause	How to solve problem
Instrument defect	Check the display by switching ON the instrument when all the LCD segments are lit.

■ **Appendix**

● **Appendix 1**

This section describes technical information and option for OAKTON 200 series Handheld meters.

The pH vs. temperature values for the various standards are listed below:

< USA >

Temp. (°C)	pH 1.68	pH 4.01	pH 7.00	pH 10.01	pH 12.46
0	1.67	4.01	7.12	10.32	
5	1.67	4.01	7.09	10.25	13.25
10	1.67	4.00	7.06	10.18	13.03
15	1.67	4.00	7.04	10.12	
20	1.68	4.00	7.02	10.06	12.64
25	1.68	4.01	7.00	10.01	12.46
30	1.69	4.01	6.98	9.97	12.29
35	1.69	4.02	6.98	9.93	
40	1.70	4.03	6.97	9.89	11.99
45	1.70	4.04	6.97	9.86	
50	1.71	4.06	6.97	9.83	11.73
55	1.72	4.08	6.97	9.81	



< NIST >

Temp. (°C)	pH 1.68	pH 4.01	pH 6.86	pH 9.18	pH 12.46
0	1.67	4.00	6.98	9.46	
5	1.67	4.00	6.95	9.39	13.25
10	1.67	4.00	6.92	9.33	13.03
15	1.67	4.00	6.90	9.27	
20	1.68	4.00	6.88	9.22	12.64
25	1.68	4.01	6.86	9.18	12.46
30	1.69	4.01	6.85	9.14	12.29
35	1.69	4.02	6.84	9.10	
40	1.70	4.03	6.84	9.04	11.99
45	1.70	4.04	6.83	9.04	
50	1.71	4.06	6.83	9.01	11.73
55	1.72	4.08	6.83	8.99	

< DIN >

Temp. (°C)	pH 1.09	pH 3.06	pH 4.65	pH 6.79	pH 9.23	pH 12.75
0	1.08	3.10	4.67	6.89	9.48	13.37
5	1.09	3.10	4.66	6.87	9.43	13.37
10	1.09	3.10	4.66	6.84	9.37	13.37
15	1.09	3.08	4.65	6.82	9.32	13.17
20	1.09	3.07	4.65	6.80	9.27	12.96
25	1.09	3.06	4.65	6.79	9.23	12.75
30	1.10	3.05	4.65	6.78	9.18	12.61
35	1.10	3.04	4.65	6.77	9.13	12.45
40	1.10	3.04	4.66	6.76	9.09	12.29
45	1.11	3.04	4.67	6.76	9.04	12.14
50	1.11	3.04	4.68	6.76	9.00	11.98
55	1.11	3.04	4.69	6.76	8.96	11.84

Technical note

• Saturated DO levels in water at various temperatures

ISO17289 (JIS K0102)

Temp. (°C)	Saturated DO (mg/L)	Temp. (°C)	Saturated DO (mg/L)	Temp. (°C)	Saturated DO (mg/L)	Temp. (°C)	Saturated DO (mg/L)
1	14.22	11	11.03	21	8.92	31	7.43
2	13.83	12	10.78	22	8.74	32	7.31
3	13.46	13	10.54	23	8.58	33	7.18
4	13.11	14	10.31	24	8.42	34	7.07
5	12.77	15	10.08	25	8.26	35	6.95
6	12.45	16	9.87	26	8.11	36	6.84
7	12.14	17	9.67	27	7.97	37	6.73
8	11.84	18	9.47	28	7.83	38	6.62
9	11.56	19	9.28	29	7.69	39	6.52
10	11.29	20	9.09	30	7.56	40	6.41

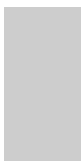

• Appendix 2**Printer format - Measurement****pH**

Meter Model	: OAKTON PD260
Serial Number	: 123456789
SW Revision	: 1.00
Date	: 20 Aug 2018
Time	: 10:10:28
Mode	: pH
pH	: 7.00 pH
mV	: 0.0 mV
Temperature	: 25.0 C (MAN)
Electrode Status	: Excellent
User Name	:
Signature	:

mV

Meter Model	: OAKTON PD260
Serial Number	: 123456789
SW Revision	: 1.00
Date	: 20 Aug 2018
Time	: 10:10:28
Mode	: mV
mV	: 0.0 mV
Temperature	: 25.0 C (MAN)
User Name	:
Signature	:

Printout summary

Relative mV

Meter Model	: OAKTON PD260
Serial Number	: 123456789
SW Revision	: 1.00
Date	: 20 Aug 2018
Time	: 10:10:28
Mode	: R. mV
R. mV	: 3.0 mV
Offset	: -3.0 mV
Temperature	: 25.0 C (MAN)
User Name	:
Signature	:

DO - mg/L

Meter Model	: OAKTON PD260
Serial Number	: 123456789
SW Revision	: 1.00
Date	: 20 Aug 2018
Time	: 10:10:28
Mode	: DO
DO	: 7.26 mg/L
Temperature	: 25.0 C (MAN)
Electrode Status	: Excellent
User Name	:
Signature	:

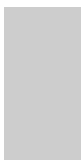

Do - %

Meter Model	: OAKTON PD260
Serial Number	: 123456789
SW Revision	: 1.00
Date	: 20 Aug 2018
Time	: 10:10:28
Mode	: Do
Do	: 100.0 %
Temperature	: 25.0 C (MAN)
Electrode Status	: Excellent
User Name	:
Signature	:

Printer format - Data log

Meter Model	: OAKTON PD260
Serial Number	: 123456789
SW Revision	: 1.00
User Name	:
Signature	:
Logged Data	
Location	: 2
Date	: 10 Aug 2018
Time	: 10:10:28
Mode	: pH
pH	: 7.00 pH
mV	: 0.0 mV
Temperature	: 25.0 C (MAN)
Electrode Status	: Excellent
Location	: 1
Date	: 10 Aug 2018
Time	: 10:09:28
Mode	: mV
mV	: 178.0 mV
Temperature	: 25.0 C (MAN)

Printout summary

Printer format - Calibration

PH

Meter Model	: OAKTON PD260
Serial Number	: 123456789
SW Revision	: 1.00
Date	: 20 Aug 2018
Time	: 10:10:28
Calibration data	
Cal Date	: 20 Jun 2018
Cal Time	: 10:10:10
Cal Points	: 4.01, 7.00, 10.01
Offset	: 0.0 mV
Avg Slope	: 98.2 %
Cal Temp.	: 25.0 C (ATC)
Electrode Status	: Excellent
User Name	:
Signature	:

DO (%)

Meter Model	: OAKTON PD260
Serial Number	: 123456789
SW Revision	: 1.00
Date	: 20 Aug 2018
Time	: 10:10:28
Cal Points	: 100.0 %, 0.0 %
Span. Coef	: 1.23
Zero. Coef	: 0.12
Cal Temp.	: 25.0 C (ATC)
Electrode Status	: Excellent
User Name	:
Signature	:



DO (mg/L)

Meter Model	: OAKTON PD260
Serial Number	: 123456789
SW Revision	: 1.00
Date	: 20 Aug 2018
Time	: 10:10:28
Cal Points	: 8.26 mg/L, 0.0 mg/L
Span. Coef	: 1.23
Zero. Coef	: 0.12
Cal Temp.	: 25.0 C (ATC)
Electrode Status	: Excellent
User Name	:
Signature	:



Specifications

• **Appendix 3**

Model	PD250	PD260
	pH/ORP/DO/Temp (°C/°F)	
pH Range	-2.00 to 16.00 pH	
Resolution	0.01 pH	
Accuracy	±0.01 pH	
Calibration Points	USA & NIST (Up to 5), DIN (Up to 6)	
pH Buffer Groups	USA, NIST, DIN	
ORP Range	±2000 mV	
Resolution	0.1 mV (< ±1000 mV), 1 mV (≥ ±1000mV)	
Accuracy	±0.3 mV (< ±1000 mV) or 0.3% of reading (≥ ±1000mV)	
Calibration Option	Yes	
Dissolved Oxygen (DO) Range	0.0 to 20.00 mg/L 0.0 to 200.0%	
Resolution	0.01 mg/L, 0.1%	
Accuracy	±0.1 mg/L	
Salinity Compensation	0.0 to 40.0 ppt	
Barometric Pressure Compensation	Yes	
DO Probe Type	Galvanic integrated with temperature sensor	
Calibration Points	Up to 2	
Temperature Range	-30.0 to 130.0 °C / -22.0 to 266.0 °F	
Resolution	0.1 °C / °F	
Accuracy	± 0.5 °C / ± 0.9 °F	
Calibration Option	Yes	
Memory	500	1000
Auto Data Log	●	●
Real-time Clock	-	●
Date & Time Stamp	-	●
Auto Hold / Auto Stable / Real Time	●	●
Offset & Average Slope Display	●	●
Calibration Alarm (1 to 90 days)	●	●
Auto Shut-Off (1 to 30 mins.)	●	●
Electrode Status	●	●
Diagnostic Messages	●	●
Software Upgrade ^{*1}	●	●

Specifications

PC Communication *1	-	●
Printer Communication *2	-	●
Meter Inputs	BNC, phono	
Display	Custom LCD with backlight	
Housing	IP67, shock & scratch resistant, non-slip	
Power Requirement	2 × AA batteries	
Battery Life	> 500 hours	
Dimensions	160 (L) × 80 (W) × 40.60 (H) mm	
Weight	Approx. 260 g (with batteries) / 216 g (without batteries)	

*1 Via PC (USB) cable

*2 Via Printer (RS232) cable

