



**TMD-55 / TMD-55W**  
Multilogger Thermometer  
/ Wireless Download

**TMD-56**  
Multilogger Thermometer  
with USB Download

**Users Manual**

- Mode d'emploi
- Bedienungshandbuch
- Manual d'Usò
- Manual de uso



**TMD-55 / TMD-55W**  
Multilogger Thermometer  
/ Wireless Download

**TMD-56**  
Multilogger Thermometer  
with USB Download

English

## **Users Manual**

June 2010, Rev.1  
©2010 Amprobe Test Tools.  
All rights reserved. Printed in Taiwan

**TMD-55 / TMD-55W / TMD-56**

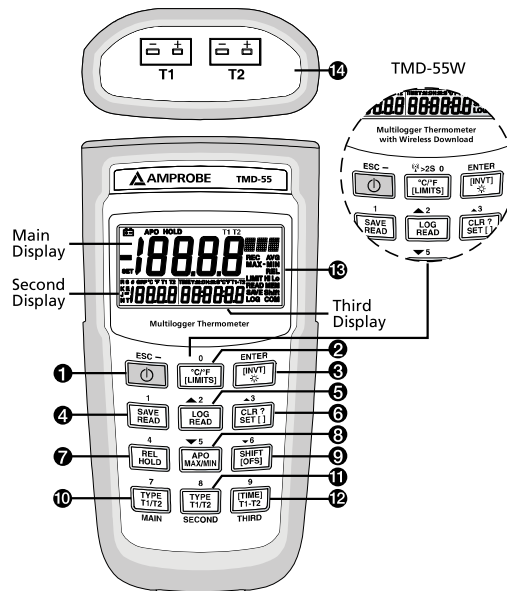

- |                             |                           |
|-----------------------------|---------------------------|
| 1) "⏻" Power Button         | 8) "APO/MAX/MIN" Button   |
| 2) "°C /°F/[LIMITS]" Button | 9) "SHIFT/[OFS]" Button   |
| 3) "[INVT]/[LIMITS]" Button | 10) "TYPE/T1/T2" Button   |
| 4) "SAVE/READ" Button       | 11) "TYPE/T1/T2" Button   |
| 5) "LOG/READ" Button        | 12) "[TIME]/T1-T2" Button |
| 6) "CLR ?/SET [ ]" Button   | 13) LCD Display           |
| 7) "REL/HOLD" Mode          | 14) T1/T2 Input           |

## Screen Display

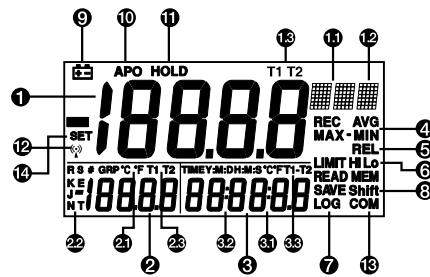

- |                               |                                  |
|-------------------------------|----------------------------------|
| 1) Main display               | 4) MAX/MIN reading               |
| 1.1) Degrees °C / °F          | 5) Relative mode                 |
| 1.2) Type of T/C thermocouple | 6) Hi/Lo Limits comparative mode |
| 1.3) T1 or T2 temperature     | 7) Data SAVE/LOG and READ mode   |
| 2) Second display             | 8) Shift mode                    |
| 2.1) Degrees °C / °F          | 9) Low BATT display              |
| 2.2) Type of T/C thermocouple | 10) Auto power off               |
| 2.3) T1 or T2 temperature     | 11) Main display DataHOLD mode   |
| 3) Third display              | 12) Wireless Mode (TMD-55W)      |
| 3.1) Degrees °C / °F          | 13) Commutation mode             |
| 3.2) Time or Date display     | 14) SET mode                     |
| 3.3) T1-T2 differential       |                                  |

---





## CONTENTS

SYMBOLS .....	3
UNPACKING AND INSPECTION .....	5
INTRODUCTION .....	5
Features .....	5
OPERATION INSTRUCTIONS .....	7
Operational Mode .....	7
Normal Mode .....	7
Shift Mode .....	7
Setup Mode .....	8
Wireless Mode (For TMD-55W) .....	8
To check the channel and ID of the mete .....	8
Normal Mode .....	8
“  <p>1</p>	

---

"SAVE" Button.....	12
"LOG" Button.....	12
"CLR ?" Button.....	13
"REL" Button.....	13
"APO" Button.....	13
"TYPE" Button (Main display).....	13
"TYPE" Button (Second display).....	14
Setup Mode.....	14
"[LIMITS]" Button.....	14
"[INVT]" Button.....	14
"APO" Button.....	15
"[OFS]" Button.....	15
"[TIME]" Button.....	15
Error messages.....	15
<b>SPECIFICATION</b> .....	<b>16</b>
<b>MAINTENANCE</b> .....	<b>19</b>

## SYMBOLS

	Caution! Refer to the explanation in this Manual
	Complies with European Directives
	Tested Comply With FCC Standards
	Do not dispose of this product as unsorted municipal waste.

### **⚠ WARNING and PRECAUTIONS**

- *To avoid electrical shock, do not use this instrument when working voltages at the measurement surface over 24V AC or DC.*
- *To avoid damage or burns, do not make temperature measurement in microwave ovens.*
- *Repeated sharp flexing can break the thermocouple leads. To prolong lead life, avoid sharp bends in the leads, especially near the connector.*

### **Federal Communications Commission**

The devices TMD-55W are complied with Part 15 of the FCC Rules.

Operation is subject to the following two conditions:  
(1) this device may not cause harmful interference,  
and (2) this device must accept any interference received, including interference that may cause undesired operation.

### **Note**

The equipments TMD-55W have been tested and found to comply with the limits for a Class B digital device, pursuant to Part 15 of the FCC Rules. These limits are designed to provide reasonable protection. This equipment generates, uses and can radiated radio frequency energy and, if not installed

and used in accordance with the instructions, may cause harmful interference to radio communications. However, there is no guarantee that interference will not occur in a particular installation if this equipment does cause harmful interference to radio or television reception, which can be determined by turning the equipment off and on, the user is encouraged to try to correct the interference by one or more of the following measures:

- Reorient or relocate the receiving antenna.- Increase the separation between the equipment and receiver.
- Connect the equipment into an outlet on a circuit different from that to which the receiver is connected.
- Consult the dealer or an experienced radio/TV technician for help.

Shielded interface cables must be used in order to comply with emission limits.

Changes or modifications not expressly approved by the party responsible for compliance could void the user's authority to operate the equipment.

**Wireless Note**

Wireless receiver must keep a distance at least 40cm from the meter and meter to meter distance must be at least 30cm.



## UNPACKING AND INSPECTION

---

Your shipping carton should include:

- 1 Meter
- 1 Manual
- 1 USB Cable (TMD-56)
- 1 Software CD ROM (TMD-56 / TMD-55W)
- 4 AAA Batteries
- 2 K type Thermocouple
- 1 Plain white box

If any of the items are damaged or missing, return the complete package to the place of purchase for an exchange.

## INTRODUCTION

---

The instrument is a portable digital thermometer that measures external thermocouples of type K, J, R, S, T, E, N. The thermocouples types comply with the N.I.S.T. – ITS 90 standard reference temperature/voltage tables. The thermometer features a dual thermocouple input and an adjustable T/C offset.

### Features

#### TMD-55 and TMD-55W

- Wireless two ways transmission. (TMD-55W only)
- Dual input function.
- Basic accuracy: 0.05%
- **2 Channel Temperature Measuring:**  
T1, T2 for various thermocouples.
- **Triple displays with set-able backlight:**  
MAIN display for T1, T2.  
SECOND display for T1, T2.

THIRD display for T1- T2, TIME.

DATA LOGGER function

- **Data logger capacity:**  
**Save data:** 128 samples with read-time data.  
**Data logger:** 16 sets, Maximum 1024 data capacity.  
Easy Reads Data with down and up key on meter.
- T/C Offset Adjust.
- REC, MAX, MIN, MAX-MIN, AVG, REL, HOLD functions.
- T1, T2, T1-T2, Time and Memory No.
- Resolution 0.1°C/1°C, 0.1°F/1°F.
- Warning beeper with Hi/Lo setting.
- TIME, Record interval, APO time setting.
- Real time clock with calendar.
- Selectable Auto Power Off function.

**TMD-56**

- USB Port provides excellent user interface.
- DC 12V adapter.
- Basic accuracy: 0.05%.
- Dual inputs with K/J/E/T/R/S/N thermocouple.
- Triple display with settable backlight.
- Real time clock and calendar.
- **Data logger capacity:**  
**Save data:** 256 samples with real time data.  
**Data logger:** 16 sets, Max 16000 data capacity.  
Easy read data with uP/down keys.
- Selectable Auto Power Off function.
- Warning beeper with Hi/Lo setting.

- MAX/MIN/AVG/REL/HOLD function.
- MAIN display for T1/T2.
- SECOND display for T1/T2.
- THIRD display for T1-T2, with real time clock and calendar.

**Model Difference:**

Model	Memories	Wireless	USB	DC IN
TMD-55	Save 128, Log 1024	X	X	X
TMD-56	Save 256, Log 16000	X	V	V
TMD-55W	Save 128, Log 1024	V	X	X

**OPERATING INSTRUCTIONS**

**Operational Mode**

There are three operation modes-Normal, Shift, and Setup Mode.

**Normal Mode**

This is the default mode, the operating functions for the normal mode are printed on the top of each button in white.

**Shift Mode**

The operating functions for the shift mode are printed in white on the buttons. While in the normal mode, press the "SHIFT" button to switch to shift mode. At the lower-right corner of the display, the word "Shift" is displayed to indicate shift mode. To switch back to normal mode, press the "SHIFT" button again.

#### **Setup Mode**

Press the "SET[ ]" button in normal mode to switch to setup mode, the indicator "SET" is shown on the left side of the display. To switch back to normal mode, press "SET[ ]" button.

#### **Wireless Mode**

Press the "☺" key for more than two seconds to start wireless function. Press the "☺" key again for another two seconds to stop wireless function. The wireless mode will shut down if there is no wireless signal for two minutes.

To SET CH/ID to 00,00, by pressing "T1-T2" key and "⏻" power key for more than 6 seconds with the meter powered down. The meter will set channel and ID to 00,00 status. The second display will show 00, which means that the channel and ID has been set to 00.

#### **To check the channel and ID of the meter**

When the meter is off press "<sup>C/F</sup>[LIMITS]" key and "⏻" for 5 seconds, LCD's main display will show channel number, the second display will show ID number.

#### **Normal Mode**

The following functions can only be used in the normal mode.

#### **"⏻" Power Button**

The "⏻" key turns the thermometer on or off. When enter data REC mode, the power off function is disabled.

#### **"[LIMITS]" Button (only Main display)**

The limits function will alert the user when a measurement exceeds a specified limit. To set the limit values, refer to limits function in the setup mode. Press the "[LIMITS]" button to activate the limits function; the word "LIMIT" should be displayed on the LCD.

When the value of the main display exceeds the Hi limit, the word "Hi" will be displayed and the thermometer will beep in a pulsed tone. If the value of the main display is lower than the Lo limit, the word "Lo" will be displayed and the thermometer will beep in a continuous tone. To exit the limits function, press the "[LIMITS]" button.

**"☀" Button**

The backlight function is represented by this button "☀". Pressing the button will turn on or off the LCD backlight. The backlight will turn off automatically after.

**"SAVE/READ" Button**

The read data function works in conjunction with the save function in the shift mode, it is used for reading saved data. The save function can be activated in shift mode. Press the "SAVE/READ" button to read saved data; the word "READ" should be displayed on the LCD. To navigate around the save data table, press the overlay "SECOND" button until the "#" sign is displayed on the second display. The location of the read pointer within the saved data table will be displayed. The arrow buttons on the overlay are used for scrolling through the saved data. Press the smaller arrows "▲" or "▼" to step through the data one at a time. Press the larger arrows "▲" or "▼" to step through the data ten at a time. Pressing the overlay "ESC" button deactivates the read data function.

**"LOG/READ" Button**

The read log function works in conjunction with the log function. It is used for reading logged data. The log function can be activated in the shift mode. Press the "LOG/READ" button to activate the log read function; the word "READ" is displayed on the LCD. Press the overlay "SECOND" button to rotate through following display menus: T1, T2, GRP, and #. T1 and T2: Displays the T1 or T2 saved data. GRP: Displays the current group number. #:

Displays the current location of the read pointer within a selected group. The arrow buttons on the overlay are used for scrolling through the data and groups. Press the smaller arrows "▲" or "▼" to step through the logged data or groups one at a time. Press the larger arrows "▲" or "▼" to step through the data or groups ten at a time. To navigate the logged data and groups, press the overlay "SECOND" button until GRP appears in the second display panel. Then select the group using the arrows. Press the "SECOND" button again until the "#" sign is displayed. The location of the read pointer in the selected group will be displayed. Use the arrows to scroll through the data. Pressing the overlay "ESC" button deactivates the read data function.

**"HOLD Mode" (only Main display)**

When HOLD mode is selected, the thermometer holds the present readings and stops all further measurements. To activate the data hold mode, press the "HOLD" key, and "HOLD" is displayed on the LCD. Pressing the "HOLD" key again cancels the function, and the instrument will automatically resume measurements.

**"MAX/MIN" with Time record mode (only Main display)**

The "MAX/MIN" function records the highest and lowest value recorded, and it calculates the average reading, and the differences of MAX to MIN. Press "MAX/MIN" key to enter the MAX/MIN recording mode. The beeper emits a tone when a new minimum or maximum measurement is recorded. Press the "MAX/MIN" key again to rotate through the current readings: **MAX**: The highest measurement recorded. **MIN**: The lowest measurement recorded. **MAX-MIN**: The difference of the highest and the lowest measurement. **AVG**: The average values of the measurements.

This mode works in conjunction with the hold function, pressing the "HOLD" key will stop the recording and measurements (Previously recorded readings are not

erased). Press "HOLD" key again to resume recording and measurements. To prevent accidental loss of MIN, MAX and AVG data, the MAX/MIN function can only be cancelled by pressing and holding down the "MAX/MIN" key for more than 2 seconds. The automatic power-off feature, and the power, "°C/°F", "REL", "SET", "Hi/Lo LIMITS", "TYPE", "T1/T2" keys are also disabled.

**"T1/T2" Button (Main display)**

The input selection button "T1/T2" selects the input for the main display, T1 thermocouple or T2 thermocouple. Press the "T1/T2" button to switch between the two inputs. When meter is turned on, it is set to the display that was last in use.

**"T1/T2" Button (Second display)**

The input selection button "T1/T2" selects the input for the second display, T1 thermocouple or T2 thermocouple. Press the "T1/T2" button to switch between the two inputs. When meter is turned on, it is set to the display that was last in use.

**"[TIME]/T1-T2" Button (Third display)**

The input selection button "T1-T2" selects the system time and date, or the differential between the two thermocouples (T1-T2) for the third display. Press the "T1-T2" button to switch the display options. When meter is turned on, it is set to the display that was last in use.

**Shift Mode**

The following functions can only be used in the shift mode.

**"°C/°F" Button**

Press the "°C/°F" key to select the temperature scale, readings can be displayed in Celsius (°C) or Fahrenheit (°F). When the thermometer is turned on, it is set to the temperature scale that was last in use.

**“SAVE” Button (TMD-56 except)**

The save function stores the T1, T2 data in a nonvolatile memory. Press the “SAVE” button to save the current data, the word SAVE is displayed to indicate the data has been saved. The built in memory can store up to 128 data. The data can be read using the read function in the normal mode.

**“SAVE” Button (TMD-56)**

The save function stores the T1, T2 data in a nonvolatile memory. Press the “SAVE” button to save the current data, the word SAVE is displayed to indicate the data has been saved. The built in memory can store up to 256 data. The data can be read using the read function in the normal mode.

**“LOG” Button (TMD-56 except)**

The data log function continuously records the data according to a specified time interval. The time interval can be set using the interval setup function [INVT] in the set up mode. Press the “LOG” button to activate the log function; the indicators “LOG” and “MEM” will be displayed on the LCD. There are 16 groups that are used for storing the log data, and each group uses 64 data slots. If the current log session exceeds 64 data points, the log function will automatically use the next group to store the following data. A maximum of 1024 data points can be saved in one log session. Press the “LOG” button again to exit the data log function.

**“LOG” Button (TMD-56)**

The data log function continuously records the data according to a specified timeinterval. The time interval can be set using the interval space setup function [INVT] in the set up mode. Press the “LOG” button to activate the log space function; the indicators “LOG” and “MEM” will be displayed on the LCD. There are 16 groups that are used for storing the log data. A maximum of 16,000 data



point can be saved in one log session. Press the "LOG" button again to exit the data log function.

**"CLR ?" Button**

The CLR function clears all the saved and logged data in memory. When the "CLR" button is pressed, indicator "MEM" is displayed and the "CLR" on upper-right of LCD will blink. Pressing the "ENTER" button printed on the overlay in white will clear all saved and logged data. Press "ESC" button to exit this function without clearing data.

**"REL" Button (Main display)**

The relative value function can be used for comparing the saved reference value with other measurements. Press the "REL" button to store the current measurement as the reference value, and "REL" should be displayed on the right part of the LCD. The next measurement will display the current value compared to the reference value. Press "REL" button again to clear the reference value and deactivate the relative value measurement function.

**"APO" Button**

Press the "APO" button to turn the "Auto power off" function on or off. When this function is enabled, the indicator "APO" is shown at the upper left part of the LCD. When APO (Auto power off) is enabled, it will automatically turn the thermometer off no button is pressed for a period longer than the set time interval (the default time for APO is 5 minutes). Press power button to resume operation.

**"TYPE" Button (Main display)**

Press this key to change the type of thermocouple in the main display (K/J/T/E/R/S/N). If the inputs of the main and second display are the same, then pressing this key will change the thermocouple type for both displays.

**“TYPE” Button (Second display)**

Press this key to change the type of thermocouple in the second display (K/J/T/E/R/S/N). If the inputs of the main and second display are the same, then pressing this key will change the thermocouple type for both displays.

**Setup Mode**

The following functions can only be use in the setup mode.

**“[LIMITS]” Button (Hi/Lo limit setting)**

Press the “LIMITS” button to enter the Hi/Lo limit setup function. The words “LIMIT” and “Hi” will be flash on the LCD along with the previous value for the Hi limit. Enter the new Hi limit value using the number keys printed in white on the overlay. The resolution of Hi/Lo limit setup is 1 count. The “-” button (same button as the ESC) can be used to enter negative values. Press the “ENTER” button to confirm the new limit. You will then be prompted to enter a new Lo limit value. Enter the new value and then press enter to finish setup of limits.

**“[INVT]” Button (Interval time setting)**

To setup the time interval for the log function, press the “[INVT]” button. The indicator “INV” will blink on the top-right of the LCD and the previous interval is displayed. Press the number buttons printed in white on the overlay to change the time interval. Setting is from left to right of the following format (HH:MM:SS). Press the overlay “ENTER” button to confirm. To exit this function, press the ESC button.

HH: interval Hour (0~23)

MM: interval Minute (0~59)

SS: interval Second (0~59)

MAX: 23:59:59

MIN: 00:00:01

**“APO” Button (Auto power off time setting, min. 1 minute)**

Use this function to change the time for the auto power off (APO) function. Press the “APO” button in setup mode, and the indicator “APO” and the current time will flash on the LCD. The default time for APO is 5 minutes. Press the number button printed in white on the overlay to set the APO time. Press the overlay “ENTER” button to confirm. To exit this function without changing the setting, press the “ESC” button.

**MAX:** 19999 minutes

**MIN:** 0001 minutes

**“[OFS]” Button (Thermocouple offset adjust)**

When the main display input is T1 and a thermocouple is connected, the instrument can adjust the offset of the thermocouple. The same can be done for T2 when on the main display. In the setup mode, press this button to enter the thermocouple Offset Setup Function (OFS) and the indicator CAL should be displayed on the top-right of the LCD and the current setting is also shown. Press the number buttons printed in white on the overlay to change the offset of the thermocouple. The resolution of the setup is 0.1°. Press the “-” button to set a negative value. Press the overlay “ENTER” button to confirm. MAX: ±1999.9 °C/°F.

**“[TIME]” Button (System time setting)**

To set the system time, press the “[TIME]” button in the setup mode. The third display should show the current date and time with the year flashing. Enter the new value from left to right in the following format YY:MM:DD and HH:MM:SS. Press the number buttons printed in white on the overlay to set the system date and time. Press the “ENTER” button to confirm. Exit this function by pressing “ESC” button.

**Error messages**

When the meter appears wrong messages such as Err-01, Err-02 and Err-03.

**Err-01:** In the "SAVE" mode, if memory is full, the lower right display will show Err-01. If you would like to record the new value. Please clear all old records.

**Err-02:** In the "LOG" mode, if memory is full, the lower right display will show Err-02. If you would like to record the new value. Please clear all old records.

**Err-03:** In the "READ LOG" and "READ SAVE" mode, when the main display shows 6208 and the lower right display shows "OL, Err-03". Which means that there might appear two situations:  
1. There is no data in the memory.  
2. The memory is full, and the meter will warn the user this is the last sample.

## SPECIFICATION

---

### Electrical

**Temperature Scale:** Celsius or Fahrenheit user-selectable

**Measurement Range:**

Thermocouple Type	Range
K-TYPE (0.1°)	-200°C to 1372°C (-328°F to 2501°F)
J-TYPE (0.1°)	-210°C to 1200°C (-346°F to 2192°F)
T-TYPE (0.1°)	-200°C to 400°C (-328°F to 752°F)
E-TYPE (0.1°)	-210°C to 1000°C (-346°F to 1832°F)
R-TYPE (1°)	0°C to 1767°C (32°F to 3212°F)
S-TYPE (1°)	0°C to 1767°C ( 32°F to 3212°F)
N-TYPE (0.1°)	-50°C to 1300°C ( -58°F to 2372°F)

\*Based on the ITS-90 temperature standard.  
According to temperature standard ITS-90.

**Accuracy:**

<b>K/J/T/E-TYPE</b>	
±(0.05% rdg + 0.3°C)	-50°C to 1372°C
±(0.05% rdg + 0.7°C)	-50°C to -210°C
±(0.05% rdg + 0.6°F)	-58°F to 2501°F
±(0.05% rdg + 1.4°F)	-58°F to -346°F
<b>N-TYPE</b>	
±(0.05% rdg + 0.8°C)	-50°C to 0°C
±(0.05% rdg + 0.4°C)	0°C to 1300°C
±(0.05% rdg + 1.6°F)	-58°F to 32°F
±(0.05% rdg + 0.8°F)	32°F to 2372°F
<b>R/S-TYPE</b>	
±(0.05% rdg + 2°C)	0°C to 1767°C
±(0.05% rdg + 4°F)	32°F to 3212°F

<b>Temperature Coefficient</b>	0.1 times the applicable accuracy specification per °C from 0°C to 18°C and 28°C to 50°C (32°F to 64°F and 82°F to 122°F).
<b>Input Protection</b>	24V dc or 24V ac rms maximum input Voltage on any combination of input pins.

**Environmental**

<b>Ambient Operating Ranges</b>	0°C to 50°C (32°F to 122°F) <80% R.H.
<b>Storage Temperature</b>	-20°C to 60°C (-4°F to 140°F) <70% R.H.

### General

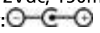
<b>Display</b>	Main, Second, Third: The Main and Second display panels are 4 ½ digit liquid crystal display (LCD) with maximum reading of 19999, these panels are used for is playing the value of T1 or T2. The Third panel displays the date, time, or the difference value of T1 to T2. When the input measurement is overloaded, the following is displayed "----_".
<b>Overload</b>	"----_" or "OL" is display..
<b>Battery</b>	4 X 1.5V AAA
<b>Battery Life</b>	120 hours typical with carbon zinc battery.
<b>External Power (TMD-56)</b>	DC IN: 12Vdc, 150mA (TMD-56) Polarity:  DC Jack Size: Inner diameter 1.35 +/- 0.1 mm Outer diameter 3.50 +/- 0.1 mm
* Not included in the packaging	
<b>Reading Rate</b>	2.5 time per second.
<b>Dimensions</b>	160 mm (H) x 83 mm (W) x 38 mm (D); 6.3 in (H) x 3.3 in (W) x 1.5 in (D).
<b>Weight</b>	Approx. 365g (0.8lb) including batteries.
<b>Supplied Wire</b>	4 feet type "K" thermocouple bead wire (Teflon tape insulated). Maximum insulation temperature 260°C (500°F). Wire accuracy ±2.2°C or ±0.75% of reading (whichever is greater) from 0°C to 800°C (32 °F to 1472°F).

Wire Communication Protocol	19200 baud rate. (TMD-56)
-----------------------------	---------------------------

 **Wireless Features**

Frequency range 910-920MHz (TMD-55W)  
 Low current consumption less than 1mA.  
 The transmitting distance can reach 25M without magnetic interference.

 **EMC: Conforms to EN61326-1.**

This product complies with requirements of the following European Community Directives: 89/ 336/ EEC (Electromagnetic Compatibility) and 73/ 23/ EEC (Low Voltage) as amended by 93/ 68/ EEC (CE Marking). However, electrical noise or intense electromagnetic fields in the vicinity of the equipment may disturb the measurement circuit. Measuring instruments will also respond to unwanted signals that may be present within the measurement circuit. Users should exercise care and take appropriate precautions to avoid misleading results when making measurements in the presence of electronic interference.

**MAINTENANCE AND REPAIR**

 **WARNING**

*To avoid possible electrical shock, disconnect the thermocouple connectors from the thermometer before removing the cover.*

**Installing and Replacing Battery**

- A. Screw
- B. Battery Cover
- C. Battery

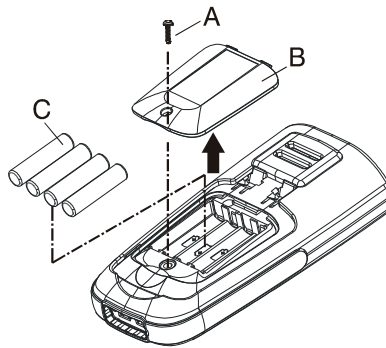

1. Power is supplied by 4pcs 1.5V (SIZE AAA) UM-4 R03.
2. The “” appears on the LCD display when replacement is needed. To replace battery remove screw from back of meter and lift off the battery cover.
3. Remove the batteries from the battery compartment and replace them with new ones.
4. When not use for long time, remove the battery.
5. Do not store the unit in place with temperature and humidity beyond the recommended storage temperature.

#### **Cleaning**

Periodically wipe the case with a damp cloth and detergent, do not use abrasives or solvents.