



# User Manual

## T3DSO1000 Series Digital Oscilloscope



---

# Copyright and Declaration

## Copyright

Teledyne LeCroy. All Rights Reserved.

## Trademark Information

**Teledyne Test Tools** is the registered trademark of **Teledyne LeCroy**.

## Declaration

**Teledyne Test Tools** products are protected by patent law.

**Teledyne Test Tools** reserves the right to modify or change parts of or all the specifications or pricing policies at company's sole decision.

Information in this publication replaces all previously corresponding material.

Any way of copying, extracting or translating the contents of this manual is not allowed without the permission of **Teledyne Test Tools**.

## Product Certification

**Teledyne Test Tools** guarantees this product conforms to national and industrial standards and other international standards.

## Contact Us

---

# Safety Information

## General Safety Summary

Carefully read the following safety precautions to avoid any personal injury or damage to the instrument and any products connected to it. To avoid potential hazards, please use the instrument as specified.

### Use Proper Power Line

Only the power cord designed for the instrument and country should be used.

### Ground the Instrument

The instrument is grounded through the protective earth conductor of the power line. To avoid electric shock, please make sure the instrument is grounded correctly before connecting its input or output terminals.

### Connect the Signal Ground Wire Correctly

The potential of the signal ground wire is equal to earth, so do not connect the signal ground wire to a high voltage.

### Look Over All Terminal Ratings

To avoid fire or electric shock, please look over all ratings and sign instructions of the instrument. Before connecting the instrument, please read the manual carefully to gain more information about the ratings.

### Use Proper Overvoltage Protection

Make sure that no overvoltage (such as that caused by a thunderstorm) can reach the product, or else the operator might be exposed to the danger of electrical shock.

### Electrostatic Prevention

Operate in an electrostatic discharge protective environment to avoid damage induced by static discharge. Always ground both the internal and external conductors of any cables to discharge static before connecting.

### Keep Ventilated

Inadequate ventilation may cause increasing product temperature, which will eventually damage the instrument. So keep well ventilated and inspect the intake and fan regularly.

### Avoid contact with Exposed Circuit or Components

Do not touch exposed contacts or components when the power is on.

---

### **Use proper Fuse**

Use only the specified fuse.

### **Do Not Operate Without Covers**

Do not operate the instrument with covers or panels removed.

### **Do Not Operate With Suspected Failures.**

If you suspect damage occurs to the instrument, have it inspected by qualified service personnel before further operations. Any maintenance, adjustment or replacement especially to circuits or accessories must be performed by **Teledyne Test Tools** authorized personnel.

### **Do Not Operate in Wet Conditions.**

In order to avoid short circuiting the interior of the device or electric shock, please do not operate in a high humidity environment.

### **Do Not Operate in an Explosive Atmosphere.**

In order to avoid damage to the device or personal injuries, it is important to operate the device away from an explosive atmosphere.

### **Keep Product Surfaces Clean and Dry.**

To avoid the influence of dust and/or moisture in the air, please keep the surface of the instrument clean and dry.

### **Handling Safety**

Please handle with care during transportation to avoid damages to buttons, knob interfaces and other parts on the panels.

Only probe assemblies which meet the manufacturer's specifications shall be used.

When using 2X/.../10000X probe assemblies, the probe assemblies shall be insulated from the measured circuits by double or reinforced insulation.

All probe assemblies should meet the requirements of UL 61010-031 and CAN/CSA-C22.2 No. 61010-031-07.

If the equipment is used in a manner not specified by the manufacturer, the protection provided by the equipment may be impaired.

---

## Safety Terms and Symbols

**Terms in this Manual.** These terms may appear in this manual:



---

### **WARNING**

Warning statements indicate the conditions or practices that could result in injury or loss of life.

---



---

### **CAUTION**

Caution statements indicate the conditions or practices that could result in damage to this product or other property.

---

**Terms on the product.** These terms may appear on the product:

**DANGER** Indicates direct injuries or hazards that may happen.

**WARNING** Indicates potential injuries or hazards that may happen.

**CAUTION** Indicates potential damage to the instrument or other property that may happen.

**Symbols on the product.** These symbols may appear on the product:



**Hazardous  
Voltage**



**protective Earth  
Terminal**



**Warning**



**Test  
Ground**



**Power Switch**

If find such symbols appear on the product, consult the manual to find out the nature of the potential hazard and the actions which have to be taken.

---

## Measurement Category

### Measurement Categories

This oscilloscope can make measurements in circuits that are not directly connected to mains.



---

#### **WARNING**

This oscilloscope can only be used for measurements within its specified measurement categories.

Do not use the product for measurements within other measurement categories, such as CAT II, CAT III, CAT IV.

Do not use the equipment for measurements on mains circuits

---

### Measurement Category Definitions

Measurement category II is for measurements performed on circuits directly connected to the low voltage installation. Examples are measurements on household appliances, portable tools and similar equipment.

Measurement category III is for measurements performed in the building installation. Examples are measurements on distribution boards, circuit-breakers, wiring, including cables, bus-bars, junction boxes, switches, socket-outlets in the fixed installation, and equipment for industrial use and some other equipment, for example. Stationary motors with permanent connection to the fixed installation.

Measurement category IV is for measurements performed at the source of the low-voltage installation. Examples are electricity meters and measurements on primary over current protection devices and ripple control units.

---

## Working Environment

### Temperature

Operating: 10°C to +40°C

Non-operation:-20°C to +70°C

### Humidity

Under +35°C:≤90% relative humidity

+35°C to +40°C: ≤60% relative humidity



### WARNING

To avoid short circuit inside the instrument or electric shock, please do not operate in humid environment.

---

### Altitude

Operating: less than 3 Km

Non-operation: less than 15 Km

### Degree of protection

IP20

### Installation (over voltage) Category

This product is powered by mains conforming to installation (overvoltage) category II.



### WARNING

Make sure that no over voltage (such as that caused by thunderbolt) can reach the product, or else the operator might expose to the danger of electric shock.

---

### Installation (over voltage) Category Definitions

Installation (over voltage) category I refers to signal level which is applicable to equipment measurement terminals connected to the source circuit. In these terminals, precautions are done to limit the transient voltage to the corresponding low level.

Installation (over voltage) category II refers to the local power distribution level which is applicable to equipment connected to the AC line (AC power).

---

## Ventilation Requirement

This oscilloscope uses a fan for cooling. Please make sure that the air intake and exhaust areas are free from obstructions and have free air. When using the oscilloscope in a bench-top or rack setting, provide at least 10 cm clearance beside, above and behind the instrument for adequate ventilation.



---

### **WARNING**

Inadequate ventilation may cause temperature increase which would damage the instrument. So please keep the instrument well ventilated during operation and inspect the intake and fan regularly.

---



---

## General Care and Cleaning

### Care

Do not store or leave the instrument in direct sunshine for long periods of time.



#### **WARNING**

To avoid damage to the instrument or probe, please do not leave them in fog, liquid, or solvent.

---

### Cleaning

Please perform the following steps to clean the instrument and probe regularly according to its operating conditions.

1. Disconnect the instrument from all power sources, and then clean it with a soft wet cloth.
2. Clean the loose dust on the outside of the instrument and probe with a soft cloth. When cleaning the LCD, take care to avoid scarifying it.



#### **WARNING**

To avoid damage to the surface of the instrument and probe, please do not use any corrosive liquid or chemical cleanser.

---



#### **WARNING**

Make sure that the instrument is completely dry before restarting it to avoid short circuits or personal injuries.

---

---

# Document Overview

This manual describes how to use the digital oscilloscope in detail.

<b>Quick Start</b>	Provide information about preparation before using the instrument and a brief introduction to the instrument.
<b>Set the Vertical System</b>	Introduce the functions of the vertical system of the oscilloscope.
<b>Set the Horizontal System</b>	Introduce the functions of the horizontal system of the oscilloscope.
<b>Set the Sampling System</b>	Introduce the functions of the sampling system of the oscilloscope.
<b>Trigger the Oscilloscope</b>	Introduce the trigger mode, trigger coupling, trigger hold off, external trigger and various trigger types of the oscilloscope.
<b>Serial Trigger</b>	Introduce how to trigger on serial input signals.
<b>Save Reference Waveforms</b>	Introduce how to save and display REF waveforms.
<b>How To Make Math Operations</b>	Introduce the math operation function of the oscilloscope.
<b>How To Make Cursor Measurements</b>	Introduce how to use cursors to make measurements.
<b>How To Use Measurement Functions</b>	Introduce how to use the measurement function to measure the waveform parameters.
<b>Display Settings</b>	Introduce how to set up the oscilloscope display.
<b>Save and Recall</b>	Introduce how to save and recall the measurement result and the settings of the oscilloscope.
<b>System Settings</b>	Introduce how to adjust the system setup.
<b>Default</b>	Introduce the Default setup of the oscilloscope
<b>Troubleshooting</b>	Introduce how to deal with common failures of the oscilloscope.

---

## Table of Content

Copyright and Declaration .....	I
Safety Information .....	II
General Safety Summary.....	II
Safety Terms and Symbols.....	IV
Measurement Category .....	V
Working Environment .....	VI
Ventilation Requirement.....	VII
General Care and Cleaning.....	VIII
Document Overview.....	IX
Quick Start.....	1
General Inspection .....	2
Appearance and Dimensions .....	3
To Prepare the Oscilloscope for Use .....	5
To Adjust the Supporting Legs.....	5
To Connect to Power Supply .....	6
Power-on Inspection .....	7
To Connect the Probe .....	7
Function Inspection .....	8
Probe Compensation .....	9
Front Panel Overview .....	10
Rear Panel Overview.....	12
Front Panel Function Overview.....	14
Horizontal.....	14
Vertical .....	15
Trigger .....	16
Run Control .....	17
Universal Knob.....	18
Menu.....	19
Help.....	21
User Interface.....	22
To Use the Security Lock .....	24
To Set the Vertical System .....	25
To Enable the Channel.....	26
To Adjust the Vertical Scale .....	27
To Adjust the Vertical Position .....	27
To Specify Channel Coupling .....	28
To Specify Bandwidth Limit .....	28
To Specify Probe Attenuation Factor.....	29
To Specify channel Input Impedance .....	29
To Specify Amplitude Unit.....	30
To Specify Deskew.....	30
To Invert a Waveform.....	30

---

Set the Horizontal System .....	31
Adjust the Horizontal Scale .....	32
Adjust Trigger Delay .....	33
Set the Roll mode .....	34
Use the Zoom Function .....	35
To Set the Sample System .....	36
Run Control .....	37
Overview of Sampling .....	38
Sampling Theory.....	38
Sample Rate.....	39
Oscilloscope Bandwidth and Sample Rate .....	40
Select Memory Depth .....	41
Select Sampling Mode.....	42
Select Waveform Interpolation Method .....	43
Select Acquisition Mode .....	45
Normal .....	45
Peak Detect .....	46
Average.....	47
High Resolution .....	48
Change the Horizontal Format .....	49
Use Sequence Mode .....	50
To Trigger the Oscilloscope .....	52
Trigger Source .....	54
Trigger Mode .....	55
Trigger Level .....	56
Trigger Coupling .....	57
Trigger Holdoff .....	58
Noise Rejection .....	59
Trigger Type.....	61
Edge Trigger.....	62
Slope Trigger.....	63
Pulse Trigger .....	65
Video Trigger .....	67
Window Trigger.....	70
Interval Trigger .....	73
DropOut Trigger.....	75
Runt Trigger.....	77
Pattern Trigger .....	79
Serial trigger and decode .....	81
I2C Trigger and Serial Decode .....	82
Setup for I2C Signals.....	82
I2C Triggering.....	84
I2C Serial Decode .....	88
SPI Triggering and Serial Decode.....	90

---

---

Setup for SPI Signals.....	90
SPI Triggering .....	93
SPI Serial Decode .....	95
UART/RS232 Triggering and Serial Decode .....	97
Setup for UART/RS232 Signals .....	97
UART/RS232 Triggering.....	99
UART/RS232 Serial Decode .....	101
CAN Trigger and Serial Decode .....	103
Setup for CAN Signals.....	103
CAN Triggering.....	105
CAN Serial Decode.....	107
LIN Triggering and Serial Decode .....	109
Setup for LIN Signals.....	109
LIN Triggering .....	110
LIN Serial Decode .....	112
To Save Reference Waveform.....	114
To Save REF Waveform to Internal Memory .....	115
To Display REF Waveform .....	115
To Adjust REF Waveform Display.....	116
To Clear REF Waveform Display.....	117
To Make Math Operation.....	118
Units for Math Waveforms.....	118
Math Operators.....	119
Addition or Subtraction.....	119
Multiplication and Division .....	120
FFT Operation.....	121
Math Function Operation.....	124
Differentiate .....	124
Integrate.....	125
Square Root.....	126
To Make Cursors Measurements .....	128
X Cursors .....	128
Y Cursors.....	128
To Make Cursor Measurements .....	129
To Make Measurements.....	130
Type of Measurement.....	131
Voltage Measurements .....	131
Time Measurements .....	133
Delay Measurements .....	134
To Make Automatic Measurement.....	135
To Clear Measurement Parameters.....	137
To Make All Measurement .....	137
Display Setting.....	138
To Set Display Type.....	139

---

---

To Set Color Display.....	140
To Set and Clear Persistence .....	140
To clear the display.....	141
To Select Grid Type.....	142
To Adjust Waveform Intensity.....	142
To Adjust Grid Brightness .....	143
To Adjust Transparence .....	143
Save and Recall.....	144
Save Type.....	145
Internal Save and Recall .....	147
External save and recall.....	148
Disk Management .....	151
To Create a New File or Folder.....	152
To delete a file or folder .....	153
Digital Channels(Optional) .....	154
To Connect the Digital Probes to the Device-under-test.....	155
Acquiring Waveform Using the Digital Channels.....	156
To Change the Display Type of the Digital Channels .....	156
To Switch a Single Channel On or Off.....	157
To Switch All Digital Channels On or Off.....	157
To Change the Logic Threshold for Digital Channels .....	158
To Reposition a Digital Channel.....	158
To Display Digital Channels as a Bus.....	159
System Function Setting.....	160
To View the System Status .....	161
To Do Self Calibration .....	162
To Enable or Disable the Sound .....	163
To Specify the Language.....	163
To Do Pass/Fail Test .....	164
To Set and Perform Pass/Fail Test.....	165
To Save and Recall Test Mask .....	166
Arbitrary Waveform Generator(Optional) .....	168
Output .....	169
Wave.....	169
Setting .....	171
Systems .....	173
Remove Device.....	174
IO Set.....	175
To Set the USB Device .....	175
To Set the LAN .....	176
To Set the WLAN (Option) .....	177
To Set Aux Output .....	178
To Use the Web Server.....	179
To Update Firmware and Configuration.....	180

---

---

Do Self Test .....	181
Screen Test .....	181
Keyboard Test .....	182
LED Test .....	183
To specify Screen Saver Time .....	184
To Use the Expand Setting.....	185
To Use the Power On Line .....	185
Option Management.....	186
Search.....	188
Setting .....	188
Results .....	189
Navigate .....	191
Time navigate.....	191
History frame navigate .....	191
Search event navigate .....	191
Bode Plot.....	193
Perform Bode Plot application .....	193
Setting .....	193
To Use the History Function.....	196
Factory Setup .....	198
Troubleshooting .....	202

---

## Content of Figure

Figure 1 Front View (2-channel scope) .....	3
Figure 2 Top View (2-channel scope) .....	3
Figure 3 Front View (4-channel scope) .....	4
Figure 4 Top View (4-channel scope).....	4
Figure 5 Adjust the Supporting Legs .....	5
Figure 6 To Connect to Power Supply .....	6
Figure 7 Function Inspection.....	8
Figure 8 2-channel Scope Front Panel Overview.....	10
Figure 9 4-channel Scope Front Panel Overview.....	11
Figure 10 2-channel Scope Rear panel Overview.....	12
Figure 11 4-channel Scope Rear panel Overview.....	13
Figure 12 Help Message .....	21
Figure 13 User Interface.....	22
Figure 14 To Use the Security Lock .....	24
Figure 15 Display Type Set to Dots.....	43
Figure 16 x Interpolation.....	44
Figure 17 Sinx/x Interpolation.....	44
Figure 18 Acquisition System .....	45
Figure 19 Pulse With 0.1% Duty, Normal Mode .....	46
Figure 20 Pulse With 0.1% Duty, Peak Detect Mode .....	46
Figure 21 With Random Noise, Normal Mode.....	47
Figure 22 With Random Noise, Average Mode.....	48
Figure 23 SEQUENCE Function Menu .....	50
Figure 24 HISTORY Function Menu .....	50
Figure 25 Turn off the Noise Reject.....	59
Figure 26 Turn on the Noise Reject.....	60
Figure 27 Edge Trigger.....	62
Figure 28 Slope Trigger.....	64
Figure 29 Pulse Trigger.....	66
Figure 30 Video Trigger .....	69
Figure 31 Absolute Window Trigger.....	71
Figure 32 Relative Window Trigger.....	72
Figure 33 Interval Trigger.....	74
Figure 34 Edge DropOut Trigger.....	76
Figure 35 State DropOut Trigger .....	77
Figure 36 Runt Trigger.....	78
Figure 37 Pattern Trigger.....	80
Figure 38 I2C DECODE Menu .....	82
Figure 39 I2C SIGNAL Menu.....	82
Figure 40 I2C Trigger Menu .....	87
Figure 41 I2C DECODE Menu .....	88



---

Figure 42 SPI SIGNAL Menu .....	91
Figure 43 SPI CLOCK Menu .....	91
Figure 44 MISO Menu .....	91
Figure 45 MOSI Menu .....	91
Figure 46 SPI TRIG SET Menu .....	93
Figure 47 UART SIGNAL Menu .....	97
Figure 48 UART / RS232 Bus Config Menu.....	98
Figure 49 UART TRIG SET Menu.....	99
Figure 50 UART Trigger.....	100
Figure 51 UART / RS232 Decode.....	101
Figure 52 CAN SIGNAL Menu.....	103
Figure 53 CAN Trigger.....	106
Figure 54 LIN SIGNAL Menu.....	109
Figure 55 LIN Trigger .....	111
Figure 56 LIN Decode .....	112
Figure 57 Reference Waveform .....	116
Figure 58 Addition .....	119
Figure 59 FFT Waveform in Split Mode .....	123
Figure 60 Differential Function Operation .....	125
Figure 61 Integral Without Offset .....	126
Figure 62 Integral With Offset .....	126
Figure 63 Square Root .....	127
Figure 64 Measure Pulse Width .....	129
Figure 65 Voltage Measurements .....	131
Figure 66 Overshoot .....	132
Figure 67 Preshoot .....	132
Figure 68 Time Measurements .....	133
Figure 69 Select the Measurement Parameter .....	135
Figure 70 Added the Measurements .....	136
Figure 71 All Parameters Measurement .....	137
Figure 72 Vector Display .....	139
Figure 73 Dots Display .....	139
Figure 74 Color Temperature .....	140
Figure 75 Persist Set To Infinite .....	141
Figure 76 SAVE / RECALL File System .....	148
Figure 77 Select Save Location .....	149
Figure 78 File Name Dialogue .....	149
Figure 79 Input Keyboard .....	152
Figure 80 Digital Function Menu .....	156
Figure 81 Digital Channel Height .....	156
Figure 82 Digital: High Display Type .....	157
Figure 83 Digital Thresholds Function Menu .....	158
Figure 84 Digital Bus Function Menu .....	159
Figure 85 Digital Bus .....	159

---

---

Figure 86 System Status .....	161
Figure 87 Do Self Cal .....	162
Figure 88 Pass / Fail Test .....	164
Figure 89 AWG Menu Interface .....	169
Figure 90 Wave Type Interface .....	169
Figure 91 Built-in Arb Interface .....	171
Figure 92 AWG Setting Interface .....	171
Figure 93 AWG System Information Interface .....	173
Figure 94 AWG Update Interface .....	174
Figure 95 LAN Settings .....	176
Figure 96 WIFI Setting Menu .....	177
Figure 97 Web Server Interface .....	179
Figure 98 Screen Test .....	181
Figure 99 Keyboard Test .....	182
Figure 100 LED Test .....	183
Figure 101 Screen Saver Interface .....	184
Figure 102 OPTION Function menu .....	186
Figure 103 LABEL Function Menu .....	186
Figure 104 Option Information .....	187
Figure 105 Search Menu .....	188
Figure 106 Search When Stopped .....	190
Figure 107 Search When Running .....	190
Figure 108 Bode Plot Menu .....	193
Figure 109 Bode Plot Configure Menu .....	193
Figure 110 Bode Plot Display Menu .....	194
Figure 111 Bode Plot Data Menu .....	195
Figure 112 Bode Plot List On .....	195
Figure 113 History .....	196

---

# Quick Start

This chapter introduces the preparations when using the oscilloscope for the first time, the front panel, rear panel and user interface.

The contents of this chapter:

- ◆ General Inspection
- ◆ Appearance and Dimensions
- ◆ To Prepare the Oscilloscope for Use
- ◆ Front Panel Overview
- ◆ Rear Panel Overview
- ◆ Front Panel Function Overview
- ◆ Back Panel Function Overview
- ◆ User Interface
- ◆ To Use the Security Lock

---

## General Inspection

### 1. Inspect the shipment for damage.

Keep the shipping box and cushioning material until the contents of the shipment have been checked for completeness and the instrument has passed both electrical and mechanical tests.

The shipper or carrier shall be liable for the damage to instrument resulting from shipment. **Teledyne Test Tools** would not be responsible for free maintenance / rework or replacement of the unit.

### 2. Inspect the instrument.

In case of any damage, or defect, or failure, notify your **Teledyne Test Tools** sales representative.

### 3. Check the Accessories

Please check the accessories according to the packing lists. If the accessories are incomplete or damaged, please contact your **Teledyne Test Tools** sales representative.

---

## Appearance and Dimensions

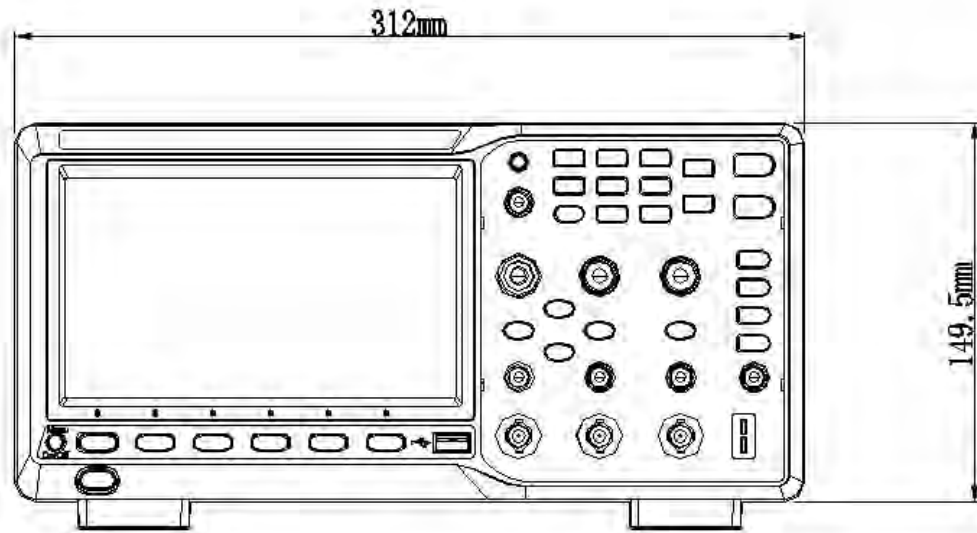

Figure 1 Front View (2-channel scope)

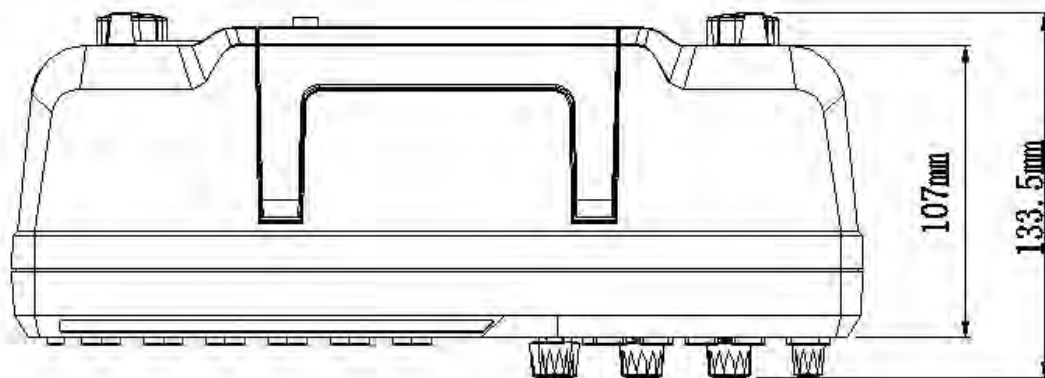

Figure 2 Top View (2-channel scope)

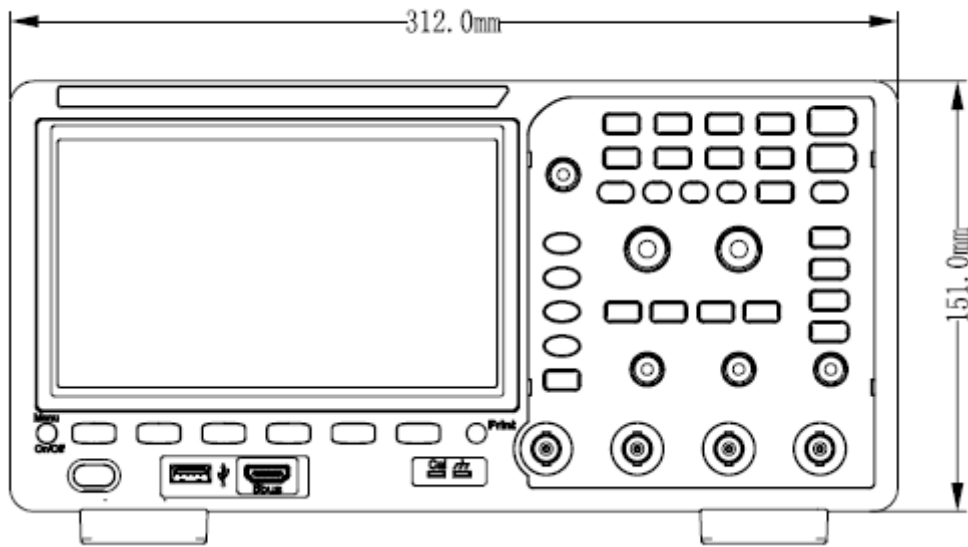

Figure 3 Front View (4-channel scope)

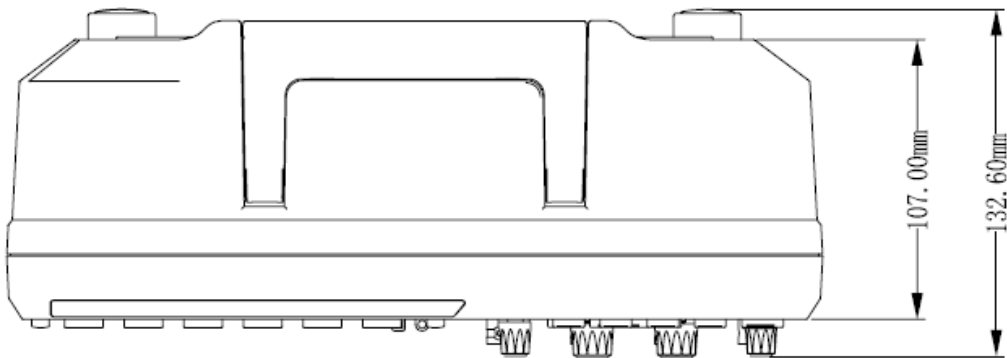

Figure 4 Top View (4-channel scope)

---

## To Prepare the Oscilloscope for Use

### To Adjust the Supporting Legs

Adjust the supporting legs properly to use them as stands to tilt the oscilloscope upwards for stable placement of the oscilloscope as well as better operation and observation.

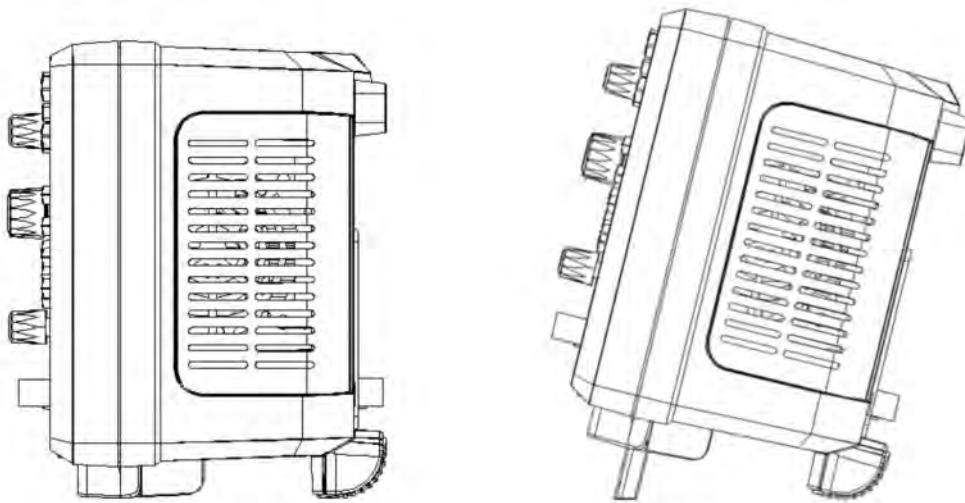

Figure 5 Adjust the Supporting Legs

---

## To Connect to the local line Power

The power requirements of the oscilloscope are 100-240 V, 50/60Hz or 100-120 V, 400Hz. Please use the power cord supplied with the accessories to connect the oscilloscope to the power source.

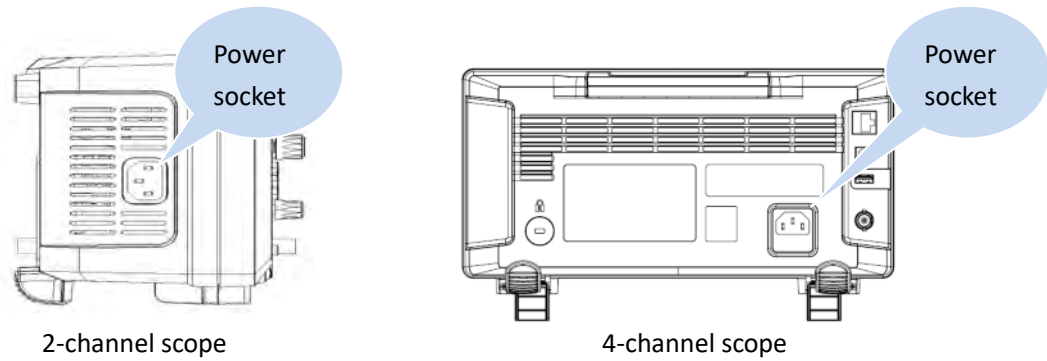

Figure 6 To Connect to Power Supply



---

## Power-on Inspection

When the oscilloscope is connected to line power, press the power key at the lower-left corner of the front panel to start the oscilloscope. During the start-up process, the oscilloscope performs a series of self-tests and you can hear the sound of relays switching. After the self-test is finished, the welcome screen is displayed.

## To Connect the Probe

**Teledyne Test Tools** provides passive probes for the oscilloscopes. For detailed technical information of the probes, please refer to the corresponding Probe User's Guide.

### Connect the Probe:

1. Connect the probe to an oscilloscope front channel BNC.
2. Connect the probe tip to the circuit point to be tested and connect the ground alligator clip of the probe to the circuit ground terminal.

---

## Function Inspection

1. Press the **Default** button on the front panel to restore the instrument to its default configuration.
2. Connect the ground alligator clip of the probe to the “Ground Terminal” under the probe compensation signal output terminal.

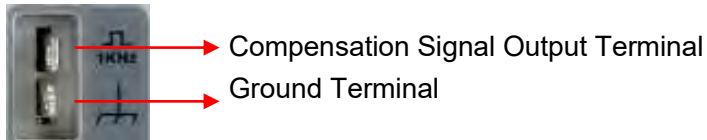

2-channel scope

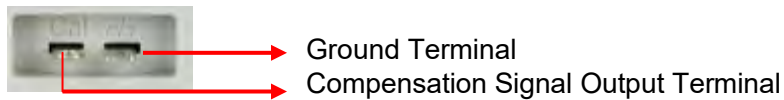

4-channel scope

3. Use the probe to connect the input terminal of CH1 of the oscilloscope to the “Compensation Signal Output Terminal” of the oscilloscope.
4. Press the **Auto Setup**.
5. Observe the waveform on the display. In normal condition, the display should be a square waveform as shown in the figure below:

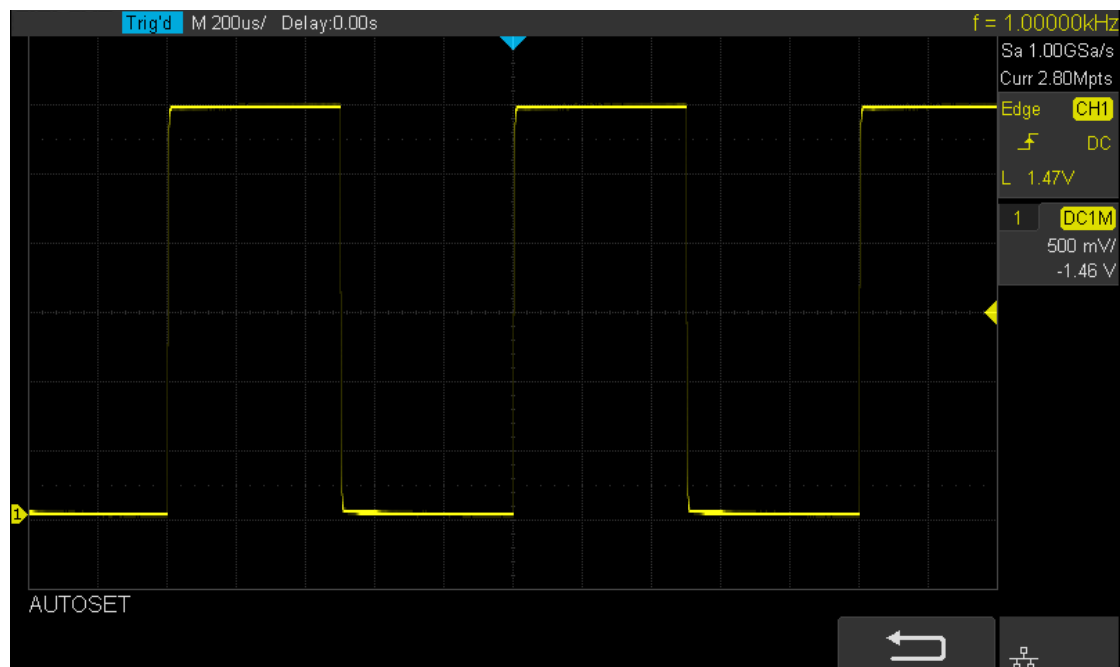

Figure 7 Function Inspection

6. Use the same method to test the other channels. If the square waveforms actually shown do not match that in the figure above, please perform “**Probe Compensation**”

---

in the next section.



---

**WARNING**

To avoid electric shock during the use of a probe, please make sure that the insulated wire of the probe is in good condition and do not touch the metallic part of the probe when the probe is connected to a high voltage source

---

## Probe Compensation

When the probes are used for the first time, you should compensate the probes to match the input channels of the oscilloscope. Non-compensated or poorly compensated probes may cause measurement inaccuracy or error. The probe compensation procedures are as follows.

1. Set the switch to 10X on the probe.
2. Perform steps 1, 2, 3 and 4 of **“Function Inspection”** in the previous section.
3. Check the waveforms displayed and compare them with the following:

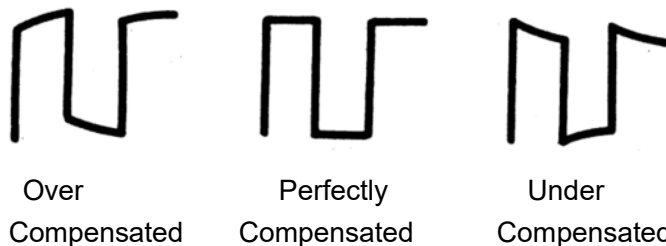

4. Use a nonmetallic screwdriver to adjust the low-frequency compensation adjustment hole on the probe until the waveform displayed is as the “Perfectly compensated” waveform in the figure above.

## Front Panel Overview



Figure 8 2-channel Scope Front Panel Overview

NO.	Description	NO.	Description
1	LCD Display	8	Vertical Control
2	Universal Knob	9	Probe Compensation/ Ground Terminal
3	Common Function Menus	10	Analog Channel and Ext Input
4	Run/Stop	11	USB Host
5	Auto Setup	12	Menu Softkey
6	Trigger Control	13	Menu on/off
7	Horizontal Control	14	Power Button



Figure 9 4-channel Scope Front Panel Overview

NO.	Description	NO.	Description
1	LCD Display	12	Horizontal Control
2	Universal Knob	13	Trigger Control
3	Common Function Menus	14	Menu on/off
4	Clear Sweeps	15	Menu Softkey
5	Run/Stop	16	One- Button shortcut for Save
6	Decode	17	Analog Channel
7	Auto Setup	18	Power Button
8	Navigate	19	USB Host
9	History	20	Digital Inputs
10	Default	21	Probe Compensation/ Ground Terminal
11	Vertical Control, Math, REF and Digital		

---

## Rear Panel Overview

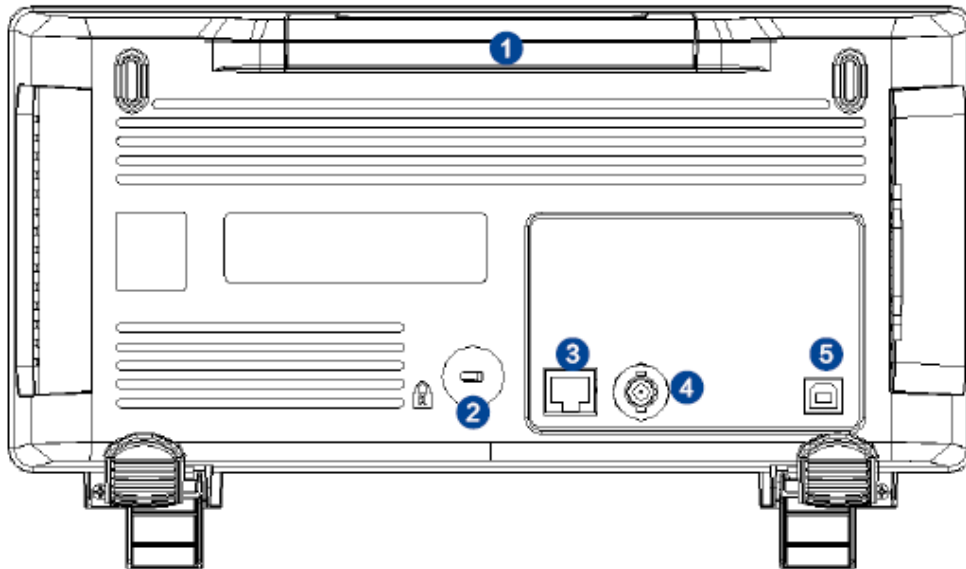

Figure 10 2-channel Scope Rear panel Overview

**1. Handle**

Pull up the handle vertically for easy carrying of the instrument. When you do not need the handle, press it down.

**2. Safety lock Hole**

You can lock the instrument to a fixed location using the security lock (not supplied) via the lock hole.

**3. LAN**

The instrument can be connected to network via this interface to perform remote control.

**4. Pass/Fail or Trigger Out**

The BNC port can output a signal that reflects the current waveform capture rate of the oscilloscope at each trigger or a pass/fail test pulse.

**5. USB Device**

The oscilloscope support SCPI remote control commands, user can control the oscilloscope through this interface.

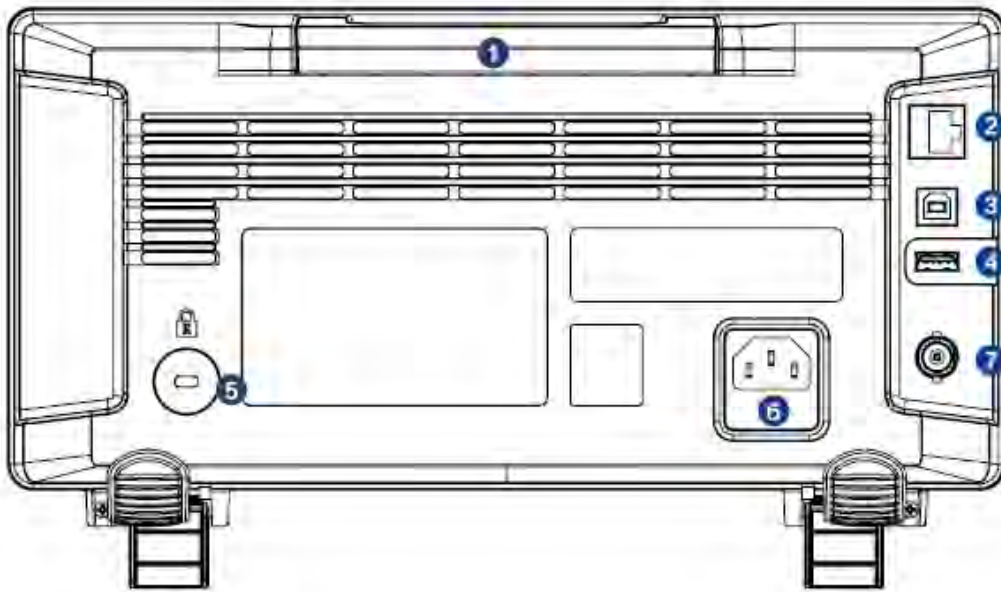

Figure 11 4-channel Scope Rear panel Overview

**1. Handle**

Pull up the handle vertically for easy carrying of the instrument. When you do not need the handle, press it down.

**2. LAN**

The instrument can be connected to network via this interface to perform remote control.

**3. USB Device**

The oscilloscope support SCPI remote control commands, user can control the oscilloscope through this interface

**4. USB Host**

**5. Safety lock Hole**

You can lock the instrument to a fixed location using the security lock (not supplied) via the lock hole.

**6. AC Power Socket**

AC power input connector. The power requirements of this oscilloscope are 100-240 V, 50/60/400 Hz. Use the power cord provided with the instrument to connect it to AC power.

**7. Pass/Fail or Trigger Out**

The BNC port can output a signal that reflects the current waveform capture rate of the oscilloscope at each trigger or a pass/fail test pulse.

---

## Front Panel Function Overview

### Horizontal



4-channel scope



2-channel scope



: Quickly enter the roll mode. The timebase range is from 50mS/div to 100S/div.

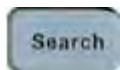

: Enable or disable search function. This function can search for the events that users specify in the acquired data, the results are displayed with a white triangle symbol.

#### Horizontal Position Knob



: adjust horizontal position. The trigger point would move left or right relative to the center of the screen when you turn the knob. During the modification, waveforms of all the channels would move left or right and the trigger position message at the upper-right corner of the screen would change accordingly. Press down this knob to quickly reset the trigger delay to Zero.

#### Horizontal Scale Knob



: adjust the horizontal time base. Turn clockwise to reduce the time base and turn counterclockwise to increase the time base. During the modification, waveforms of all the channels will be displayed in expanded or compressed mode and the time base message at the upper-left side of the screen would change accordingly. Press down this knob to quickly turn on Zoom function.



## Vertical

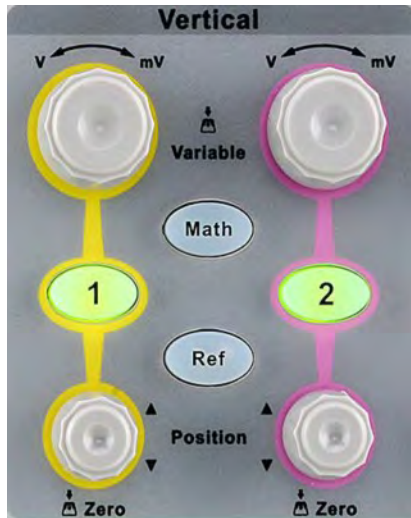



2-channel scope





4-channel scope

 : Analog input channels. The two channels are marked by different colors which are also used to mark both the corresponding waveforms on the screen and the channel input connectors.

**Vertical Position Knob**  : adjust the vertical position of the current channel waveform. Turn clockwise to increase the position and turn counterclockwise to decrease. During the modification, the waveform would move up and down and the position message at the lower-left corner of the screen would change accordingly. Press down this knob to quickly reset the vertical position to zero.

**Vertical Variable Knob**  : adjust the vertical scale of the current channel. Turn clockwise to decrease the scale and turn counterclockwise to increase. During the modification, the amplitude of the waveform would enlarge or reduce and the scale information at the right side of the screen would change accordingly. Press down this knob to quickly switch the vertical scale adjustment modes between “Coarse” and “Fine”.

 : press the button to enter the MATH function menu. The oscilloscope provides addition, subtraction, multiplication, FFT, differential, integral and square root operations.

 : press the button to enter the REF function menu. A reference waveform can be displayed and compared against other waveforms.

 Press the button to open the digital channel function menu (Optional function). The T3DSO1x04 (4-channel scope) supports 16 digital channels.

---

# Trigger



2-channel scope

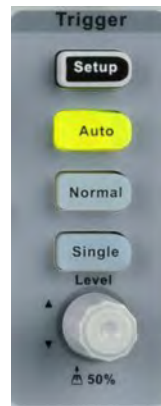

4-channel scope



: press the button to enter the TRIGGER function menu. The oscilloscope provides abundant advanced trigger functions

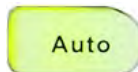

: press the button to set the trigger mode to Auto.



: press the button to set the trigger mode to Normal.

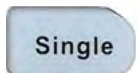

: press the button to set the trigger mode to Single.



**Trigger Level Knob** : adjust the trigger level. Turn clockwise to increase the level and turn counterclockwise to reduce the level. During the modification, the trigger level line would move up and down and the value in the trigger level message box at the up-right corner of the screen would change accordingly. Press down the knob to quickly reset the trigger level to center of the waveform.

---

## Run Control



: press this key to enable the waveform auto setting function. The oscilloscope will automatically adjust the vertical scale, horizontal time base and trigger mode according to the input signal to realize optimum waveform display.



: press the button to set the acquisition state to Run or Stop.  
In RUN state, the key is illuminated in yellow.  
In STOP state, the key is illuminated in red.

---

## Universal Knob



### 1. Adjust the waveform intensity.

You can press the **Display/Persist** button; press the **Next Page** softkey to go to the second page of the DISPLAY function menu; press the **Intensity** softkey and then turn the **Universal Knob** to adjust the waveform intensity.

### 2. Select the desired submenu.

In menu operation, press any menu softkey and turn the **Universal Knob** to select the desired submenu under the menu and push down the knob to confirm the current submenu. Turn clockwise to move up the submenu and counterclockwise to move down.

### 3. Modify parameters.

After having chosen a parameter, turn the **Universal Knob** to modify the value. Turn clockwise to increase the value and counterclockwise to reduce. In addition, it can also be used to adjust scale and offset of MATH and REF.

### 4. Choose file or directory or input filename.

After having entered the file system, turn the **Universal Knob** to select the desired file or directory. When inputting filename, turn the **Universal Knob** to select the desired character and then push the knob to confirm.

---

## Menu



2-channel scope common function panel

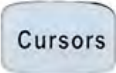
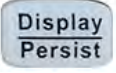
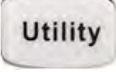
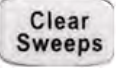
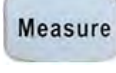
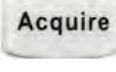
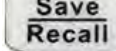

4-channel scope common function panel

-  : Press the button to enter the CURSOR function menu. The oscilloscope provides manual and track cursor mode.
-  : Press the button to enter the DISPLAY function menu and quickly enable the persist function. User can set the grid, intensity, graticule, transparency.
-  : Press the button to enter the UTILITY function menu to look at the system status, do self calibration, set the sound, language and so on.
-  : The button is a shortcut key for clear function. When the measurement statistics is ON, press the button to clear the count and recount it. When persist is enabled, press the button to clear persist.
-  : Press the button to enter the MEASURE function menu to set the measurement parameters, all measurements, statistics and set the gate.
-  : Press the button to enter the ACQUIRE function menu to set the acquisition mode, memory depth, wave interpolation and so on.
-  : Press the button to enter the SAVE/RECALL function menu to save setups, waveforms, pictures, or CSV files to internal memory or USB flash driver.



: Press the button to reset the oscilloscope to user default setup.

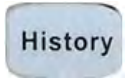

: Press the button to enter the history mode. In history mode, it can record up to 80,000 waveforms. If the sequence function is enabled, it will only record the waveforms which you set, the most you can set is 80,000.



: Press the button to enter the DECODE function menu. The oscilloscope supports I2C, SPI, UART/RS232, CAN and LIN serial bus decode.

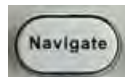

: Press the button to turn off or turn on the navigate function. T3DSO1x04 (4-channel scope) supports three navigate types: time, search event, history waveform.

---

## Help

The oscilloscope has an on line help function that supplies multi-language help information.

You can access the help function by pressing any button for 2 seconds and a help window will explain the function. Also all of the submenus include help information.

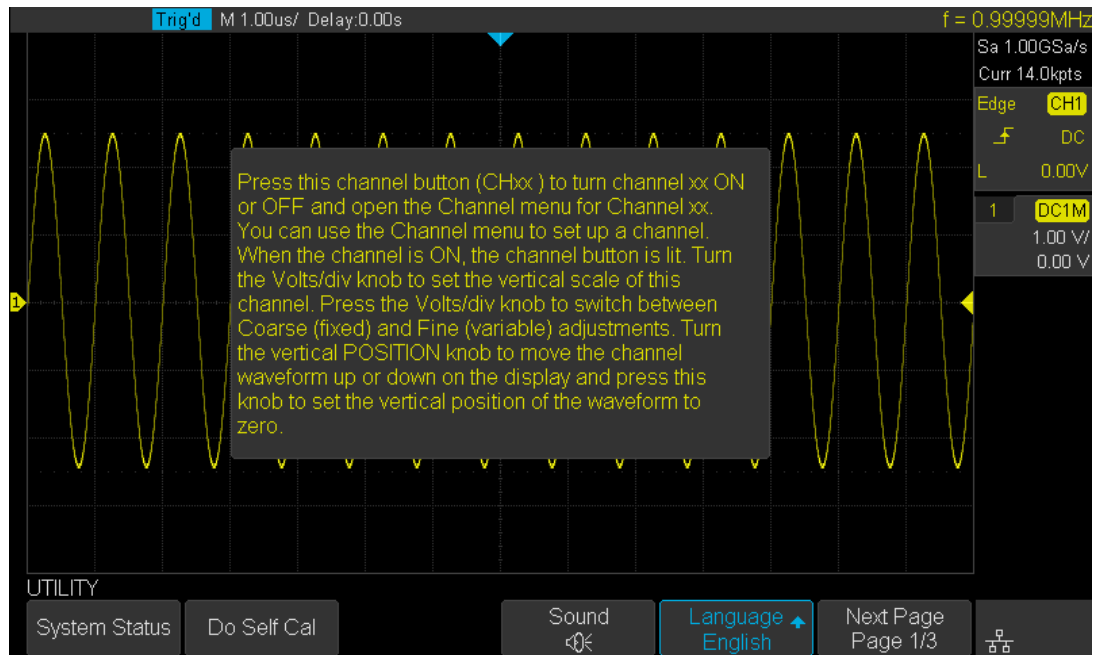

Figure 12 Help Message

## User Interface

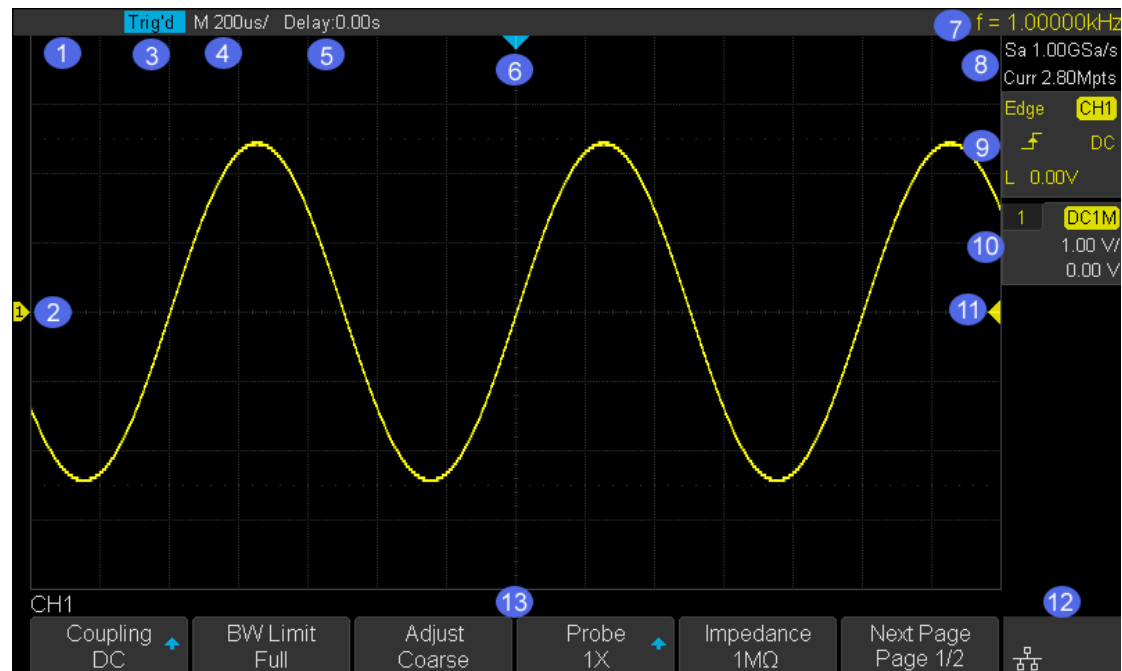

Figure 13 User Interface

### 1. Oscilloscope Display

The oscilloscope display is the main area to see most of the settings and the menus.

### 2. Channel Label/Waveform

Different channels are marked by different colors and the color of the waveform complies with the color of the channel.

### 3. Trigger Status

Available trigger status includes Ready, Auto, Stop, Arm, Trig'd.

### 4. Horizontal Time Base

- Represent the time per graticule on the horizontal axis on the screen.
- Use the **TIMEBASE Knob** to adjust the parameter. The available range is from 1.0 ns to 100 s.

### 5. Trigger Position

Turn the Horizontal Position Knob to adjust the delay. Push the knob to set the value to 0 (center of the screen) automatically.

### 6. Trigger Delay Label

Indicate the trigger zero time position on the waveform.



---

## 7. Frequency Counter

Display the frequency value of the trigger channel.

## 8. Sampling Rate/ Memory Depth

Display the current sampling rate and memory depth. Sa means the current sampling rate per second and Curr means the current memory depth.

## 9. Trigger Setup

Trigger Type  : display the current trigger type. The trigger type names display an abbreviation when the name is too long to display.

Trigger source  : displays the currently trigger source. Each channel displays in a different color.

Trigger condition  : display the current trigger condition.

Trigger coupling  : display the current trigger coupling. Available trigger coupling mode: DC, AC, HF Reject, LF Reject.

Trigger level  : display the current value of trigger level. Push the knob to set the trigger to the 50% of the waveform amplitude automatically.

## 10. Channel Setup

Probe attenuation factor  : display the current probe attenuation factor of the channel. Available probe attenuation factors: 0.1X, 0.2X, 0.5X, 1X, ...through to 2000X, 5000X, 10000X.

 Input impedance: display the current input impedance of the channel. Available Input impedance : 1MΩ.

Channel coupling  : display the current channel coupling of the channel. Channel coupling that are available: DC, AC, and GND.

Vertical Scale  : display the current vertical scale of the channel per division. Turn the Vertical Scale Knob to adjust the value.

## 11. Trigger Level Label

Display the position of trigger level, the trigger level indicator is colored the same as the channel triggered on. It can move from +4.5div to -4.5div of the screen center.

## 12. I/O status

 Indicate that the USB Host is connected.

 Indicate that the LAN port is connected.

 Indicate that the LAN port is disconnected.

 Indicate that the WLAN port is connected.

 Indicate that the WLAN port is disconnected.

## 13. Menu

Display the corresponding function menu of the selected button. Press the corresponding softkey to adjust the oscilloscope.

---

---

## To Use the Security Lock

If needed, you can use the security lock (not supplied) to lock the oscilloscope to a fixed location. The method is as follows, align the lock with the lock hole and plug it into the lock hole vertically, turn the key clockwise to lock the oscilloscope and then pull the key out.

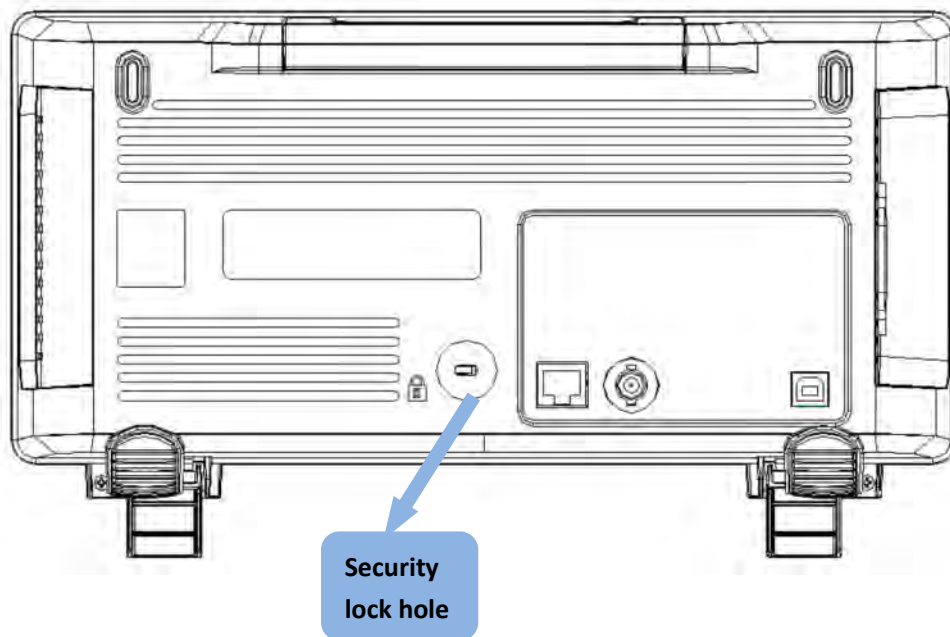

Figure 14 To Use the Security Lock

---

# To Set the Vertical System

This chapter introduces how to set the vertical system of the oscilloscope.

The contents of this chapter:

- ◆ To Enable the Channel
- ◆ To Adjust the Vertical Scale
- ◆ To Adjust the Vertical Position
- ◆ To Specify Channel Coupling
- ◆ To Specify Bandwidth Limit
- ◆ To Specify Probe Attenuation Factor
- ◆ To Specify channel Input Impedance
- ◆ To Specify Amplitude Unit
- ◆ To Specify Deskew
- ◆ To Invert a Waveform

---

## To Enable the Channel

The oscilloscope provides 2 or 4 analog input channels and provides independent vertical controls for each channel. This chapter takes CH1 as an example since all of the vertical channel setting methods are the same for all other channels.

Connect a signal to the CH1 channel BNC connector; and then press the **CH1** button in the vertical control area (VERTICAL) on the front panel to enable CH1 and illuminate the CH1 button.

The channel setting menu is displayed at the bottom of the screen and the channel label at the right side of the screen. The information displayed in the channel label is related to the current channel setting.

After the channel is turned on, modify the parameters such as the vertical scale, the horizontal time base and the trigger mode according to the input signal to make the waveform display easy to observe and measure.

Note: to turn off the channel, press the channel button until the channel indication light is no longer illuminated.

---

## To Adjust the Vertical Scale

The vertical scale can be adjusted in **Coarse** or **Fine** mode.

- **Coarse** adjustment (take counterclockwise as an example): set the vertical scale in 1-2-5 steps namely 500uV/div, 1 mV/div, 2 mV/div, 5 mV/div, 10 mV/div ...10 V/div.
- **Fine** adjustment: Adjust the vertical scale within a finer adjustment range to improve vertical resolution. For example: 2 V/div, 1.98V/div, 1.96V/div, 1.94 V/div ...1 V/div.

Use: If the amplitude of the input waveform is a little greater than the display full scale under the current scale settings, and the amplitude would be too low if the next scale is used, then fine adjustment can be used to optimise the amplitude of waveform display to correctly view the signal details.

Press the **CH1** button on the front panel; then press the **Adjust** softkey to select the desired mode. Turn the **VERTICAL Variable Knob** to adjust the vertical scale (clockwise to reduce the scale and counterclockwise to increase).

The scale information in the channel label at the right side of the screen will change accordingly during the adjustment. The adjustable range of the vertical scale is related to the probe ratio currently set. By default, the probe attenuation factor is 1X and the adjustable range of the vertical scale is from 500uV/div to 10 V/div.

Note: push the **VERTICAL Variable Knob** to quickly switch between **Coarse** and **Fine** adjustments.

## To Adjust the Vertical Position

Turn the **VERTICAL Position Knob** to adjust the vertical position of the channel waveform. Turn the knob clockwise to increase the vertical position and the channel waveform moves up while counterclockwise to reduce the vertical position and the waveform moves down. Push the knob to set the vertical position of the channel waveform to zero.

During the adjustment, the vertical position information Volts Pos displays at the bottom of the screen. The table below shows the range of vertical position according to the volt scale.

Volt Scale	Range of Vertical Position
500 $\mu$ V/div ~ 100 mV/div	$\pm$ 2V
102 mV/div ~ 1 V/div	$\pm$ 20 V
1.02 V/div ~ 10 V/div	$\pm$ 200 V

---

## To Specify Channel Coupling

Set the coupling mode to filter out the undesired signals. For example, the signal under test is a square waveform with DC offset.

- When the coupling mode set to **DC**: the DC and AC components of the signal under test can both pass into the scope measurement channel.
- When the coupling mode set to **AC**: the DC components of the signal under test are blocked.
- When the coupling mode set to **GND**: the DC and AC components of the signal under test are both blocked.

Press the **CH1** button on the front panel; then press the **Coupling** softkey and turn the **Universal Knob** to select the desired coupling mode. The default setup is **DC**.

The current coupling mode is displayed in the channel label at the right side of the screen. You can also press the **Coupling** softkey continuously to switch the coupling mode.

## To Specify Bandwidth Limit

Set the bandwidth limit to reduce display noise. For example, the signal under test is a pulse with high frequency oscillation.

- When the bandwidth limit set to **Full**, the high frequency components of the signal under test can pass into the scope measurement channel.
- When the bandwidth limit set to **20M**, the high frequency components that exceed 20 MHz are attenuated.

Press the **CH1** button on the front panel; then press the **BW Limit** softkey to select **Full** or **20M**. The default setup is **Full**. When bandwidth limit is enabled, the character **B** will be displayed in the channel label at the right side of the screen.

T3DSO1000 has full BW at all V/div settings including 500uV/div to 2mV/div.

---

## To Specify Probe Attenuation Factor

Set the probe attenuation factor to match the type of the probe that you are using to ensure correct vertical readouts.

Press the **CH1** button on the front panel; then press the **Probe** softkey and turn the **Universal Knob** to select the desired value and push the knob to confirm. The default setup is **1X**.

The current probe attenuation factor is displayed in the channel label at the right side of the screen. You can also press the **Probe** softkey continuously to switch the probe attenuation factor.

The table shows the probe attenuation factor

Menu	Attenuation Factor
0.1X	0.1 : 1
0.2X	0.2 : 1
0.5X	0.5 : 1
1X	1 : 1
2X	2 : 1
...	...
5000X	5000 : 1
10000X	10000 : 1

## To Specify channel Input Impedance

The channel input impedance is  $1M\Omega$ .

- Impedance setting to  $1M\Omega$  is for use with many passive probes and for general-purpose measurements. The higher impedance minimizes the loading effect of the oscilloscope on the device under test.

The current channel input impedance is displayed in the channel label at the right side of the screen.

---

## To Specify Amplitude Unit

Select the amplitude display unit for the current channel. The available units are **V** and **A**. When the unit is changed, the unit displayed in the channel label will change accordingly.

1. Press **CH1** button on the front panel to enter the CH1 function menu.
2. Press the **Next Page** softkey to enter the second page of the CH1 function menu.
3. Press the **Unit** softkey to select the desired unit **V** or **A**.

The default setup is **V**.

## To Specify Deskew

The valid range of each analog channel is  $\pm 100\text{ns}$ .

1. Press **CH1** button on the front panel to enter the CH1 function menu.
2. Press the **Next Page** softkey to enter the second page of the CH1 function menu.
3. Press the **Deskew** softkey. Then turn the **Universal Knob** to change deskew.

## To Invert a Waveform

When **Invert** is set to **On**, the voltage values of the displayed waveform are inverted. Invert affects how a channel is displayed but keeps the original trigger settings.

Inverting a channel also changes the result of any math function selected and measure function.

1. Press **CH1** button on the front panel to enter the CH1 function menu.
2. Press the **Next Page** softkey to enter the second page of the CH1 function menu.
3. Press the **Invert** softkey to turn on or off the invert display.



---

# Set the Horizontal System

This chapter introduces how to set the horizontal system of the oscilloscope.

The contents of this chapter:

- ◆ Adjust the Horizontal Scale
- ◆ Adjust the Trigger Delay
- ◆ Set Roll Mode
- ◆ Use the Zoom Function

---

## Adjust the Horizontal Scale

Turn the **HORIZONTAL Scale Knob** on the front panel to adjust the horizontal time base. Turn clockwise to reduce the horizontal time base and turn counterclockwise to increase.

The time base information at the upper left corner of the screen will change accordingly during the adjustment. The range of the horizontal scale is from 1ns/div to 100s/div.

**The Horizontal Scale Knob** works (in the Normal time mode) while acquisitions are running or when they are stopped. When in run mode, adjusting the horizontal scale knob changes the sample rate. When stopped, adjusting the horizontal scale knob lets you zoom into acquired data.

---

## Adjust Trigger Delay

Turn the Position Knob on the front panel to adjust the trigger delay of the waveform. During the modification, waveforms of all the channels would move left or right and the trigger delay message at the upper-right corner of the screen would change accordingly. Press down this knob to quickly reset the trigger delay to the center of the screen.

Changing the delay time moves the trigger point (solid inverted triangle) horizontally and indicates how far it is from the time reference point. These reference points are indicated along the top of the display grid.

All events displayed left of the trigger point happened before the trigger occurred. These events are called pre- trigger information, and they show events that led up to the trigger point.

Everything to the right of the trigger point is called post- trigger information. The amount of delay range (pre- trigger and post- trigger information) available depends on the time/div selected and memory depth.

The position knob works (in the Normal time mode) while acquisitions are running or when they are stopped.

---

## Set the Roll mode

Press the **Roll** button to enter the roll mode.

In Roll mode the waveform moves slowly across the screen from right to left. It only operates on time base settings of 50 ms/div and slower. If the current time base setting is faster than the 50 ms/div limit, it will be set to 50 ms/div when Roll mode is entered.

In Roll mode there is no trigger. The fixed reference point on the screen is the right edge of the screen and refers to the current moment in time. Events that have occurred are scrolled to the left of the reference point. Since there is no trigger, no pre-trigger information is available.

If you would like to stop the display in Roll mode, press the **Run/Stop** button. To clear the display and restart an acquisition in Roll mode, press the **Run/Stop** button again.

Use Roll mode on low- frequency waveforms to yield a display much like a strip chart recorder. It allows the waveform to roll across the display.

---

## Use the Zoom Function

Zoom is a horizontally expanded version of the normal display. You can use Zoom to locate and horizontally expand part of the normal window for a more detailed (higher-resolution) analysis of signals.

Press the **HORIZONTAL Scale Knob** on the front panel to turn on the zoom function, and press the button again to turn off the function. When Zoom function is on, the display divides in half. The top half of the display shows the normal time base window and the bottom half displays a faster Zoom time base window.

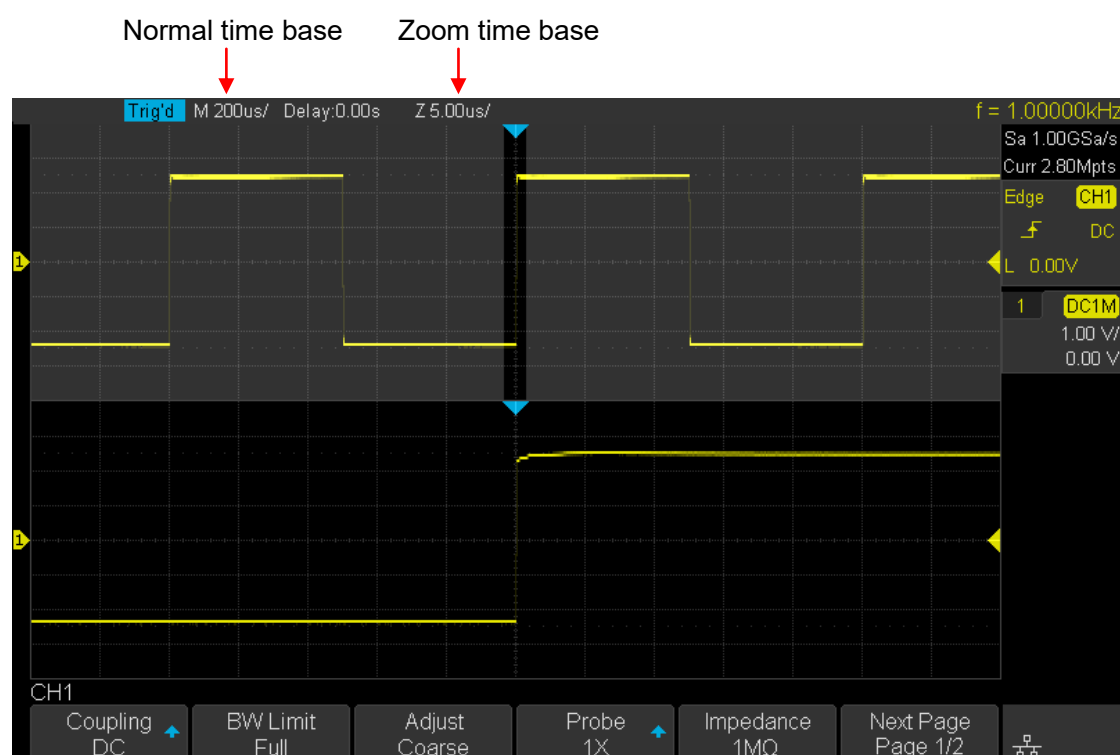

The area of the normal display that is expanded is outlined with a box and the rest of the normal display has a grey mask. The box shows the portion of the normal sweep that is expanded in the lower half.

To change the time base for the Zoom window, turn the **Horizontal Scale Knob**. The **Horizontal Scale Knob** controls the size of the box. The **Horizontal Position Knob** sets the left-to-right position of the zoom window. The delay value, which is the time displayed relative to the trigger point is momentarily displayed in the upper-right corner of the display when the **Horizontal Position Knob** is turned. Negative delay values indicate you're looking at a portion of the waveform before the trigger event, and positive values indicate you're looking at the waveform after the trigger event.

To change the time base of the normal window, turn off Zoom; then, turn the **Horizontal Scale Knob**.

---

# To Set the Sampling System

This chapter introduces how to use the run control and set the sampling system of the oscilloscope.

The contents of this chapter:

- ◆ Run Control
- ◆ Overview of Sampling
- ◆ To Specify Memory Depth
- ◆ To Select Sampling Mode
- ◆ Waveform Interpolation Method

---

## Run Control

Press the **Run/Stop** or **Single** button on the front panel to run or stop the sampling system of the scope.

- When the **Run/Stop** is green, the oscilloscope is running, that is, acquiring data when trigger conditions are met. To stop acquiring data, press the **Run/Stop** button. When stopped, the last acquired waveform is displayed.
- When the **Run/Stop** button is red, data acquisition is stopped. Red "Stop" is displayed in the status line at the top of the display. To start acquiring data, press **Run/Stop**.
- To capture and display a single acquisition (whether the oscilloscope is running or stopped), press **Single**. The **Single** run control lets you view single-shot events without subsequent waveform data overwriting the display. Use **Single** when you want maximum memory depth for pan and zoom.

When you press **Single**, the display is cleared, the trigger mode is temporarily set to Normal (to keep the oscilloscope from auto-triggering immediately), the trigger circuitry is armed, the **Single** key is illuminated, and the oscilloscope waits until a user defined trigger condition occurs before it displays a waveform.

When the oscilloscope triggers, the single acquisition is displayed and the oscilloscope is stopped (the **Run/Stop** button is illuminated in red).

Press **Single** again to acquire another waveform

---

## Overview of Sampling

To understand the oscilloscope's sampling and acquisition modes, it is helpful to understand sampling theory, sample rate and oscilloscope bandwidth and sample rate.

## Sampling Theory

The Nyquist sampling theorem states that for a limited bandwidth (band-limited) signal with maximum frequency  $f_{MAX}$ , the equally spaced sampling frequency  $f_S$  must be greater than twice the maximum frequency  $f_{MAX}$ , in order to have the signal be uniquely reconstructed without aliasing.

$f_{MAX} = f_{S/2} = \text{Nyquist frequency } (f_N) = \text{folding frequency}$



---

## Sample Rate

The maximum sample rate of the oscilloscope is 2GSa/s. The actual sample rate of the oscilloscope is determined by the horizontal scale. Turn the **Horizontal Scale Knob** to adjust the sample rate.

The actual sample rate is displayed in the information area at the upper-right corner of the screen.

The influence on the waveform when the sample rate is too low:

1. **Waveform Distortion:** when the sample rate is too low, some waveform details are lost and the waveform displayed is rather different from the actual signal.

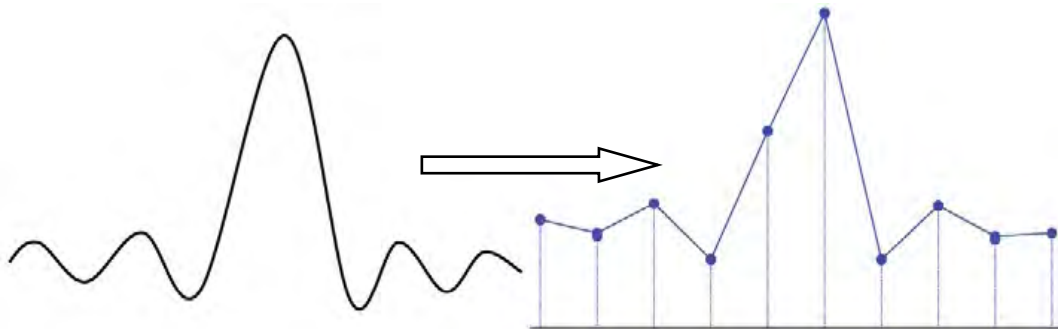

2. **Waveform Aliasing:** when the sample rate is lower than twice the actual signal frequency (Nyquist Frequency), the frequency of the waveform rebuilt from the sample data is lower than the actual signal frequency. The most common aliasing is the jitter on a fast edge.

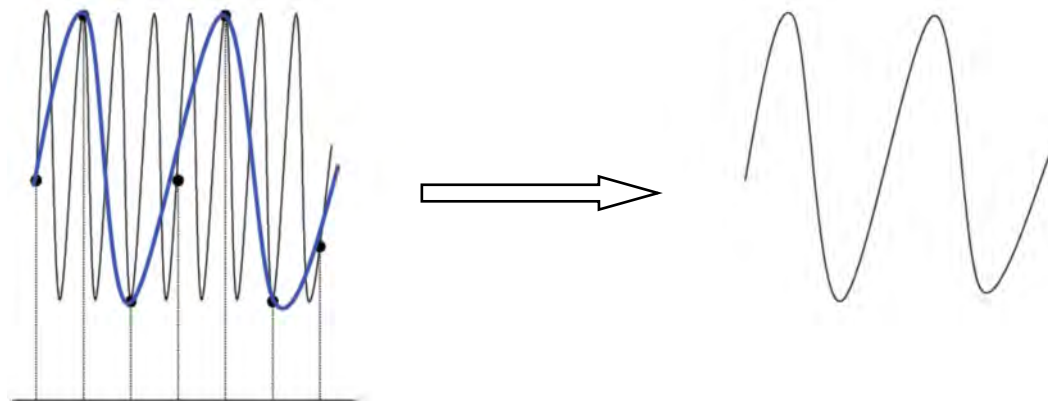

3. **Waveform Leakage:** when the sample rate is too low, the waveform rebuilt from the sample data does not reflect all the actual signal information.

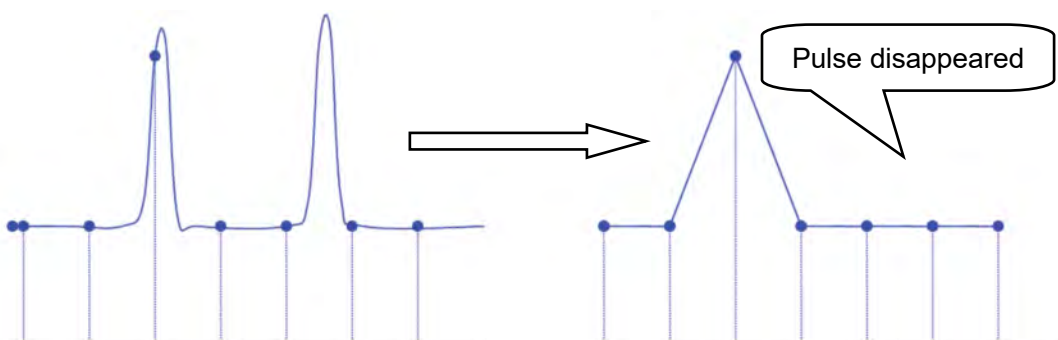

---

## Oscilloscope Bandwidth and Sample Rate

An oscilloscope's bandwidth is typically described as the lowest frequency at which input signal sine waves are attenuated by 3 dB (- 30% amplitude error).

At the oscilloscope bandwidth, sampling theory says the required sample rate is  $f_s = 2f_{BW}$ . However, the theory assumes there are no frequency components above  $f_{MAX}$  ( $f_{BW}$  in this case) and it requires a system with an ideal brick-wall frequency response.

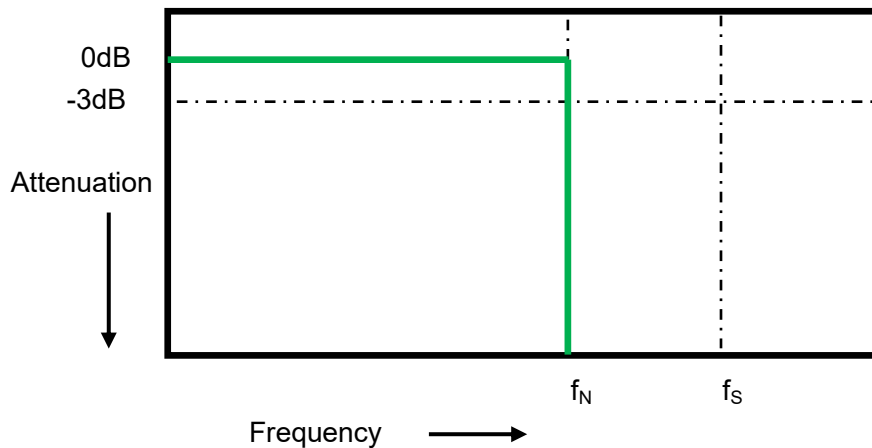

However, digital signals have frequency components above the fundamental frequency (square waves are made up of sine waves at the fundamental frequency and an infinite number of odd harmonics), and typically, for 500 MHz bandwidths and below, oscilloscopes have a Gaussian frequency response.

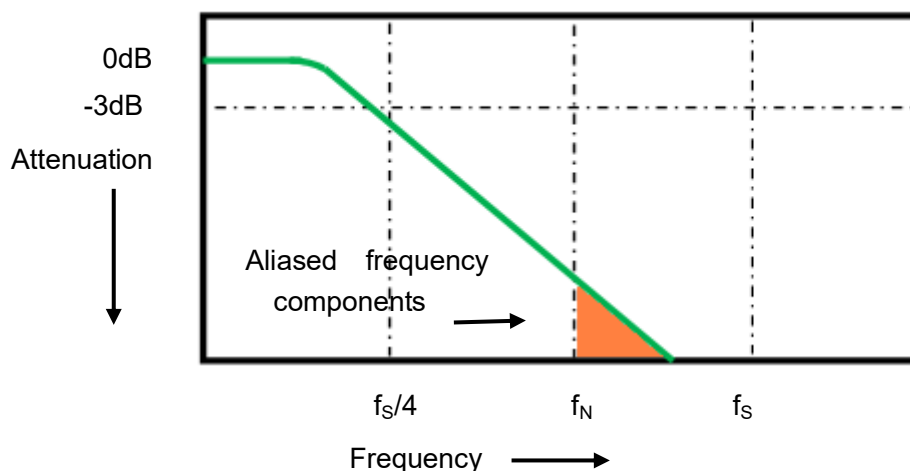

Limiting oscilloscope bandwidth ( $f_{BW}$ ) to 1/4 the sample rate ( $f_s/4$ ) reduces frequency components above the Nyquist frequency ( $f_N$ ).

So, in practice, an oscilloscope's sample rate should be four or more times its bandwidth:  $f_s = 4f_{BW}$ . This way, there is less aliasing, and aliased frequency components have a greater amount of attenuation.

---

## Select Memory Depth

Memory depth refers to the number of waveform points that the oscilloscope can store in a single trigger sample and it reflects the storage ability of the sample memory. The oscilloscope provides up to 14 Mpts memory depth.

Press the **Acquire** button on the front panel; press the **Mem Depth** softkey and then turn the **Universal Knob** to select the desired value and push down the knob to confirm. Press the **Mem Depth** softkey continually can also select the desired value.

The actual memory depth is displayed in the information area at the upper- right corner of the screen. Memory depths that are available: 14K, 140K, 1.4M, 14M.

Since the oscilloscope has two acquisition memories, when only one channel is on, the maximal memory depth is up to 14 Mpts.

The relation of memory depth, sample rate and waveform length fulfils the equation below:

Memory depth = sample rate (Sa/s) × waveform length (s/div × div)

---

## Select Sampling Mode

The oscilloscope only supports real-time sampling. In this mode, the oscilloscope samples and displays a waveform within a trigger event. The maximum real-time sample rate is 1GSa/s.

Press the **RUN/STOP** button to stop the sampling, the oscilloscope will hold the last display. At this point, you can still use the vertical control and horizontal control to pan and zoom the waveform.

---

## Select Waveform Interpolation Method

Under real-time sampling, the oscilloscope acquires the discrete sample values of the waveform being displayed. In general, a waveform of dots display type is very difficult to observe. In order to increase the visibility of the signal, the digital oscilloscope usually uses the interpolation method to display a waveform.

Interpolation method is a processing method to “connect all the sampling points”, and uses the points to calculate the whole appearance of the waveform. For real-time Sampling, interpolation method is used, even if the oscilloscope is in a single capture mode and only a small number of sampling points are captured. The oscilloscope can use interpolation for filling in the gaps between points to reconstruct an accurate waveform.

Press the **Acquire** button on the front panel to enter the ACQUIRE Function menu; then press the **Interpolation** softkey to select **Sinx/x** or **X**.

- **X**: The adjacent sample points are directly connected with a straight line. This method is only used to rebuild on the fast edge of signals, such as a square wave.
- **Sinx/x**: Connecting the sampling points with curves has greater versatility. Sinx/x interpolation method uses mathematical processing to calculation results in between the actual sample points. This method smoothes the signal waveform, and gives it a more realistic regular shape than straight line connected sample points. When the sampling rate is relatively low, less than 5 times the bandwidth of the highest frequency of the waveform, it is recommended to use the Sinx/s interpolation method.

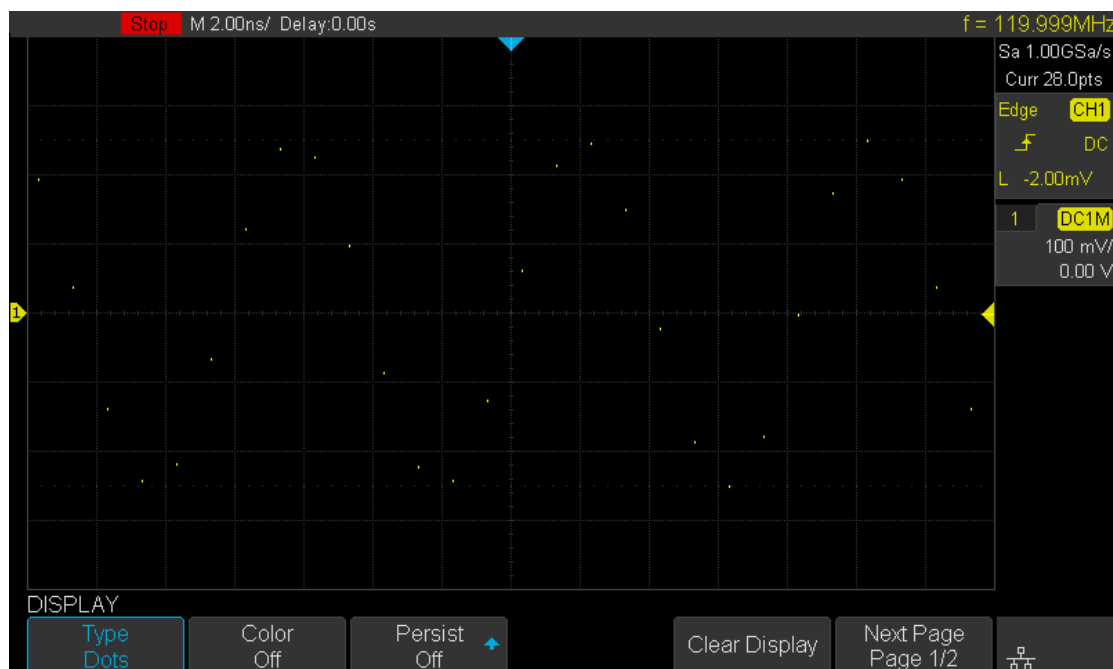

Figure 15 Display Type Set to Dots

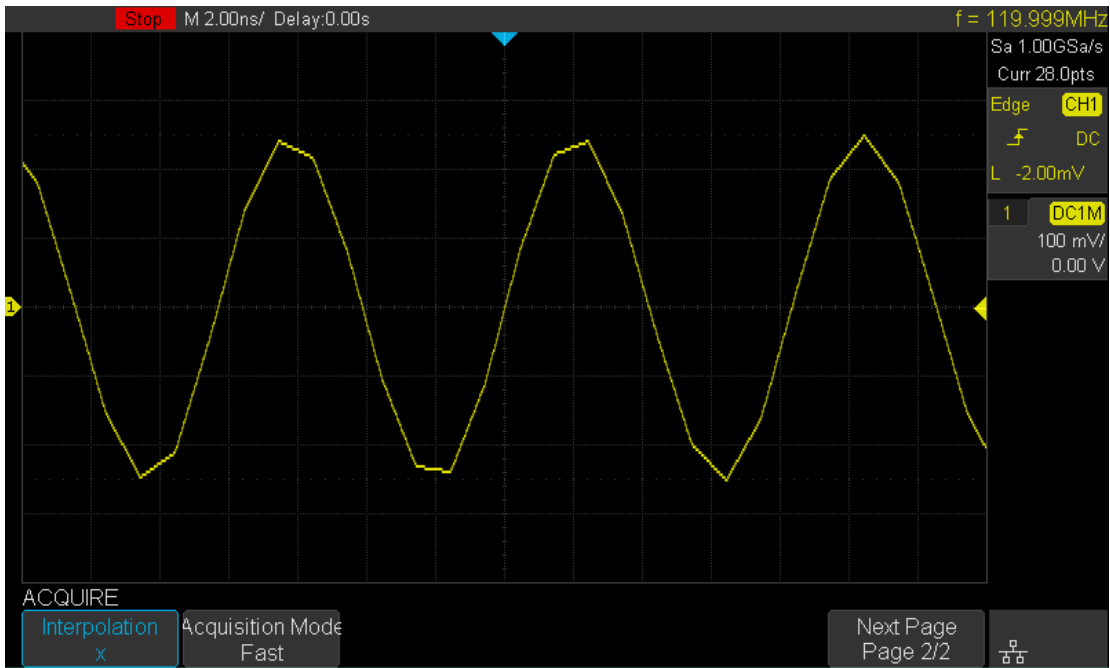

Figure 16 x Interpolation

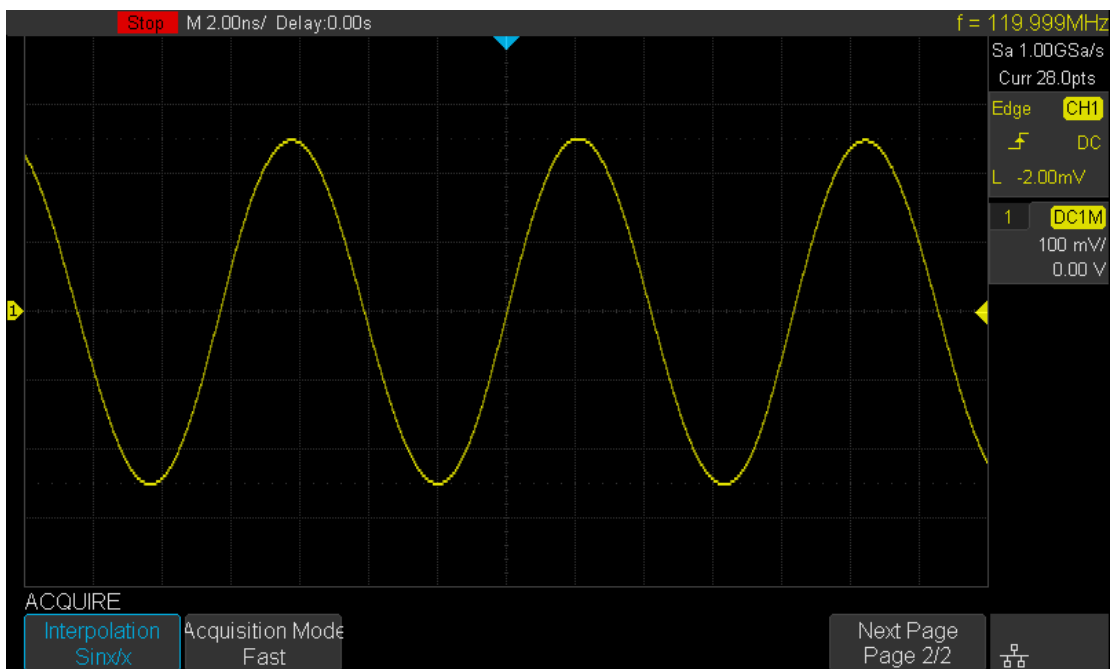

Figure 17 Sinx/x Interpolation

---

## Select Acquisition Mode

The acquisition mode is used to control how to generate waveform points from sample points. The oscilloscope provides the following acquisition mode: Normal, Peak Detect, Average and High Resolution.

1. Press the **Acquire** button on the front panel to enter the ACQUIRE function menu;
2. Press the **Acquisition** softkey; then turn the **Universal Knob** to select the desired acquisition mode and push down the knob to confirm. The default setup is **Normal**.

### Normal

In this mode, the oscilloscope samples the signal at equal time interval to rebuild the waveform. For most of the waveforms, the best display effect can be obtained using this mode. It is the default acquisition mode.

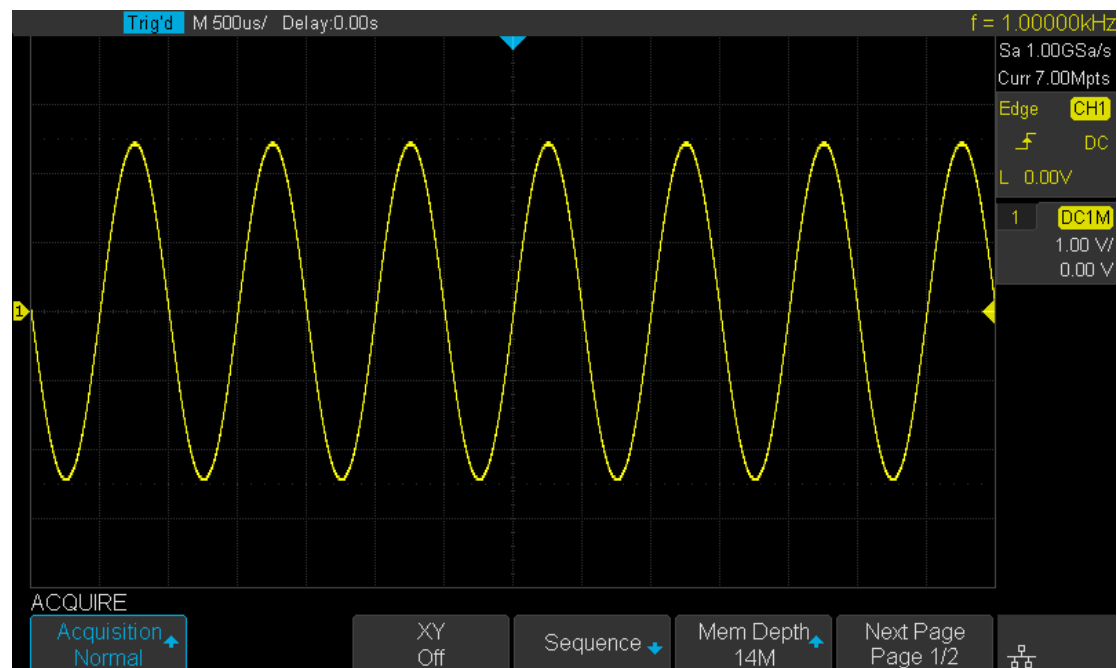

Figure 18 Acquisition System

## Peak Detect

In this mode, the oscilloscope acquires the maximum and minimum values of the signal within the sample interval to get the envelope of the signal or the narrow pulse of the signal that might be lost. In this mode, signal loss can be prevented but displayed noise will increase.

In this mode, the oscilloscope can display all the pulses with pulse widths at least as wide as the sample period.

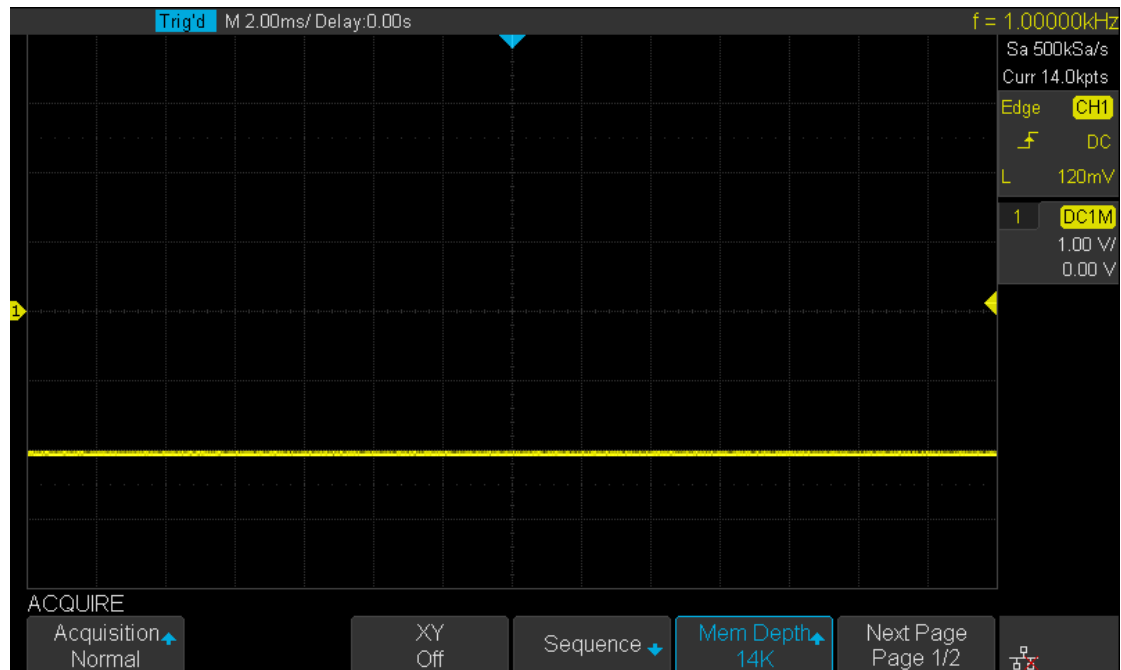

Figure 19 Pulse With 0.1% Duty, Normal Mode

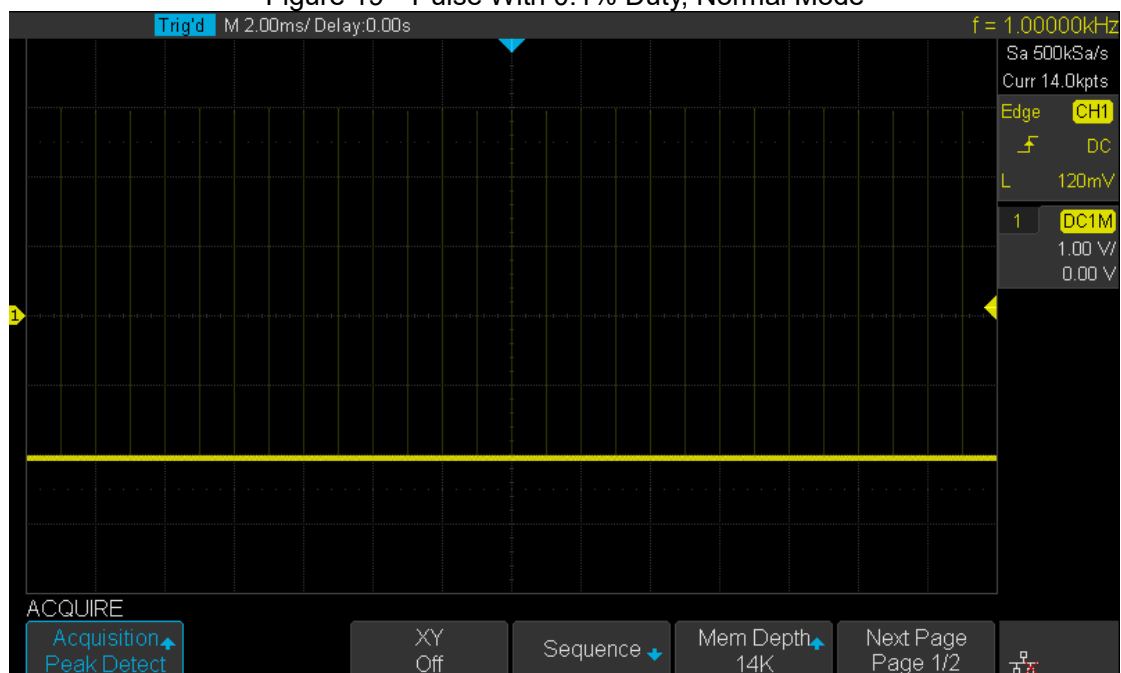

Figure 20 Pulse With 0.1% Duty, Peak Detect Mode



---

## Average

In this mode, the oscilloscope averages the waveforms from multiple acquisitions to reduce the random noise of the input signal and improve the vertical resolution. The greater the number of averages, the lower the noise will be, and the higher the vertical resolution will be, but the slower the response of the displayed waveform to waveform changes.

The available range of averages is from 4 to 1024 and the default is 16. When Average mode is selected, press **Averages** and turn the universal knob or press the softkey continually to set the desired average time.

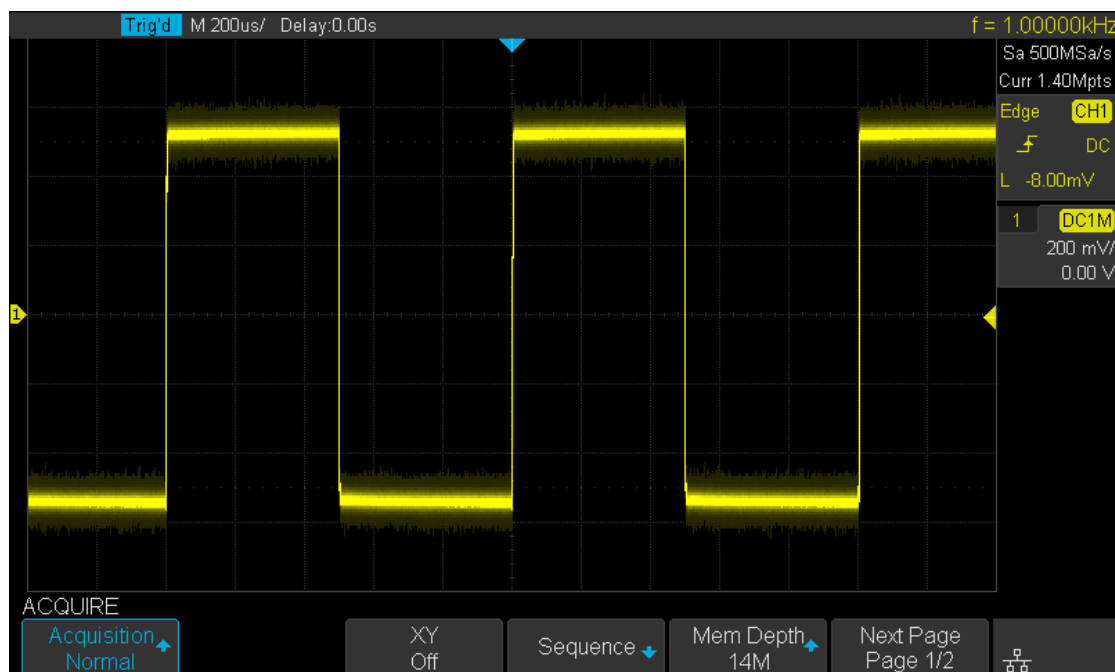

Figure 21 With Random Noise, Normal Mode

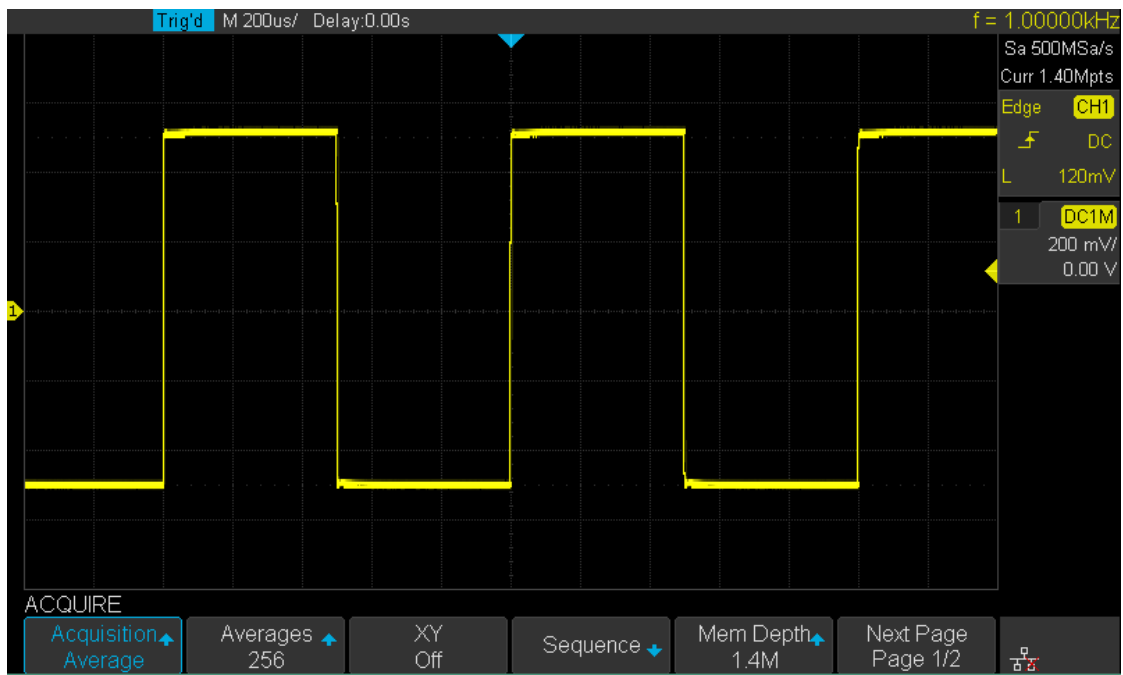

Figure 22 With Random Noise, Average Mode

## High Resolution

This mode uses a linear averaging technique to average the neighbouring points of the sample waveform to reduce the random noise on the input signal and generate much smoother waveforms on the screen.

High Resolution mode can be used on both single shot and repetitive signals, and it does not slow waveform update. This mode limits the oscilloscope's real time bandwidth because it effectively acts like a low pass filter.

Note: "Average" and "High Res" modes use different averaging methods. The former uses "Waveform Average" and the latter uses "Linear Average".

---

## Change the Horizontal Format

Press the **Acquire** button on the front panel; then press the **XY** soft key to set the XY(On) or YT(Off) mode. The default setup is **YT**.

### YT

It is the normal viewing mode for the oscilloscope. In the Normal time mode, signal events occurring before the trigger are shown to the left of the trigger point and signal events after the trigger point are displayed to the right of the trigger point.

### XY

XY mode changes the display from a volt- versus- time display to a volt- versus- volt display. Channel 1 amplitude is plotted on the X- axis and Channel 2 amplitude is plotted on the Y- axis, the two channels will be turned on or off together.

You can use XY mode to compare frequency and phase relationships between two signals. XY mode can also be used with transducers to display strain versus displacement, flow versus pressure, volts versus current, or voltage versus frequency.

The phase deviation between two signals with the same frequency can be easily measured via Lissajous method. The figure below shows the measurement schematic diagram of the phase deviation

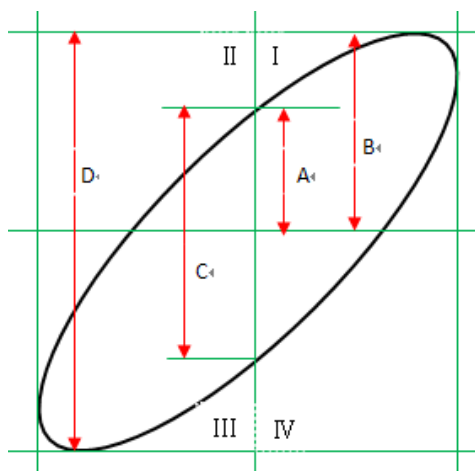

According to  $\sin\theta=A/B$  or  $C/D$  (wherein,  $\theta$  is the phase deviation angle between the two channels and the definitions of A, B, C and D are as shown in the figure above), the phase deviation angle is obtained, that is:  $\theta=\pm\arcsin(A/B)$  or  $\pm\arcsin(C/D)$

If the principal axis of the ellipse is within quadrant I and III, the phase deviation angle obtained should be within quadrant I and IV, namely within  $(0$  to  $\pi/2)$  or  $(3\pi/2$  to  $2\pi)$ . If the principal axis of the ellipse is within quadrant II and IV, the phase deviation angle obtained should be within quadrant II and III, namely within  $(\pi/2$  to  $\pi)$  or  $(\pi$  to  $3\pi/2)$ .

X-Y function can be used to measure the phase deviation occurred when the signal under test passes through a circuit network. Connect the oscilloscope to the circuit to monitor the input and output signals of the circuit.

---

## Use Sequence Mode

Sequence is also an acquisition mode, which does not display a waveform during the sampling process. This improves the waveform capture rate, to a maximal capture rate of 400,000 wfs/s. So it can capture the small probability events effectively. The oscilloscope runs and fills a memory segment for each trigger event. The oscilloscope screen is not updated whilst the oscilloscope is busy acquiring multiple segments. The oscilloscope continues to trigger until memory is filled, and then displays the waveforms on the screen. To use the sequence mode, the HORIZONTAL Format must be set to **YT**.

Do the following steps to use the sequence mode.

1. Press the **Acquire** button on the front panel to enter the ACQUIRE function menu;
2. Press the **Sequence** softkey to enter the SEQUENCE function menu.



Figure 23 SEQUENCE Function Menu

3. Press the **Segments Set** softkey; and then turn the **Universal Knob** to select the desired value.

Do the following steps to replay the sequence waveform under history mode:

1. Press the **History** softkey to enable HISTORY function .

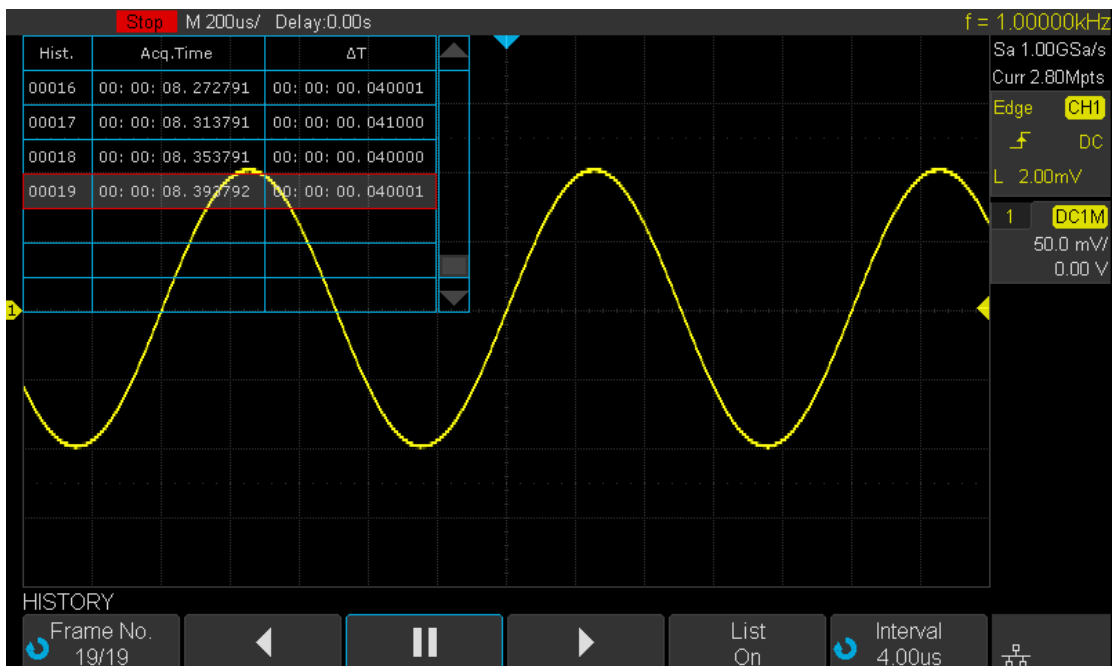





Figure 24 HISTORY Function Menu

2. Press the **List** softkey to turn on the list display. The list records the acquisition time of every frame and shows the frame number that is displaying on the screen.
3. Press the **Frame No.** softkey; and then turn the **Universal Knob** to select the frame to display.

- 
4. Press the  softkey to replay the waveform from the current frame to 1.
  5. Press the  softkey to stop replay.
  6. Press the  softkey to replay the waveform from the current frame to the last frame.

---

# To Trigger the Oscilloscope

For triggering, set your trigger conditions according to the requirements, and when a waveform in the waveform stream meets this condition, the oscilloscope captures the waveform and displays it on the screen. The trigger circuit ensures that every acquisition centers around the user-defined trigger condition.

The following is the schematic diagram of the acquisition memory. As shown in the figure below, the position of the trigger event is determined by the reference time point and the delay setting.

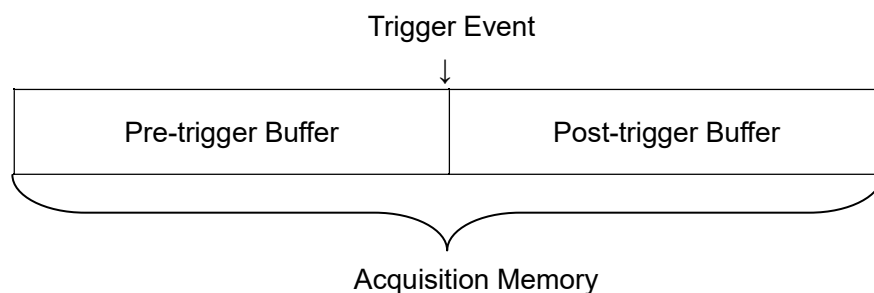

Trigger settings should be based on your requirements and the features of the input signal, thus you need to have some knowledge of the signal under test to quickly capture the desired waveform.

The oscilloscope provides abundant advanced trigger functions which can help you to focus on the desired waveform details. These trigger types are edge, slope, pulse, video, window, interval, dropout, runt, pattern and serial trigger. This chapter will introduce all these trigger functions and tell you how to set the trigger conditions to capture the desired waveform.

---

The contents of this chapter:

- ◆ Trigger Source
- ◆ Trigger Mode
- ◆ Trigger Level
- ◆ Trigger Coupling
- ◆ Trigger Holdoff
- ◆ Noise Rejection
- ◆ Trigger Type
  - Edge Trigger
  - Slope Trigger
  - Pulse Trigger
  - Video Trigger
  - Window Trigger
  - Interval trigger
  - DropOut Trigger
  - Runt Trigger
  - Pattern Trigger

---

## Trigger Source

The 2-channel oscilloscope's trigger source includes analog channels, **EXT**, **EXT/5** and **AC Line**.

The 4-channel oscilloscope's trigger source includes analog channels and **AC Line**.

Press the **Setup** button on the front panel to enter the TRIGGER function menu; press the **Source** softkey and then turn the **Universal Knob** to select the desired trigger source.

The current trigger source is displayed at the upper right corner of the screen. Select a channel with a signal input as the trigger source to obtain a stable trigger.

### Analog channel input:

All signals from the analog channels can all be used as the trigger source, no matter whether the channel selected is enabled, or not.

### External trigger input:

External trigger source can be used to connect an external trigger signal to the EXT TRIG channel if required. The trigger signal (such as an external clock or signal of the circuit to be tested) will be connected to **EXT** and **EXT/5** trigger source via the **[EXT TRIG]** connector. **EXT/5** trigger source attenuates the signal by a factor of 5. It extends the trigger voltage level.

### AC line:

The trigger signal is obtained from the AC power input of the oscilloscope. These kinds of signals can be used to display the relationship between signal (such as an illuminating device) and power (power supply device). For example, it is mainly used in line frequency power related measurements.

Note: Select a stable channel waveform as the trigger source to stabilize the display.



---

## Trigger Mode

The oscilloscope's trigger mode includes auto, normal and single. The Trigger Mode affects the way in which the oscilloscope searches for the trigger.

After the oscilloscope starts running, the oscilloscope operates by first filling the pre-trigger buffer. It starts searching for a trigger after the pre-trigger buffer is filled and continues to flow data through this buffer while it searches for the trigger. While searching for the trigger, the oscilloscope overflows the pre-trigger buffer and the first data put into the buffer is first pushed out (First Input First Out, FIFO).

When a trigger is found, the pre-trigger buffer contains the events that occurred just before the trigger. Then, the oscilloscope fills the post-trigger buffer and displays the acquisition memory.

Press the **Auto**, **Normal** and the **Single** buttons on the front panel to select the desired trigger mode, and the corresponding status light will be lit.

- In the **Auto** trigger mode (the default setting), if the specified trigger conditions are not found, triggers are forced and acquisitions are made so that signal activity is displayed on the oscilloscope.

The **Auto** trigger mode is appropriate when:

- Checking DC signals or signals with unknown levels or activity.
- When trigger conditions occur often enough that forced triggers are unnecessary.

- In the **Normal** trigger mode, triggers and acquisitions only occur when the specified trigger conditions are found. Otherwise, the oscilloscope holds the original waveform and waits for the next trigger.

The **Normal** trigger mode is appropriate when:

- You only want to acquire specific events specified by the trigger settings.
- Triggering on an infrequent signal from a serial bus (for example, I2C, SPI, CAN, LIN, etc.) or another signal that arrives in bursts. The **Normal** trigger mode lets you stabilize the display by preventing the oscilloscope from auto-triggering.

- In the Single trigger mode, the oscilloscope waits for a trigger and displays the waveform when the trigger condition is met and then stops.

The **Single** trigger mode is appropriate:

- To capture single event or a periodic signal.
- To capture burst or other unusual signals.

---

## Trigger Level

Trigger level and slope define the trigger point,

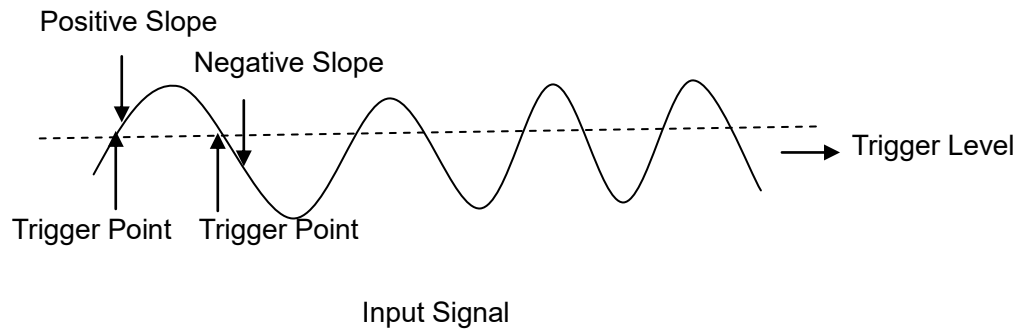

You can adjust the trigger level for a selected analog channel by turning the **Trigger Level Knob**.

You can push the **Trigger Level Knob** to set the level to the waveform's 50% value immediately. If AC coupling is used, pushing the **Trigger Level knob** sets the trigger level to about 0 V.

The position of the trigger level for the analog channel is indicated by the trigger level icon  (if the analog channel is on) at the left side of the display. The value of the analog channel trigger level is displayed in the upper- right corner of the display.

---

## Trigger Coupling

Press the **Setup** button on the front panel to enter the TRIGGER function menu, and then press the **Coupling** softkey and turn the **Universal Knob** or press the **Coupling** softkey continually to select the desired coupling mode.

The oscilloscope provides 4 kinds of trigger coupling modes:

- **DC**: allow DC and AC components into the trigger path.
- **AC**: block all the DC components and attenuate signals lower than 5.8 Hz. Use AC coupling to get a stable edge trigger when your waveform has a large DC offset.
- **LF Reject**: block the DC components and reject the low frequency components lower than 2.08MHz. Low frequency reject removes any unwanted low frequency components from a trigger waveform, such as power line frequencies, etc., that can interfere with proper triggering. Use **LF Reject** coupling to get a stable edge trigger when your waveform has low frequency noise.
- **HF Reject**: reject the high frequency components higher 1.27MHz)

Note: trigger coupling has nothing to do with the channel coupling.

---

## Trigger Holdoff

Trigger holdoff can be used to stabilise the trigger on complex waveforms (such as pulse streams or burst waveforms). Holdoff by time is the amount of time that the oscilloscope waits before re-arming the trigger circuitry. The oscilloscope will not trigger until the holdoff time expires.

Use the holdoff to trigger on repetitive waveforms that have multiple edges (or other events) between waveform repetitions. You can also use holdoff to trigger on the first edge of a burst when you know the minimum time between bursts.

For example, to get a stable trigger on the repetitive pulse burst shown below, set the holdoff time to be  $>200$  ns but  $<600$  ns.

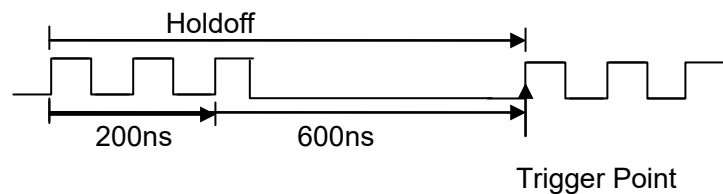

The correct holdoff setting is typically slightly less than one repetition of the waveform. Set the holdoff to this time to generate a unique trigger point for a repetitive waveform. Only edge trigger and serial trigger have holdoff option. The holdoff time of the oscilloscope is adjustable from 100ns to 1.5s.

1. Press the **Stop** button, and then use the **Horizontal Position Knob** and the **Horizontal Scale Knob** to find where the waveform repeats. Measure this time using cursors; then, set the holdoff.
2. Press the **Setup** button on the front panel to enter the TRIGGER function menu. The default trigger type is edge.
3. Press the **Holdoff Close** softkey; and then turn the **Universal Knob** to set the desired holdoff time.

Note: adjust the time scale and horizontal position will not affect the holdoff time.

---

## Noise Rejection

Noise Reject adds additional hysteresis to the trigger circuitry. By increasing the trigger hysteresis band, you reduce the possibility of triggering on noise. However, this also decreases the trigger sensitivity so that a slightly larger signal is required to trigger the oscilloscope.

Press the **Setup** button on the front panel, and then press the **Noise Reject** softkey continually to set the option to **On** or **Off** to turn on or off the noise rejection function.

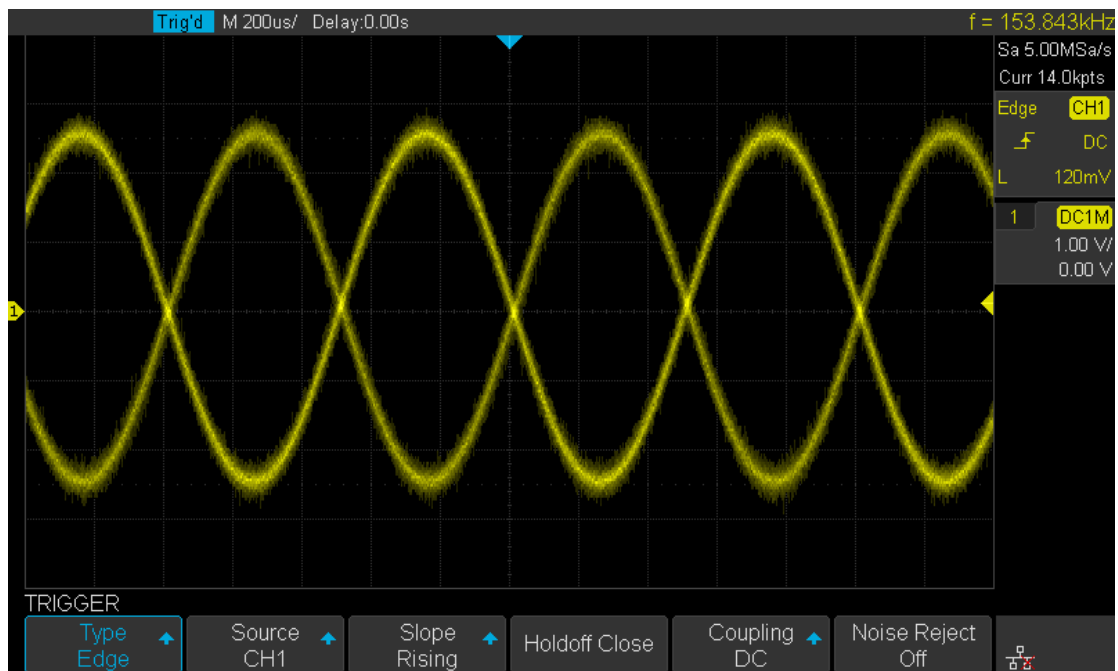

Figure 25 Turn off the Noise Reject



Figure 26 Turn on the Noise Reject

If the signal you are probing is noisy, you can set up the oscilloscope to reduce the noise in the trigger path and on the displayed waveform. First, stabilize the displayed waveform by removing the noise from the trigger path. Second, reduce the noise on the displayed waveform.

1. Connect a signal to the oscilloscope and obtain a stable display.
2. Remove the noise from the trigger path by setting trigger coupling to **LF Reject**, **HF Reject** or turning on **Noise Reject**.
3. Set the **Acquisition** option to Average to reduce noise on the displayed waveform.

---

## Trigger Type

The oscilloscope provides abundant advanced trigger functions, including various serial bus triggers.

- ◆ Edge trigger
- ◆ Slope trigger
- ◆ Pulse trigger
- ◆ Video trigger
- ◆ Window trigger
- ◆ Interval trigger
- ◆ DropOut trigger
- ◆ Runt trigger
- ◆ Pattern trigger

## Edge Trigger

Edge trigger distinguishes the trigger points by seeking the specified edge (rising, falling, rising & falling) and trigger level.

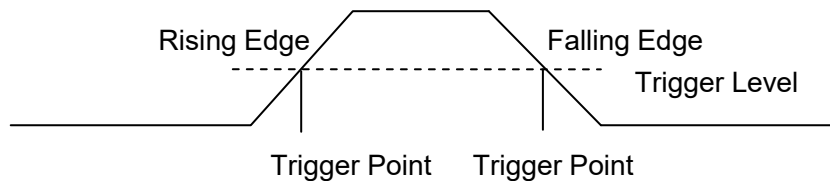

1. Press the **Setup** button on the front panel to enter the TRIGGER system function menu.
2. Press the **Type** softkey; turn the **Universal Knob** to set select **Edge** and then push the knob to confirm.
3. Press the **Source** softkey; turn the **Universal Knob** to select the desired trigger source.
4. Press the **Slope** softkey; turn the **Universal Knob** to select the desired trigger edge (rising, falling or rising & falling), and then press down the knob to confirm. The current trigger slope is displayed at the upper right corner of the screen.
5. Turn the **Trigger Level Knob** to adjust the trigger level to obtain stable trigger.

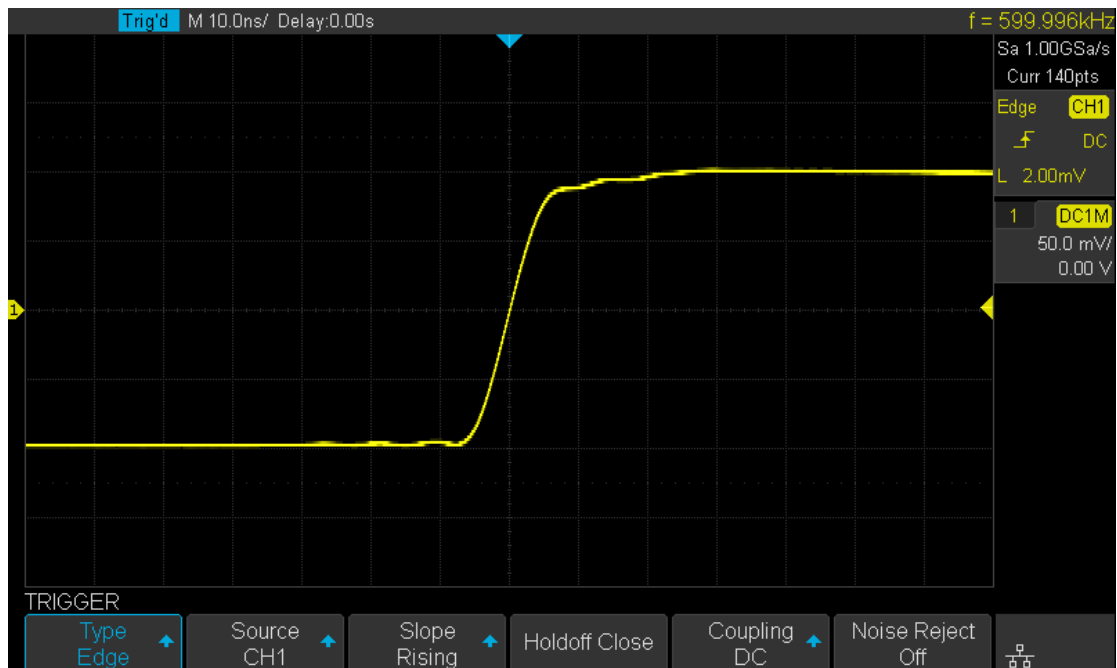

Figure 27 Edge Trigger

Note: Press the **Auto Setup** button will set the trigger type to Edge and slope to rising.



---

## Slope Trigger

The slope trigger looks for a rising or falling transition from one level to another level in greater than or less than a certain amount of time.

In the oscilloscope, positive slope time is defined as the time difference between the two crossing points of trigger level line A and B with the positive edge as shown in the figure below.

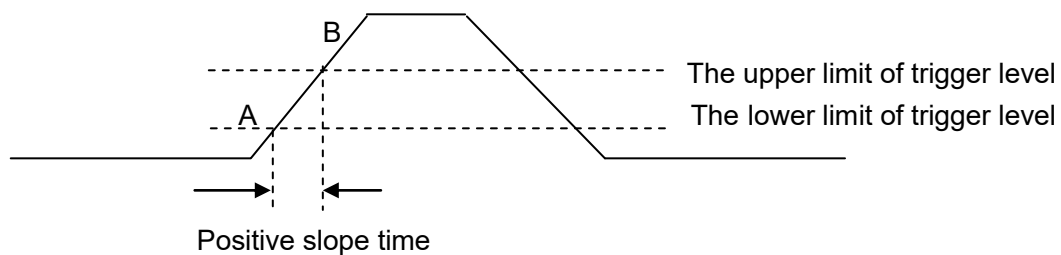

1. Press the **Setup** button on the front panel to enter the TRIGGER function menu.
2. Press the **Type** softkey; turn the **Universal Knob** to set select **Slop** and then push the knob to confirm.
3. Press the **Source** softkey; turn the **Universal Knob** to select CH1 or CH2 as the trigger source.
4. Press the Slop softkey; turn the **Universal Knob** to set select the desired trigger edge (rising or falling), and then push down the knob to confirm. The current trigger slope is displayed at the upper right corner of the screen.
5. Press **Lower Upper** softkey to select the **Lower** or **Upper** trigger level; then turn the **Trigger Level Knob** to adjust the position. The trigger level values are displayed at the upper right corner of the screen.

The lower trigger level cannot be higher than the upper trigger level. In the trigger state message box, L1 means the upper trigger lever while L2 means the lower trigger level.

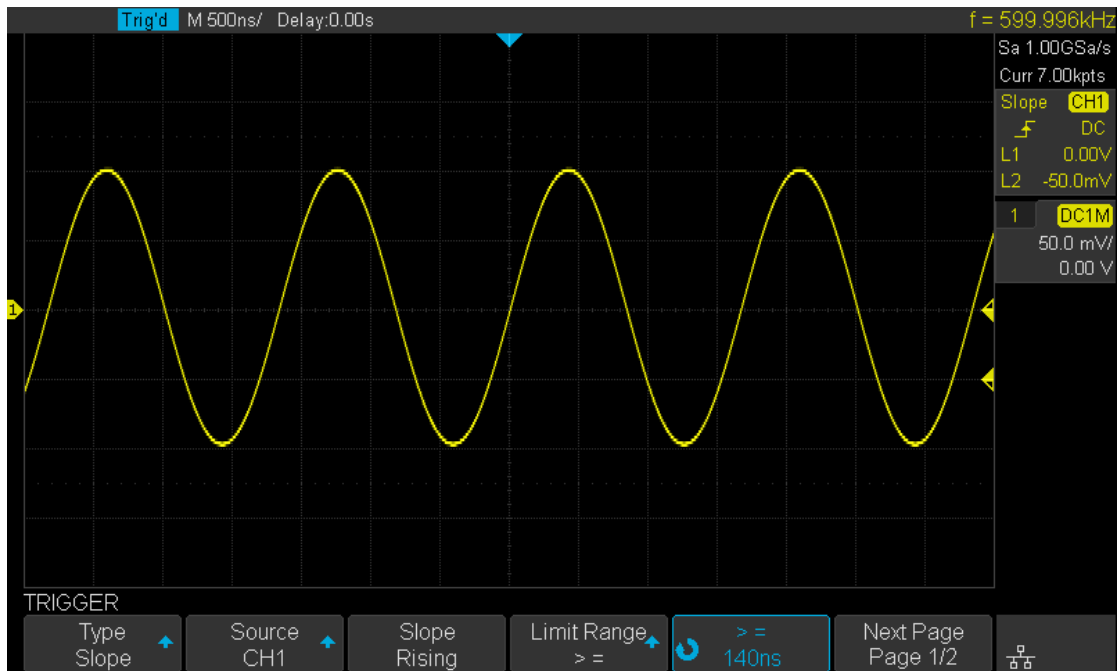

Figure 28 Slope Trigger

6. Press the **Limit Range** softkey; then turn the **Universal Knob** to select the desired slope condition, and push down the knob to confirm.
  - **<=** (less than a time value): trigger when the positive or negative slope time of the input signal is lower than the specified time value.
  - **>=** (greater than a time value): trigger when the positive or negative slope time of the input signal is greater than the specified time value.
  - **[--,--]** (within a range of time value): trigger when the positive or negative slope time of the input signal is greater than the specified lower limit of time and lower than the specified upper limit of time.
  - **--][--** (outside a range of time value): trigger when the positive or negative slope time of the input signal is greater than the specified upper limit of time or lower than the specified lower limit of time.

---

## Pulse Trigger

Trigger on the positive or negative pulse with a specified width.

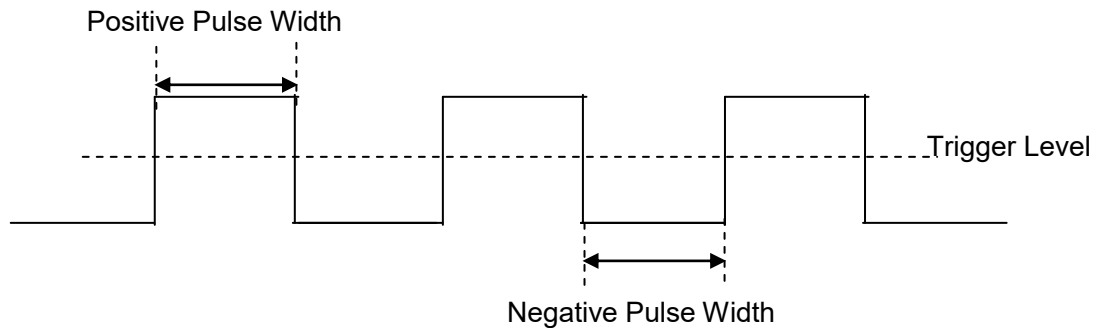

1. Press the **Setup** button on the front panel to enter the TRIGGER function menu.
2. Press the **Type** softkey; turn the **Universal Knob** to select **Pulse** and then push the knob to confirm.
3. Press the **Source** softkey; turn the **Universal Knob** to select CH1 or CH2 as the trigger source.
4. Turn the **Trigger Level Knob** to adjust the trigger level to the desired place.
5. Press the **Polarity** softkey to select **Positive** or **Negative** pulse to trigger on. The current trigger polarity is displayed at the upper right corner of the screen.
6. Press the **Limit Range** softkey; turn the **Universal Knob** to select the desired condition.
  - **<=** (less than a time value): trigger when the positive or negative pulse time of the input signal is lower than the specified time value.  
For example, for a positive pulse, if you set  $t$  (pulse real width)  $< 100\text{ns}$ , the waveform will trigger according to the diagram below.



- **>=** (greater than a time value): trigger when the positive or negative pulse time of the input signal is greater than the specified time value.  
For example, for a positive pulse, if you set  $t$  (pulse real width)  $> 100\text{ns}$ , the waveform will trigger according to the diagram below.



- **[--,--]** (within a range of time value): trigger when the positive or negative pulse time of the input signal is greater than the specified lower limit of time and lower than the specified upper limit of time value.  
For example, for a positive pulse, if you set t (pulse real width) >100ns and <300ns, the waveform will trigger on the 200ns pulse.

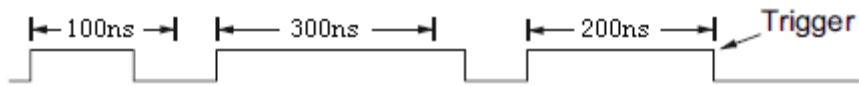

- **--][--** (outside a range of time value): trigger when the positive or negative pulse time of the input signal is greater than the specified upper limit of time and lower than the specified lower limit of time value.

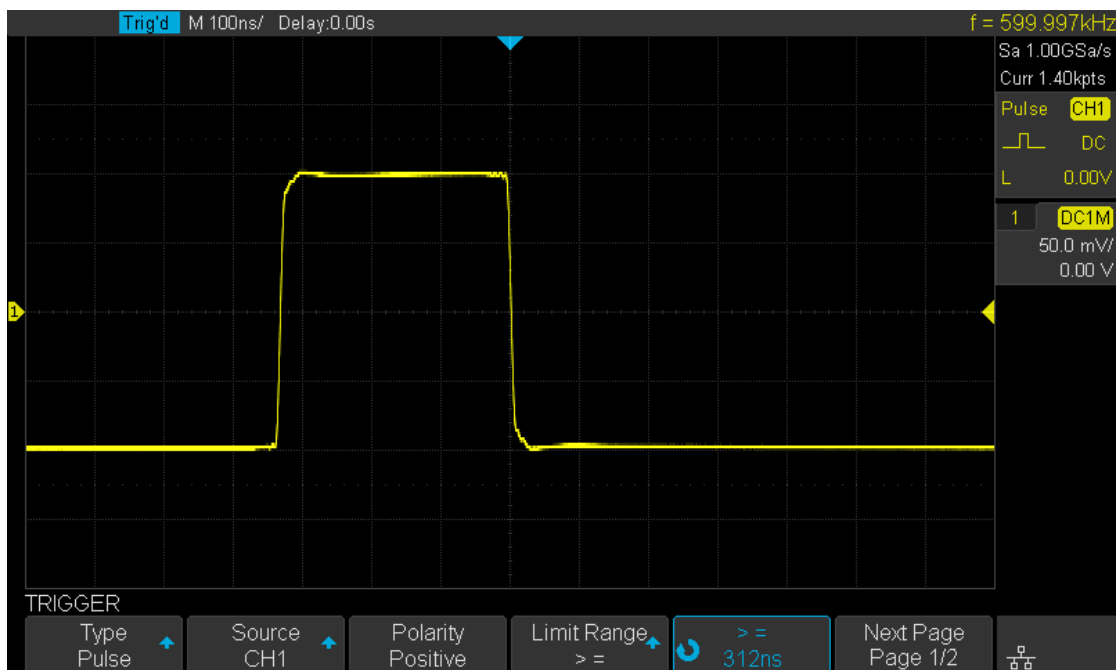

Figure 29 Pulse Trigger

---

## Video Trigger

Video triggering can be used to capture the complex waveforms of most standard analog video signals. The trigger circuitry detects the vertical and horizontal interval of the waveform and produces triggers based on the video trigger settings you have selected. The oscilloscope supports standard video signal field or line of NTSC (National Television Standards Committee), PAL (Phase Alternating Line) HDTV (High Definition Television) and custom video signal trigger.

1. Press the **Setup** button on the front panel to enter the TRIGGER function menu.
2. Press the **Type** softkey; then turn the **Universal Knob** to select **Video** and push down the knob to confirm.
3. Press the **Source** softkey; turn the **Universal Knob** to select CH1 or CH2 as the trigger source. Turning the **Trigger Level Knob** does not change the trigger level because the trigger level is automatically set to the sync pulse.
4. Press the **Standard** softkey to select the desired video standard. The oscilloscope supports the following video standards.

Standard	Type	Sync Pulse
NTSC	Interlaced	BI-level
PAL	Interlaced	BI-level
HDTV 720P/50	Progressive	Tri-level
HDTV 720P/60	Progressive	Tri-level
HDTV 1080P/50	Progressive	Tri-level
HDTV 1080P/60	Progressive	Tri-level
HDTV 1080i/50	Progressive	Tri-level
HDTV 1080i/50	Progressive	Tri-level
Custom		

The table below shows the parameters of the Custom video trigger.

Frame Rate	25Hz, 30Hz, 50Hz, 60Hz	
Of Lines	300~2000	
Of Fields	1, 2, 3, 4	
Interlace	1:1, 2:1, 4:1, 8:1	
Trigger Position	Line	Field
	(line value)/1	1
	(line value)/2	2
	(line value)/3	3
	(line value)/4	4
	(line value)/5	5
	(line value)/6	6
	(line value)/7	7
	(line value)/8	8

The table below takes **Of Lines** as 800 as an example to explain the relation between **Of Lines, Of Fields, Interlace, Trigger Line** and **Trigger Field**.

Of Lines	Of Fields	Interlace	Trigger Line	Trigger Field
800	1	1:1	800	1
800	1,2,4 or 8	2:1	400	1, 1~2, 1~4, 1~8
800	1,2,4 or 8	4:1	200	1, 1~2, 1~4, 1~8
800	1,2,4 or 8	8:1	100	1, 1~2, 1~4, 1~8

- Press the **Sync** softkey to select **Any** or **Select** trigger mode.
  - Any**: trigger on any of the horizontal sync pulses
  - Select**: trigger on the appointed line and field you have set. Press the Line or Field softkey; then turn the **Universal Knob** to set the value.

The following table lists the line numbers per field for each video standard.

Standard	Field 1	Field 2
NTSC	1 to 262	1 to 263
PAL	1 to 312	1 to 313
HDTV 720P/50, HDTV 720P/60	1 to 750	
HDTV 1080P/50, HDTV 1080P/60	1 to 1125	
HDTV 1080iP/50, HDTV 1080i/60	1 to 562	1 to 563

The following are exercises to familiarize you with video triggering.

- To trigger on a specific line of video
- To use Custom video trigger

### To Trigger on a Specific Line of Video

Video triggering requires greater than 1/2 division of sync amplitude with any analog channel as the trigger source.

The example below set to trigger on field 2, line 124 using the NTSC video standard.

- Press the **Setup** button on the front panel to enter the TRIGGER system function menu.
- Press the **Type** softkey; then use the **Universal Knob** to select Video and push down the knob to confirm.
- Press the **Source** softkey; turn the Universal Knob to select CH1 as the trigger source, and press the knob to confirm.
- Press the **Standard** softkey; turn the Universal Knob to select NTSC, and press the knob to confirm.
- Press the **Sync** softkey and set the option to **Select**; press the **Line** softkey and then turn the universal to select **022** and push the knob to confirm; press the **Field** softkey and then turn the **Universal Knob** to select **1** and push the knob to confirm.

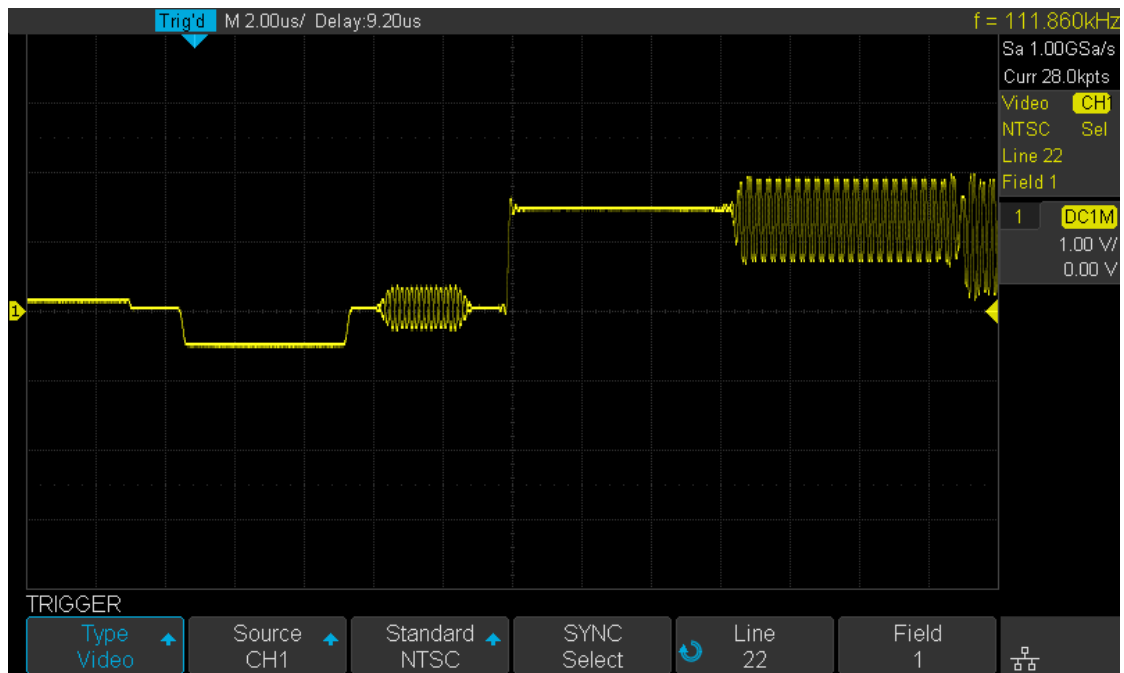

Figure 30 Video Trigger

### To Use Custom Video Trigger

Custom video trigger supports frame rate of 25Hz, 30Hz, 50Hz and 60Hz, and the line range is available from 300 to 2000. The steps below show how to set custom trigger.

1. Press the **Setup** button on the front panel to enter the TRIGGER function menu.
2. Press the **Type** softkey; then use the **Universal Knob** to select **Video** and push down the knob to confirm.
3. Press the **Source** softkey; turn the **Universal Knob** to select **CH1** as the trigger source, and push down the knob to confirm.
4. Press the **Standard** softkey; turn the **Universal Knob** to select **Custom**, and push down the knob to confirm.
5. Press the **Setting** softkey to enter the custom setting function menu. Press the **Interlace** softkey; turn the **Universal Knob** to select the desired value.
6. Press the **Of Field** softkey; turn the **Universal Knob** to select the desired value.
7. Press the **Sync** softkey to enter the TRIG ON menu to set the line and field.
  - Press the Type softkey to select **Select** or **Any**.
  - If the **Type** option set to **Select**, press the Line softkey; turn the **Universal Knob** to select the desired value. Press the **Field** softkey; turn the **Universal Knob** to select the desired value.

---

## Window Trigger

Window trigger provides a high trigger level and a low trigger level. The instrument triggers when the input signal passes through the high trigger level or the low trigger level.

There are two kinds of window types: Absolute and Relative. They have different trigger level adjustment methods. Under Absolute window type, the lower and the upper trigger levels can be adjusted respectively via the Level knob; under Relative window type, adjust the Center value to set the window center; adjust the Delta value to set the window range, the lower and the upper trigger levels always move together.

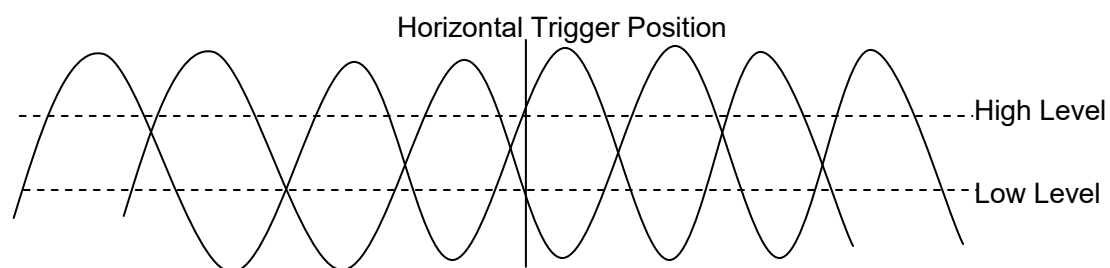

- If the lower and the upper trigger levels are both within the waveform amplitude range, the oscilloscope will trigger on both rising and falling edge.
- If the upper trigger level is within the waveform amplitude range while the lower trigger level is out of the waveform amplitude range, the oscilloscope will trigger on rising edge only.
- If the lower trigger level is within the waveform amplitude range while the upper trigger level is out of the waveform amplitude range, the oscilloscope will trigger on falling edge only.

### To set window trigger via Absolute window type:

1. Press the **Setup** button on the front panel to enter the TRIGGER function menu.
2. Press the **Type** softkey; then use the **Universal Knob** to select **Window** and push down the knob to confirm.
3. Press the **Source** softkey; turn the **Universal Knob** to select CH1 or CH2 as the trigger source.
4. Press the Window **Type** softkey to select Absolute.
5. Press the **Lower Upper** softkey to select **Lower** or **Upper** trigger level; then turn the **Trigger Level Knob** to adjust the position. The trigger level values are displayed at the upper right corner of the screen.

The Lower trigger level cannot be higher than the upper trigger level. In the trigger state message box, **L1** means the upper trigger level while **L2** means the lower trigger level.



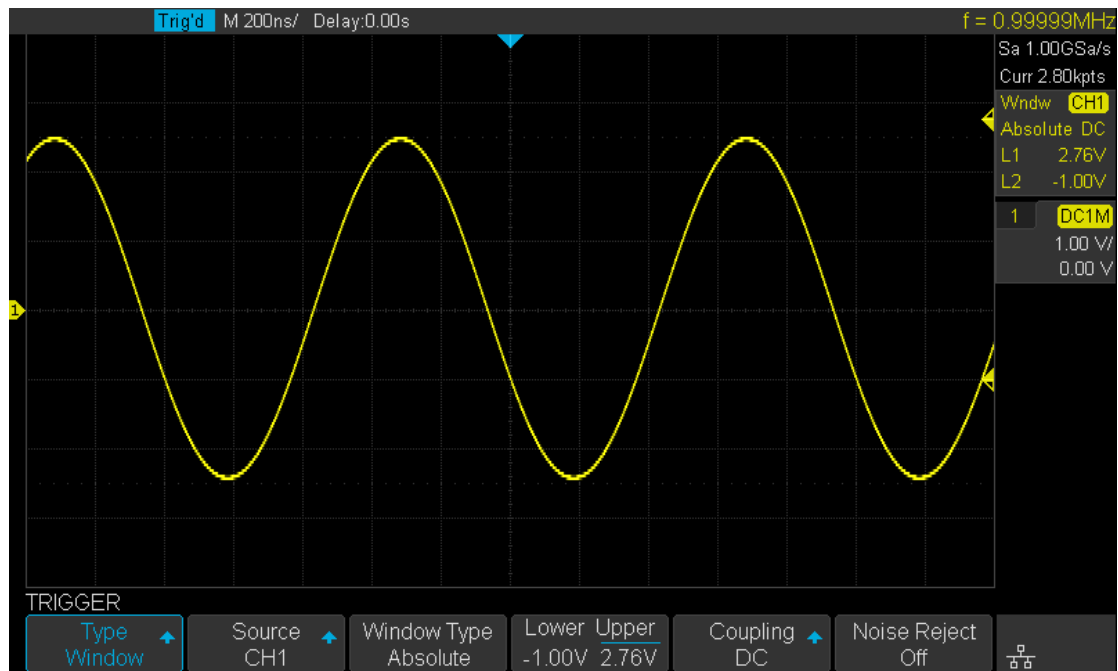

Figure 31 Absolute Window Trigger

**To set window trigger via Relative window type:**

1. Press the **Setup** button on the front panel to enter the TRIGGER system function menu.
2. Press the **Type** softkey; then use the **Universal Knob** to select **Window** and push down the knob to confirm.
3. Press the **Source** softkey; turn the **Universal Knob** to select CH1 or CH2 as the trigger source.
4. Press the **Window Type** softkey to select **Relative**.
5. Press the **Center Delta** softkey to select **Center** or **Delta** trigger level mode; then turn the **Trigger Level Knob** to adjust the position. The **Center** and **Delta** values are displayed at the upper right corner of the screen.

In the trigger state message box, **C** means **Center**, the center value of the lower and upper trigger levels; **D** means **Delta**, the difference between the lower (or upper) trigger level and the trigger level center.

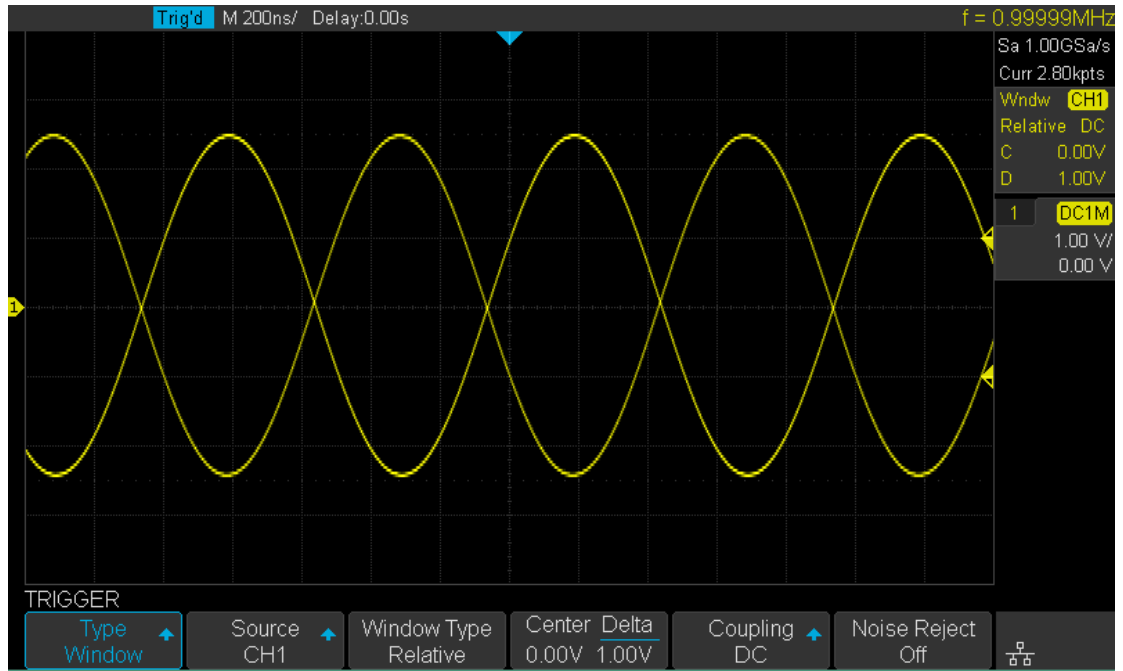
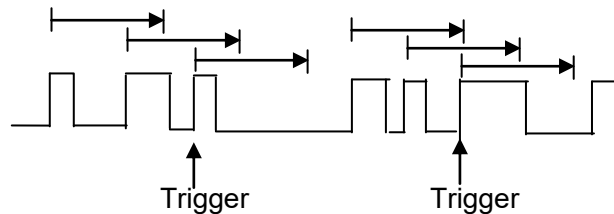

Figure 32 Relative Window Trigger

---

## Interval Trigger

Trigger when the times difference between adjacent rising or falling edges meets the time limit ( $\leq$ ,  $\geq$ , [--,--], --][--).



To set interval trigger:

1. Press the **Setup** button on the front panel to enter the TRIGGER system function menu.
2. Press the **Type** softkey; then use the **Universal Knob** to select **Interval** and push down the knob to confirm.
3. Press the **Source** softkey; turn the **Universal Knob** to select CH1 or CH2 as the trigger source.
4. Press the **Slope** softkey to select rising or falling edge.
5. Press the **Limit Range** softkey; turn the **Universal Knob** to select desired condition.
  - $\leq$  (less than a time value): trigger when the positive or negative pulse time of the input signal is lower than the specified time value.
  - $\geq$  (greater than a time value): trigger when the positive or negative pulse time of the input signal is greater than the specified time value.
  - [--,--] (within a range of time value): trigger when the positive or negative pulse time of the input signal is greater than the specified lower limit of time and lower than the specified upper limit of time.
  - --][-- (outside a range of time value): trigger when the positive or negative pulse time of the input signal is greater than the specified upper limit of time or lower than the specified lower limit of time value.
6. Press the **Time Setting** softkey ( $\leq$ ,  $\geq$ , [--,--],--][--), turn the **Universal Knob** to select the desired value.

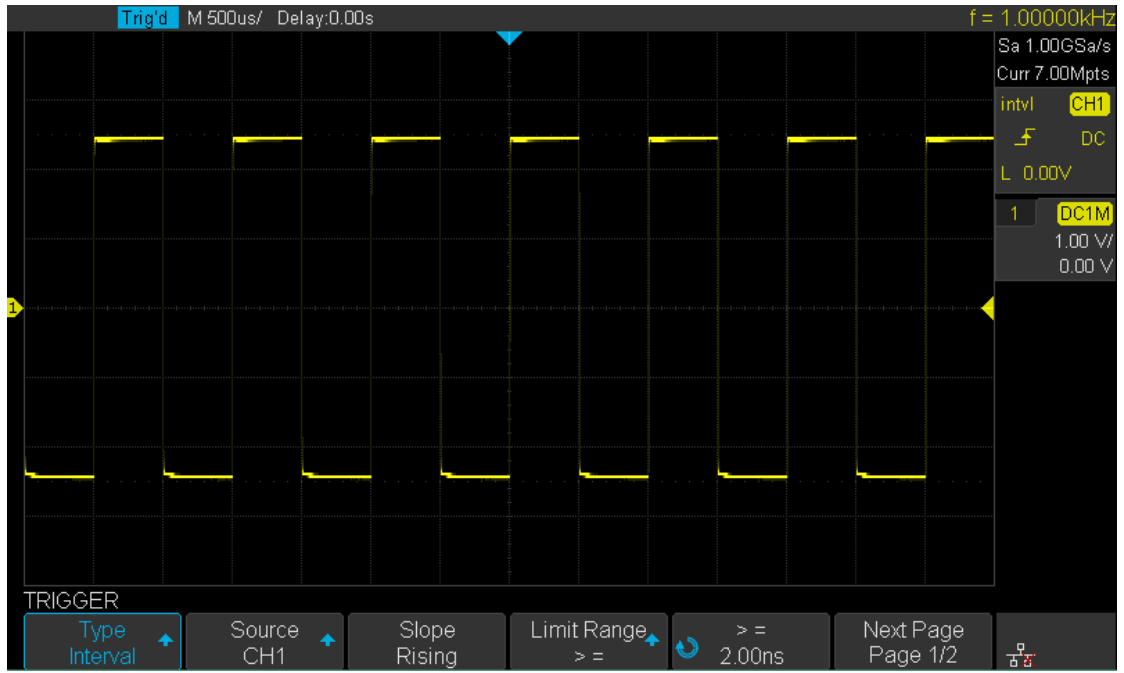

Figure 33 Interval Trigger

---

## DropOut Trigger

DropOut trigger includes two types: edge and state.

### Edge

Trigger when the time interval ( $\Delta T$ ) from when the rising edge (or falling edge) of the input signal passes through the trigger level to when the adjacent rising edge (or falling edge) passes through the trigger level is greater than the timeout time set, as shown in the figure below.

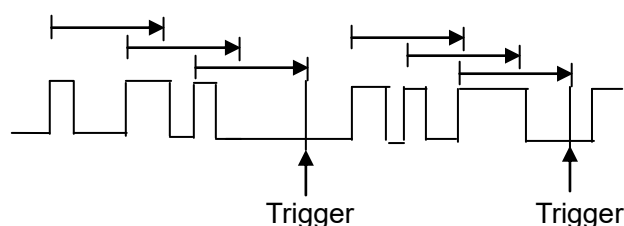

### State

Trigger when the time interval ( $\Delta T$ ) from when the rising edge (or falling edge) of the input signal passes through the trigger level to when the adjacent falling edge (or rising edge) passes through the trigger level is greater than the timeout time set, as shown in the figure below.

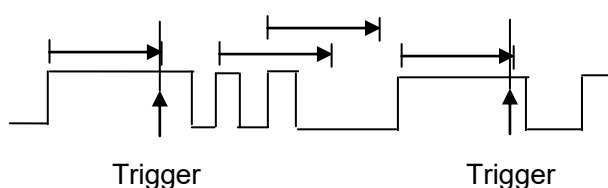

To set edge DropOut trigger:

1. Press the **Setup** button on the front panel to enter the TRIGGER system function menu.
2. Press the **Type** softkey; then use the **Universal Knob** to select **DropOut** and push down the knob to confirm.
3. Press the **Source** softkey; turn the **Universal Knob** to select CH1 or CH2 as the trigger source. The current trigger source is displayed at the upper right corner of the screen. Select channel with signal input as trigger source to obtain stable trigger.
4. Press the **Slope** softkey to select rising or falling edge.
5. Press the **OverTime Type** softkey to select **Edge**.
6. Press the **Time** softkey; turn the universal to select the desired value.

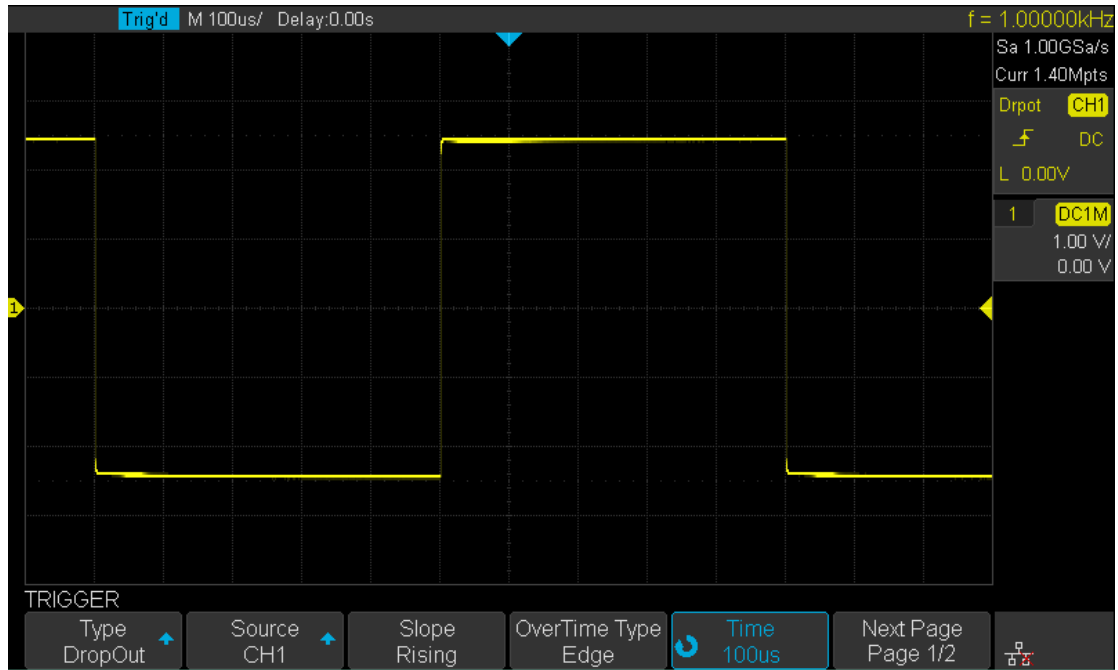

Figure 34 Edge DropOut Trigger

To set state DropOut trigger:

1. Press the **Setup** button to enter the TRIGGER system function menu.
2. Press the **Type** softkey; then turn the **Universal Knob** to select **DropOut** and push down the knob to confirm.
3. Press the **Source** softkey; turn the **Universal Knob** to select CH1 or CH2 as the trigger source.
4. Press the **Slope** softkey to select rising or falling edge.
5. Press the **OverTime** Type softkey to select State.
6. Press the **Time** softkey; turn the **Universal Knob** to select the desired value.

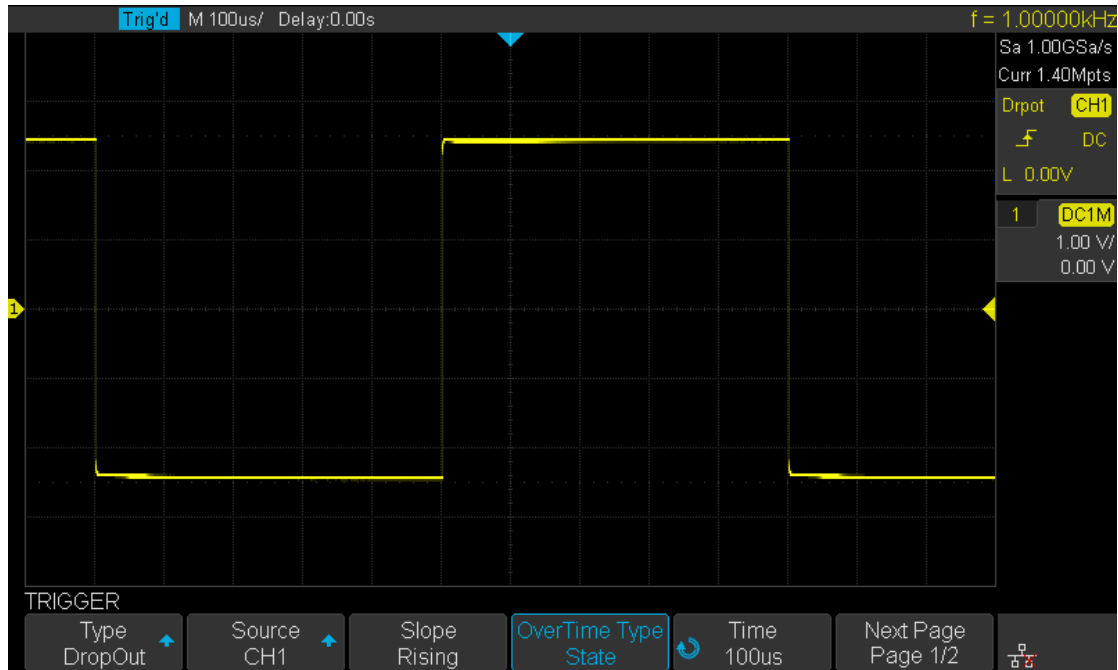
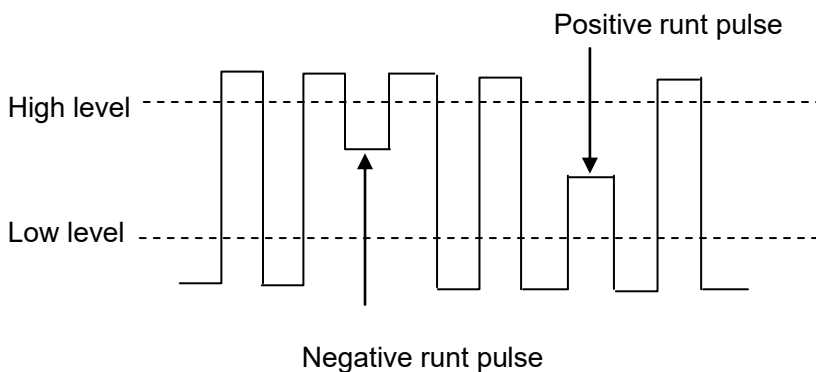

Figure 35 State DropOut Trigger

## Runt Trigger

The Runt trigger looks for pulses that cross one threshold but not another as shown in the picture below.



- A positive runt pulse crosses through a lower threshold but not an upper threshold.
- A negative runt pulse crosses through an upper threshold but not a lower threshold.

To trigger on runt pulse:

1. Press the **Setup** button on the front panel to enter the **TRIGGER** system function menu.
2. Press the **Type** softkey; then turn the **Universal Knob** to select **DropOut** and push down the knob to confirm.
3. Press the **Source** softkey; turn the **Universal Knob** to select CH1 or CH2 as the trigger source.
4. Press the **Polarity** softkey to select **Positive** or **Negative** pulse to trigger.

5. Press the **Limit Range** softkey; turn the **Universal Knob** to select the desired condition ( $\leq$ ,  $\geq$ ,  $[-, -]$  or  $-[-]$ ).
6. Press the **Time Setting** softkey, and then turn the **Universal Knob** to select the desired value.
7. Press the **Next Page** softkey to enter the second page of the TRIGGER system function menu. Press the **Lower Upper** softkey to select **Lower** or **Upper** trigger level, and then turn the **Universal Knob** to set the position.

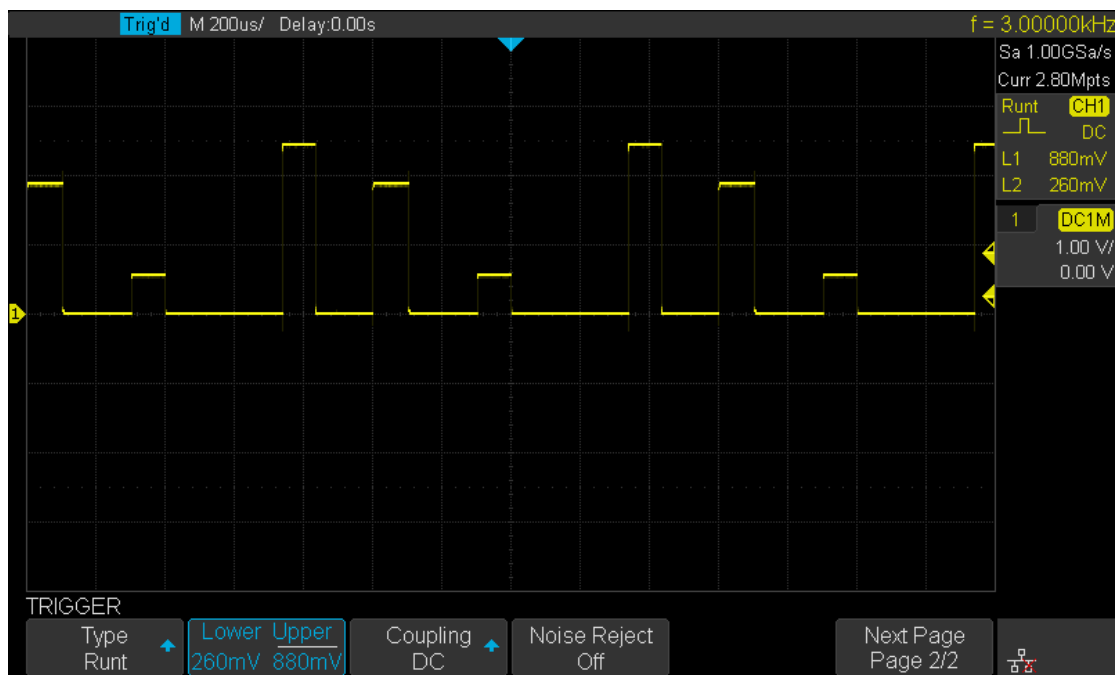

Figure 36 Runt Trigger



---

## Pattern Trigger

The Pattern trigger identifies a trigger condition by looking for a specified pattern. The pattern trigger can be expanded to incorporate delays similar to other triggers. Pattern durations are evaluated using a timer. The timer starts on the last edge that makes the pattern “true”. Potential triggers occur on the first edge that makes the pattern false, provided that the time qualifier criterion has been met. The oscilloscope provides 4 patterns: logical AND, OR, NAND and NOR combination of the channels. Each channel can be set to low, high or invalid.

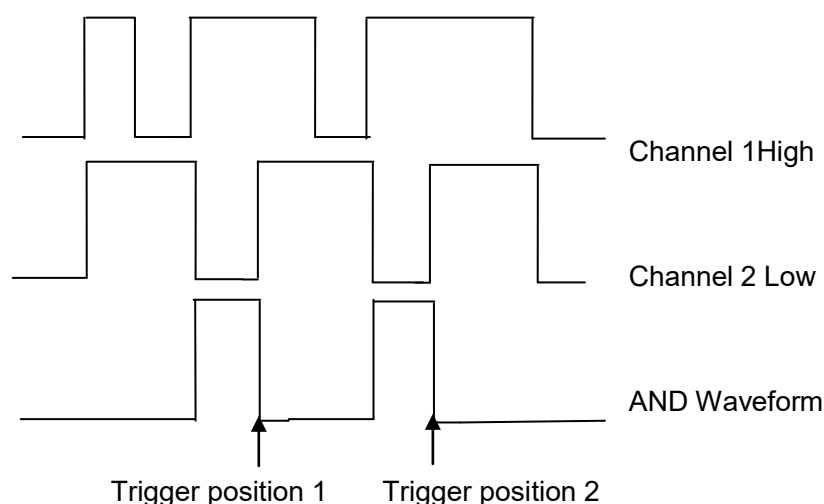

Do the following steps to set pattern trigger:

1. Press the **Setup** button on the front panel to enter the TRIGGER function menu.
2. Press the **Type** softkey; turn the **Universal Knob** to select Pattern, and then push down the knob to confirm.
3. Press each channel softkey to select **Invalid**, **High** or **Low**.
  - **Low** sets the pattern to low on the selected channel. A low is a voltage level that is less than the channel's trigger level or threshold level.
  - **High** sets the pattern to high on the selected channel. A high is a voltage level that is greater than the channel's trigger level or threshold level.
  - **Invalid** sets the pattern to don't care on the selected channel. Any channel set to don't care is ignored and is not used as part of the pattern.However, if all channels in the pattern are set to **Invalid**, the oscilloscope will not trigger.  
Adjust the trigger level for the selected analog channel by turning the Trigger Level knob. **Invalid** doesn't need to set a trigger level.
4. Press the **Next Page** softkey to enter the second page of the pattern trigger menu.
5. Press the **Logic** softkey and then turn the **Universal Knob** to select the desired logic combination **AND**, **OR**, **NAND** or **NOR**.
6. Press the **Time** softkey; then turn the **Universal Knob** to select the desired time value.
7. Press the **Holdoff Close** softkey to turn on the Holdoff function; then turn the

**Universal Knob** to select the desired value.

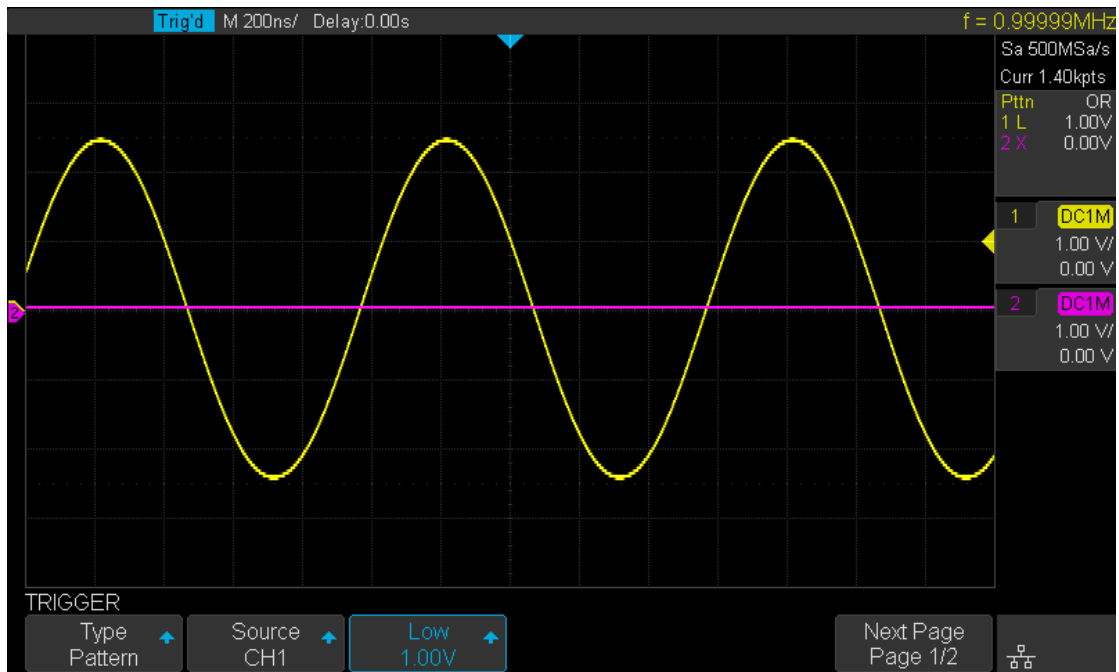

Figure 37 Pattern Trigger

---

# Serial trigger and decode

The oscilloscope provides I2C, SPI, UART/RS232, CAN and LIN serial trigger and decode. This chapter introduces the method of triggering and decoding these serial signals in detail.

The contents of this chapter:

- ◆ I2C Trigger and Decoder
- ◆ SPI Trigger and Decoder
- ◆ UART/RS232 Trigger and Decoder
- ◆ CAN Trigger and Decoder
- ◆ LIN Trigger and Decoder

---

## I2C Trigger and Serial Decode

Three simple steps are necessary to trigger and decode the signals: “**Setup for I2C Signals**”, “**I2C Triggering**” and “**I2C Decode**”.

### Setup for I2C Signals

Setting the I2C (Inter-IC bus) signal includes two steps: connecting the serial data signal (SDA) and serial clock signal (SCK) to the oscilloscope, specifying the threshold voltage of each input signal.

1. Press **Decode** key to enter the **DECODE** function menu as Figure 38 shows.



Figure 38 I2C DECODE Menu

2. Press the **Decode** softkey and select the desired decoder (Decode1 or Decode2).
3. Press **Protocol** softkey and then select **I2C** by turning Universal Knob.
4. Press **Signal** softkey to enter the **SIGNAL** menu as Figure 39 shows.



Figure 39 I2C SIGNAL Menu

5. Set SCL (I2C's clock signal):
  - a. Press **SCL** softkey to select the channel that is connected to the I2C clock signal.
  - b. Press **Threshold** softkey to set the I2C clock signal's threshold voltage level Using the Universal Knob. The threshold voltage level is required for decoding, and it will be used as the trigger voltage level when setting the trigger type to serial.
6. Set SDA (I2C's data signal):
  - a. Press **SDA** to select the channel that is connected to the I2C data signal.
  - b. Press second **Threshold** softkey to set the I2C data signal's threshold voltage level using the Universal Knob. The threshold voltage level is for decoding,

---

and it will be used as the trigger voltage level when setting the trigger type to serial.

(Tips: SDA should be stable during the whole high clock cycle, otherwise it will be interpreted as a start or stop condition (data transitioning while the clock is high).)

7. Press  softkey to return to the previous menu.

---

## I2C Triggering

This part introduces the nine trigger conditions (Start, Stop, Restart, No Ack, EEPROM, 7 Bit Addr & Data, 10 Bit Addr & Data and Data Length) and the methods of setting them.

### Introduction to the trigger conditions

- **Start Condition**— the oscilloscope will be triggered when the SDA signal transitions from a high to a low while the SCL clock is high. If it is the trigger condition (including frame triggers), a restart will be treated as a “Start condition”.
- **Stop Condition**— the oscilloscope will be triggered when SDA transitions from low to high while the SCL is high.

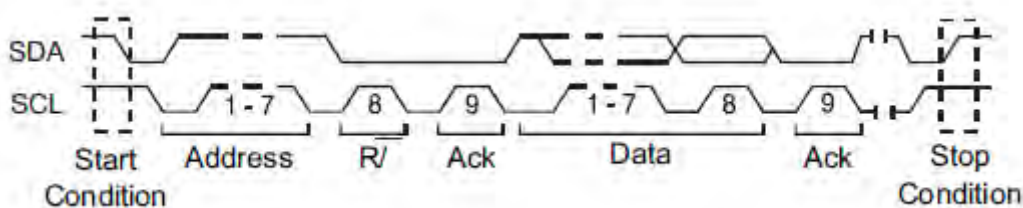

- **Restart**— the oscilloscope will be triggered when another “Start condition” occurs before a “Stop condition”.
- **No Ack**— the oscilloscope will be triggered when SDA data is high during any SCL’s ACK bit.
- **EEPROM** — the trigger searches for EEPROM control byte (the value is 1010xxx) on the SDA bus. And there is a Read bit and a ACK bit following EEPROM. Using **Limit Range** softkey to set the qualifier and **Data1** softkey to set the data’s value. If EEPROM’s data is greater(less, equal) than Data1, the oscilloscope will be triggered at the edge of ACK bit behind Data byte. It’s unnecessary that the Data byte must follow the EEPROM.

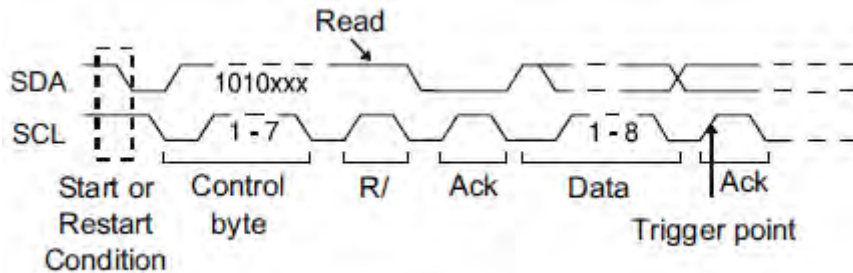

Read

- **7 Bit Address & Data** — the oscilloscope will be triggered when the following conditions are satisfied.
  - The address's length must be 7 bits and the address's value is the same as the address trigger value.
  - If you have set either Data1's or Data2's value, and the signal has data that is the same as that value. If you have set both Data1's and Data2's value, the signal should have two consecutive data values, the first data value is Data1, second data value is Data2.

(**Note:** If the data value is 0xXX, any data value will be matched)

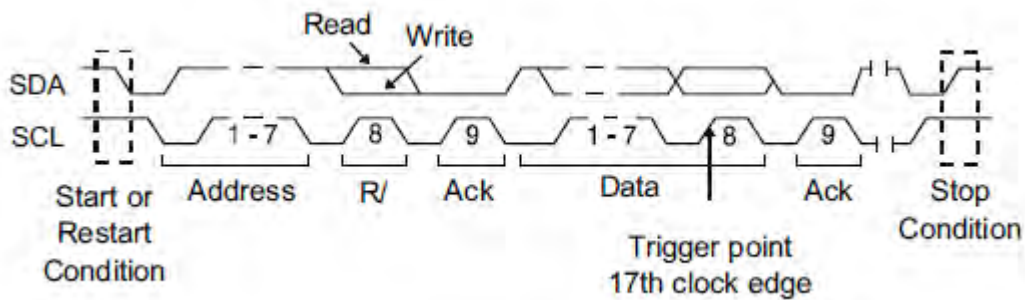

On the 17th Clock Edge

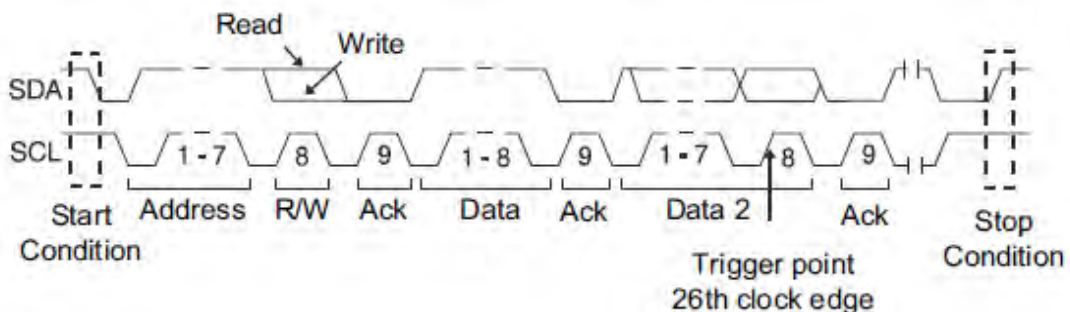

On the 26th Clock Edge

- **10 Bit Address & Data** — the oscilloscope will be triggered when the following conditions are satisfied.
  - The address's length must be 10 bits and the address's value is the same as the address set value.
  - If you have set either Data1's or Data2's value, and the signal has data that is the same as those values in that order.

(**Note:** If the set value is 0xXX, any data value will be matched)

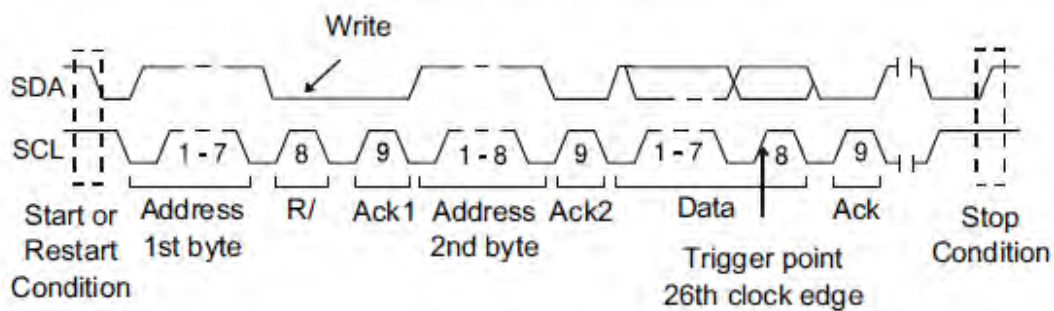

Write

- **Data Length** — When SDA data's length is equal to the value of Byte Length and address's length is the same as the set value, the oscilloscope will be triggered. Byte length is in the range of 1 to 12 bits.

### Operation steps:

1. Press **Setup** to enter the **TRIGGER** function menu.
2. Press **Type** and select **Serial**.
3. Press **Protocol** and select **I2C**.
4. Press **Trigger Setting** softkey.



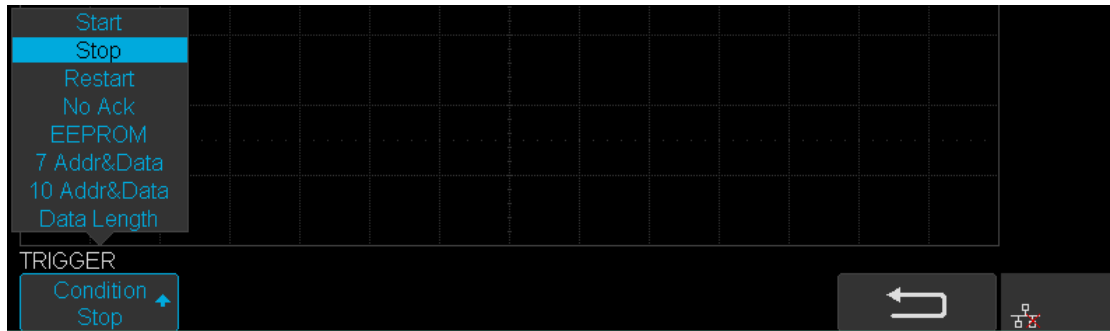

Figure 40 I2C TRIGGER Menu

5. Press the **Condition** softkey and turn the Universal Knob to select the trigger condition:

- If you select the **EEPROM** condition:
  - a. Press the **Limit Range** softkey to set the qualifier ( = , < or >).
  - b. Press **Data1** softkey and set its value by turning the Universal Knob.
- If you select **7 Addr & Data** or **10 Addr & Data** condition:
  - a. Press the **Addr** softkey and turn the Universal Knob to select the 7- bit or 10-bit device address.
  - b. Press the **Data1** or **Data2** softkey and set the value of them.
  - c. Press The **R/W bit** softkey and select write-frame or read-frame to trigger the oscilloscope.

(**Tips:** If device address is 7-bit, the value of the address is in the range of 0x00 to 0x7F. If the device address is 10-bit, the value of the address is in the range of 0x00 to 0x3FF.)

- To select the **Data Length** condition:
  - a. Press **Address** to set the SDA address length to 7 bit or 10 bit.
  - b. Press **Byte Length** softkey and set the byte length using the Universal Knob. The range of the Byte Length is 1 to 12.

---

## I2C Serial Decode

After completing the setup of I2C signal and trigger, we will decode I2C signals.

Steps are as follows.

1. Press **Decode** → **Decode**. Select one of the options from the **Decode1** and **Decode2**.



Figure 41 I2C Decode Menu

2. Press **Display** and select **On** to display the result of decoding.
3. Press **List** to enter the **LIST** function menu.
4. Press **Display** and choose the same options as the first step.
5. Press **Lines** and set the number of lines using the Universal Knob. The range of the lines is 1 to 7.
6. Press **Format** to change the character encoding format of the decoding's result.
7. Press **Scroll** and turn the Universal Knob to view all frames.

---

## Interpreting I2C Decode

### The frames of decoding result:

- The address of write frame is a dark-green string that contains “W”.
- The address of read frame is a yellow string that contains “R”.
- The data of data frames are white strings.

### The lists of decoding results:

- NO — the number of frames in the screen.
- TIME (timestamp) — the horizontal displacement between the current frame and the trigger position.
- ADDRESS — the address of a frame.
- R/W — the type of a frame (write or read).
- DATA — the value of data.

---

# SPI Triggering and Serial Decode

Three simple steps are necessary to trigger and decode the signals: “**Setup for SPI Signals**”, “**SPI Triggering**” and “**SPI Decode**” to trigger and decode the signals.

## Setup for SPI Signals

Setting the SPI (Serial Peripheral Interface) signal includes two steps: connecting the CLK, MISO, MOSI and CS signals to oscilloscope; specifying the parameters of each input signal.

1. Press the **Decode** key to enter the **DECODE** function menu.
2. Press the **Decode** softkey and select the desired decoder (Decode1 or Decode2).
3. Press **Protocol** softkey and then select **SPI** by turning the Universal Knob.
4. Press **Signal** softkey to enter the **SIGNAL** menu as Figure 45 shows.



Figure 42 SIGNAL Menu

5. Set CLK (clock signal):
  - a. Press the **CLK** softkey to enter **CLK** menu.
  - b. Press the **CLK** softkey to select the channel that is connected to the SPI clock signal.
  - c. Press the **Threshold** softkey to set the SPI clock signal's threshold voltage level using the Universal Knob. The threshold voltage level is for decoding, and it will be used as the trigger voltage level when setting the trigger type to serial.
  - d. Press the **Edge Select** softkey to set the oscilloscope to sample at the clock signal's rising edge or falling edge.
  - e. Press  softkey to return to the previous menu.

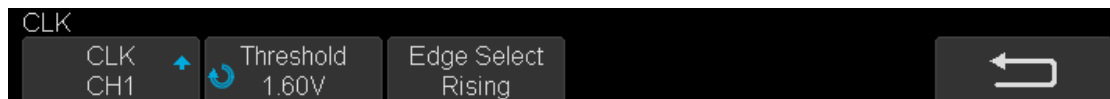

Figure 43 CLK Menu

6. Set MISO:
  - a. Press the **MISO** softkey to enter the MISO menu.
  - b. Press the **MISO** softkey to select the channel that is connected to the SPI MISO signal.
  - c. Press the **Threshold** softkey to set the SPI MISO signal's threshold voltage level using the Universal Knob. The threshold voltage level is for decoding, and it will be used as the trigger voltage level when setting the trigger type to serial.
  - d. Press  softkey to return previous menu.



Figure 44 MISO Menu

7. Set MOSI:
  - a. Press the **MOSI** softkey to enter the MOSI menu.
  - b. Press the **MOSI** softkey to select the channel that is connected to the SPI MOSI signal.
  - c. Press the **Threshold** softkey to set the SPI MOSI signal's threshold voltage level using the Universal Knob. The threshold voltage level is for decoding, and it will be used as the trigger voltage level when setting the trigger type to serial.
  - d. Press  softkey to return previous menu.



Figure 45 MOSI Menu

8. Set CS:
  - a. Press the **CS** softkey to enter the MOSI menu.
  - b. Press the **CS Type** softkey to select the chip select type.
  - c. Modify the CS type's value.
  - d. Press  softkey to return previous menu.

Table 1 Menu Explanations of the CS Type Parameters

Function Menu	Settings	Explanation
CS Type	~CS	low voltage level of CS signal is available
	CS	high voltage level of CS signal is available
	CLK Timeout	If the time between two edges of clock signal is less than (or equal to) the value of timeout, the signal between the two edges is treated as a frame. The range of clock timeout is 100ns-5ms.

9. Press the **Bit Order** softkey to select the bit order (**LSB** or **MSB**).

---

## SPI Triggering

This part will provide a brief introduction and description for the operation of the SPI trigger.

1. Press **Setup** key to enter the **TRIGGER** function menu.
2. Press **Type** and select **Serial**.
3. Press **Protocol** and select **SPI**.
4. Press **Trigger Setting** softkey.



Figure 46 SPI TRIG SET Menu

5. Press the **Trigger Type** softkey to select the trigger condition.

Table 2 Menu, the SPI trigger types

Function Menu	Settings	Explanation
Trigger Type	MISO	Master-In, Slave-Out
	MOSI	Master-Out, Slave-In

6. Press the **Data Length** softkey, and turn the Universal Knob to set the length of a data.  
The range of data length is 4 to 96 bits.
7. Set the value of the trigger data.
  - Set the value of a bit:
    - a. Press the **Bit Roll** softkey to select a bit in the data.
    - b. Press the **Bit Value** softkey to set the value of the selected bit.
  - Set the value of all bits:
    - a. Press the **All Same** softkey to set the value of all bits.

---

Table 3 Menu Explanation of the SPI Bit value

Function Menu	Settings	Explanation
Bit Value	0	High voltage level
	1	Low voltage level
	X	Don't care the voltage level

8. Press the **Next Page** softkey.
9. Press the **Bit Order** softkey to set the bit order (MSB or LSB).



---

## SPI Serial Decode

After completing the setup of SPI signal and trigger, we will decode SPI signals.

Operation steps as follows.

1. Press **Decode** → **Decode**. Select one of the options from the **Decode1** and **Decode2**.
2. Press **Display** and select **On** to display the result of decoding.
3. Press **List** to enter the **LIST** function menu.
4. Press **Display** and choose the same options as the first step.
5. Press **Lines** and set the number of lines using the Universal Knob. The range of the lines is 1 to 7.
6. Press **Format** to change the character encoding format of the decoder's result.
7. Press **Scroll** and turn the Universal Knob to view all frames.

---

## Interpreting SPI Decode

### The frames of decoding result:

- MISO — the decoding result of “Master-In, Slave-Out” line.
- MOSI —the decoding result of “Master-Out, Slave-In” line.

### The lists of decoding result:

- NO — the number of frames in screen.
- TIME (timestamp) — the horizontal displacement between current frame and trigger position.
- MISO — the decoding result of “Master-In, Slave-Out” line.
- MOSI —the decoding result of “Master-Out, Slave-In” line.

---

# UART/RS232 Triggering and Serial Decode

The three steps to set up the UART / RS232: “**Setup for UART/RS232 Signals**”, “**UART/RS232 Triggering**” and “**UART/RS232 Decode**” to trigger and decode the signals.

## Setup for UART/RS232 Signals

1. Press the **Decode** key to enter the **DECODE** function menu.
2. Press the **Decode** softkey and select the desired decoder (Decode1 or Decode2).
3. Press **Protocol** softkey and then select **UART** by turning the Universal Knob.
4. Press **Signal** softkey to enter the **SIGNAL** menu as in Figure 50 below.



Figure 47 UART SIGNAL Menu

5. Set RX:
  - 1) Press **RX** to select the channel that is connected to the RX signal.
  - 2) Press the **Threshold** key to set the RX signal's threshold voltage level using the Universal Knob. The threshold voltage level is for decoding, and it will be used as the trigger voltage level when setting the trigger type to serial.
6. Set TX:
  - 1) Press **TX** to select the channel that is connected to the TX signal.
  - 2) Press first **Threshold** key to set the TX signal's threshold voltage level by Universal Knob. The threshold voltage level is for decoding, and it will be regard as the trigger voltage level when set the trigger type to serial.
7. Press  softkey to return previous menu.
8. Press the **Configure** softkey to enter **BUS CONFIG** menu.



Figure 48 BUS CONFIG Menu

9. Press **Baud** softkey to set baud rate.
  - The baud rate can be set as a predefined value.
  - If the desired baud rate is not listed, press **Baud** and select **custom** option, press the **Custom** and turn the Universal Knob to set the desired baud rate.
10. Press **Data Length** softkey and set byte bits (5-8) using the Universal Knob.
11. Press **Parity Check** softkey to set the type of parity check (Even, Odd or None).
12. Press **Stop Bit** softkey to set the length of stop bit (1, 1.5 or 2 bits).
13. Press **Next Page** softkey.
14. Press the **Bit Order** softkey to select the bit order (**LSB** or **MSB**).
15. Press **Idle Level** softkey to set the idle level (LOW or HIGH).

---

## UART/RS232 Triggering

This part shows a brief introduction and description for the operation of the UART trigger.

1. Press **Setup** key to enter the **TRIGGER** function menu.
2. Press **Type** and select **Serial**.
3. Press **Protocol** and select **UART**.
4. Press **Trigger Setting** softkey to enter **UART TRIG SET** menu.



Figure 49 UART TRIG SET Menu

5. Press the **Source Type** softkey to select the source of the trigger (RX or TX).
6. Press the **Condition** softkey and set up the desired trigger condition:
  - **Start** — the oscilloscope will be triggered at the position of the start bit.
  - **Stop** —the oscilloscope will be triggered at the position of stop bits.
  - **Data** — the oscilloscope will be triggered when a byte is found which is equal to (not greater or less than) the specified data.
    - a. Press the **Compare Type** softkey and choose an equality qualifier (>, < or =).
    - b. Press the **Value** softkey to set the data value. Select a Data value is in range of 0x00 to 0xff.
  - **ERROR** — if the parity check has been set, and the checked parity bit shows an error, then the oscilloscope will be triggered.

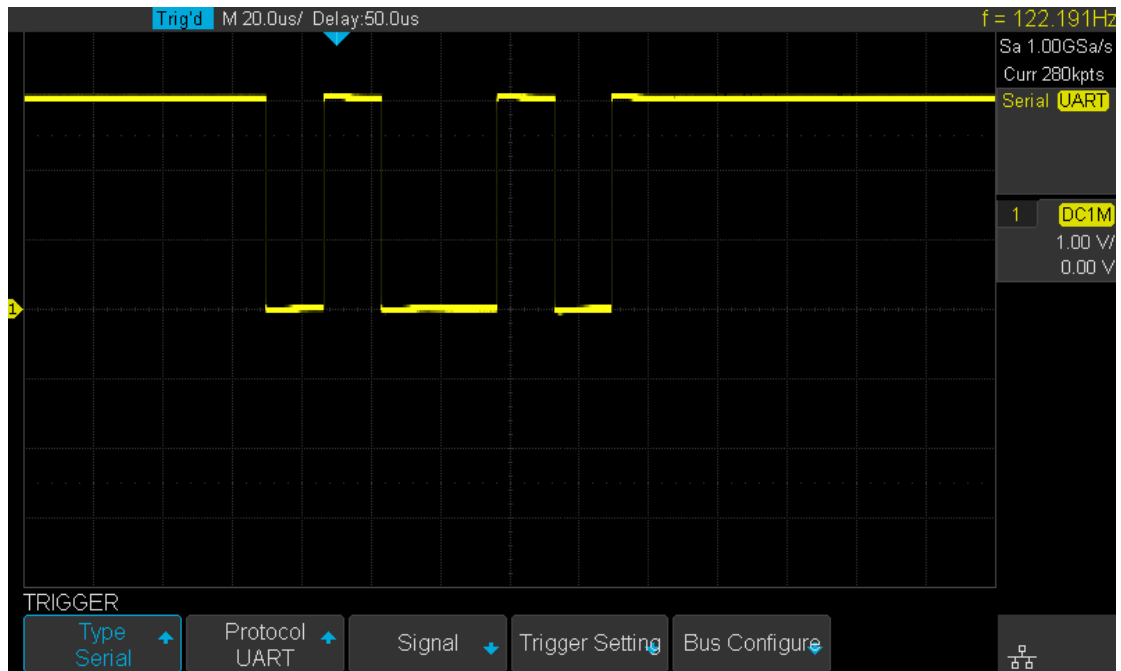

Figure 50 UART Trigger

---

## UART/RS232 Serial Decode

After completing the setup of UART signal and trigger, we will decode UART signals.

Operation steps as follows.

1. Press **Decode** → **Decode**. Select one of the options from the **Decode1** and **Decode2**.
2. Press **Display** and select **On** to display the result of decoding.
3. Press **List** to enter the **LIST** function menu.
4. Press **Display** and choose the same options as the first step.
5. Press **Lines** and set the number of lines using the Universal Knob. The range of the lines is 1 to 7.
6. Press **Format** to change the character encoding format of the decoding's result.
7. Press **Scroll** and turn the Universal Knob to view all frames.

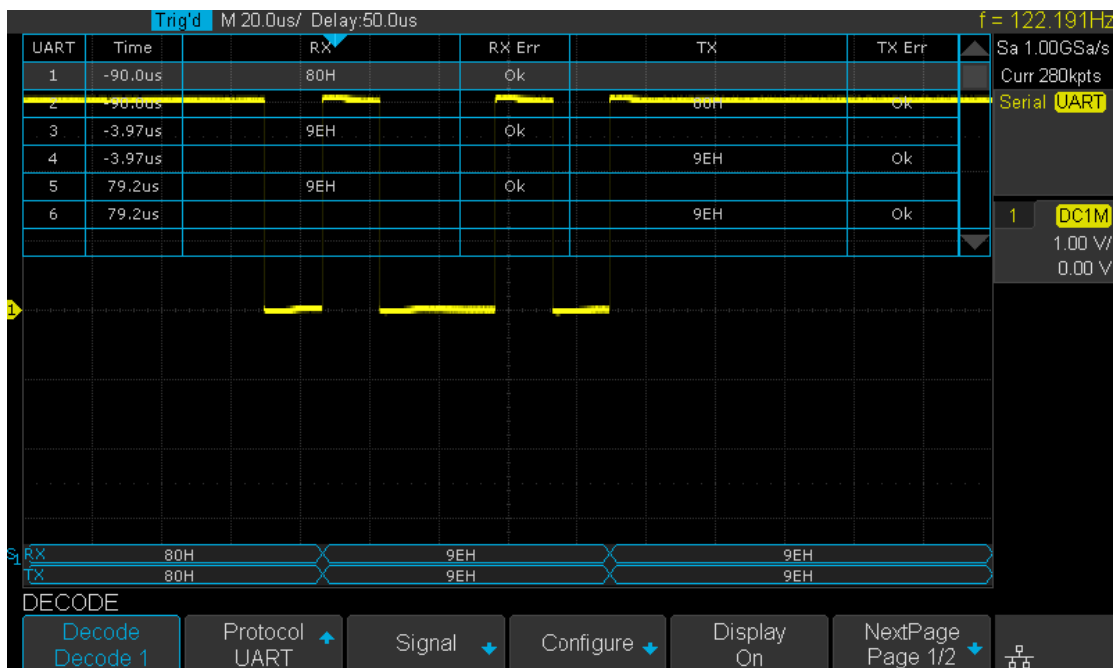

Figure 51 UART/RS232 Decode

---

## Interpreting UART/RS232 Decode

### The frames of decoding result:

- RX — the decoding result of the data received.
- TX — the decoding result of the data transmitted.

### The lists of decoding result:

- NO — the number of frames on the display.
- TIME (timestamp) — the horizontal displacement between current frame and trigger position.
- RX — the receiving channel.
- TX — the transmitting channel.
- RX ERR— Parity error or unknown error in the data received.
- TX ERR— Parity error or unknown error in the data transmitted.



---

## CAN Trigger and Serial Decode

The steps required for CAN trigger and decode “**Setup for CAN Signals**”, “**CAN Triggering**” and “**CAN Serial Decode**” to trigger and decode the signals.

### Setup for CAN Signals

1. Press the **Decode** key to enter the **DECODE** function menu.
2. Press the **Decode** softkey and select the desired decoder (Decode1 or Decode2).
3. Press **Protocol** softkey and then select **CAN** by turning Universal Knob.
4. Press **Signal** softkey to enter the **SIGNAL** menu as Figure 55 shows.



Figure 52 CAN SIGNAL Menu

5. Set CAN-H:
  - a. Press **CAN-H** softkey to select the channel that is connected to the CAN-H signal.
  - b. Press first **Threshold** key to set the CAN-H signal’s threshold voltage level using the **Universal Knob**. The threshold voltage level is for decoding, and it will be used as the trigger voltage level when setting the trigger type to serial.
6. Set CAN-L:
  - a. Press **CAN-L** to select the channel that is connected to the CAN-L signal.
  - b. Press second **Threshold** key to set the CAN-L signal’s threshold voltage level using the **Universal Knob**. The threshold voltage level is for decoding, and it will be used as the trigger voltage level when setting the trigger type to serial.
7. Press the **Configure** softkey to enter the **BUS CONFIG** menu.
8. Press **Baud** to set baud rate using the Universal Knob.
  - The baud rate can be set at predefined values (from 5kb/s to 1Mb/s) or custom values (from 5kb/s to 1Mb/s).
  - If the desired baud rate is not listed, press **Baud** and select **custom** option, press

---

the **Custom** and turn the Universal Knob to set the desired baud rate.

9. Press **Decode Source** to select the signal to be decoded.

- **CAN\_H** — CAN\_H signal will be decoded.
- **CAN\_L** — CAN\_L signal will be decoded.
- **CAN\_H-CAN\_L** — CAN\_H and CAN\_L are both used as the source of decoding.

---

## CAN Triggering

This part will provide a brief introduction and description for the operation of the LIN trigger.

### To introduce the trigger conditions

- **Start**— the oscilloscope will be triggered at the start bit of a frame.
- **Remote** — the oscilloscope will be triggered by a remote frame with specified ID.
- **ID** — the oscilloscope will be triggered by a remote or data frame that has a specified ID.
- **ID+DATA**— the oscilloscope will be triggered by a data frame that has a specified ID and data.
- **Error** — the oscilloscope will be triggered by an error frame.

### Operation steps:

1. Press **Setup** to enter the **TRIGGER** function menu.
2. Press **Type** and select **Serial**.
3. Press **Protocol** and select **CAN**.
4. Press **Trigger Setting** to enter the **CAN TRIG SET** menu.
5. Press **Condition** and select the trigger condition using the Universal Knob:
  - If you select the **REMOTE** and **ID** condition:
    - a. Press **ID Bits** to set the length of the ID (11bits or 29 bits).
    - b. Press **Curr ID Byte** and use Universal Knob to select the byte that you want to set.
    - c. Press the **ID** and set the ID's value using the Universal Knob.

(**Tips:** In order to make it convenient for the operator to set the parameters, ID length is split into several bytes. For example, if the ID's length is 11 bits, it will be split into two bytes, a byte is 8 bits. If "1st byte" is selected, only the 8 least

significant bits can be changed.)

- If you select the **ID+DATA** condition:
  - a. Press **ID bits** softkey to select the ID's length (11 or 29 bits).
  - b. Press **Curr ID Byte** softkey and use Universal Knob to select the byte that you want to modify.
  - c. Press the **ID** softkey and set the ID's value using the Universal Knob.
  - d. Press **Data1** softkey and set the value of the first byte using the Universal Knob.
  - e. Press **Data2** softkey and set the value of the second byte using the Universal Knob.

See figure 56, the trigger condition is ID, ID's value is 0x013, Baud rate is 100kb/s:

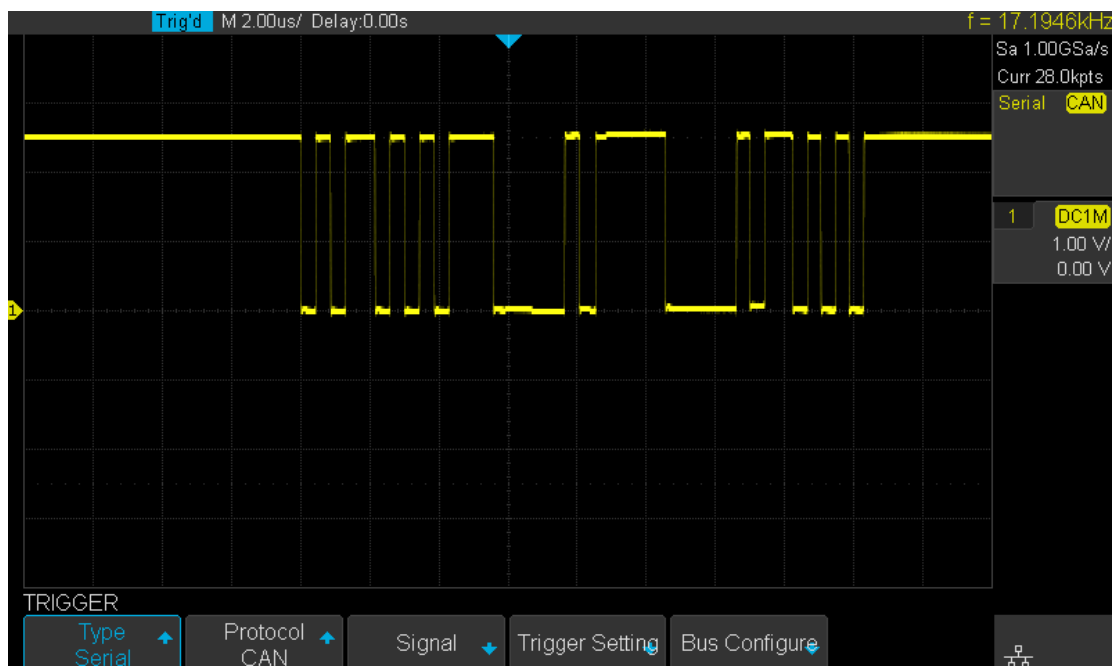

Figure 53 CAN Trigger

---

## CAN Serial Decode

We will decode CAN signals after completing the setup of the CAN signal and trigger.

Operation steps as follows.

1. Press **Decode** → **Decode**. Select one of the options from the **Decode1** and **Decode2**.
2. Press **Display** and select **On** to display the result of decoding.
3. Press **List** to enter the **LIST** function menu.
4. Press **Display** and choose the same options as the first step.
5. Press **Lines** and set the number of lines using the Universal Knob. The range of the lines is 1 to 7.
6. Press **Format** to change the character encoding format of the decoder's result.
7. Press **Scroll** and turn the Universal Knob to view all frames.

---

## Interpreting CAN Decode.

### The frame of decoding results:

- Arbitration field is displayed in the frame
- Control field is displayed in the frame
- Data field is displayed in the frame
- CRC field is displayed in the frame

### The list of decoding result:

- NO — the number of frames on the screen.
- TIME (timestamp) — the horizontal displacement between current frame and trigger position.
- TYPE — the type of frames, “D” represents data frame, “R” represents remote frame.
- ID — the id of frames, the oscilloscope can automatically detect the length of frame’s id (11 bits or 27 bits).
- LENGTH — the length of data field.
- DATA — the value of data field.
- CRC — the value of CRC (Cyclic Redundancy Check) field.
- ACK — Acknowledgment bit.

---

## LIN Triggering and Serial Decode

LIN Trigger and decode steps: “**Setup for LIN Signals**”, “**LIN Triggering**” and “**LIN Decode**” to trigger and decode the signals.

### Setup for LIN Signals

There are two steps for setting the LIN signal, connecting the signal to oscilloscope, specifying the parameters of each input signal.

1. Press the **Decode** key to enter the DECODE function menu.
2. Press the **Decode** softkey and select the desired decoder (Serial 1 or Serial 2).
3. Press **Protocol** softkey and then select **LIN** by turning Universal Knob.
4. Press **Signal** softkey to enter the **SIGNAL** menu as Figure 58 shows.



Figure 54 LIN SIGNAL Menu

5. Press **Source** softkey to select the channel that is connected to the LIN signal.
6. Press the **Threshold** softkey and set the LIN signal's threshold voltage level using the Universal Knob. The threshold voltage level is for decoding, and it will be used as the trigger voltage level when setting the trigger type to serial.
7. Press **Return** softkey to return to the previous menu.
8. Press the **Configure** softkey to enter the **BUS CONFIG** menu.
9. Press **Baud** softkey to set baud rate.
  - The baud rate can be set as a predefined value.
  - If the desired baud rate is not listed, select **custom** option, press the **Custom** and turn the Universal Knob to set the desired baud rate.

---

## LIN Triggering

This part will provide a brief introduction and description for the operation of the LIN trigger.

### The possible trigger conditions

- **Break** — The oscilloscope will be triggered at the position of break field's break delimiter.
- **ID (Frame ID)** — the oscilloscope will be triggered at the position of the identifier field's stop bit, if the value of a frame's ID is equal to specified value.  
(Note: If the data's value is 0xXX, any data value will be matched)
- **ID + Data (Frame ID and Data)** — the oscilloscope triggers when a frame with an ID and data equal to the selected values is detected. Use the Universal Knob to select the value for the ID, Data1 and Data2.
  - 1) The ID's value is the same as the value currently set.
  - 2) If you have set either Data1's or Data2's value, and the signal has data that matches that value. If you have set both Data1's and Data2's value, the signal should have two consecutive data, the first data's value is Data1, the second data value is Data2.  
(**Note:** If the data's value is 0xXX, any data value will be matched)
- **Data Error** —the oscilloscope will be triggered when errors (such as ID check error, checksum error, sync byte field error) are detected.

### Operation steps:

1. Press **Setup** to enter the **TRIGGER** function menu.
2. Press **Type** and select **Serial**.
3. Press **Protocol** and select **LIN**.
4. Press **Trigger Setting** softkey to enter **LIN TRIG SET** menu.



5. Press **Condition** and select the trigger condition using the Universal Knob:

- If you **select ID** condition:
  - a. Press **ID** softkey and set its value by turning the Universal Knob.
- If you **select ID+DATA** condition:
  - a. Press **ID** softkey and set its value by turning the Universal Knob.
  - b. Press **DATA1** softkey and set its value by turning the Universal Knob.
  - c. Press **DATA2** softkey and set its value by turning the Universal Knob.

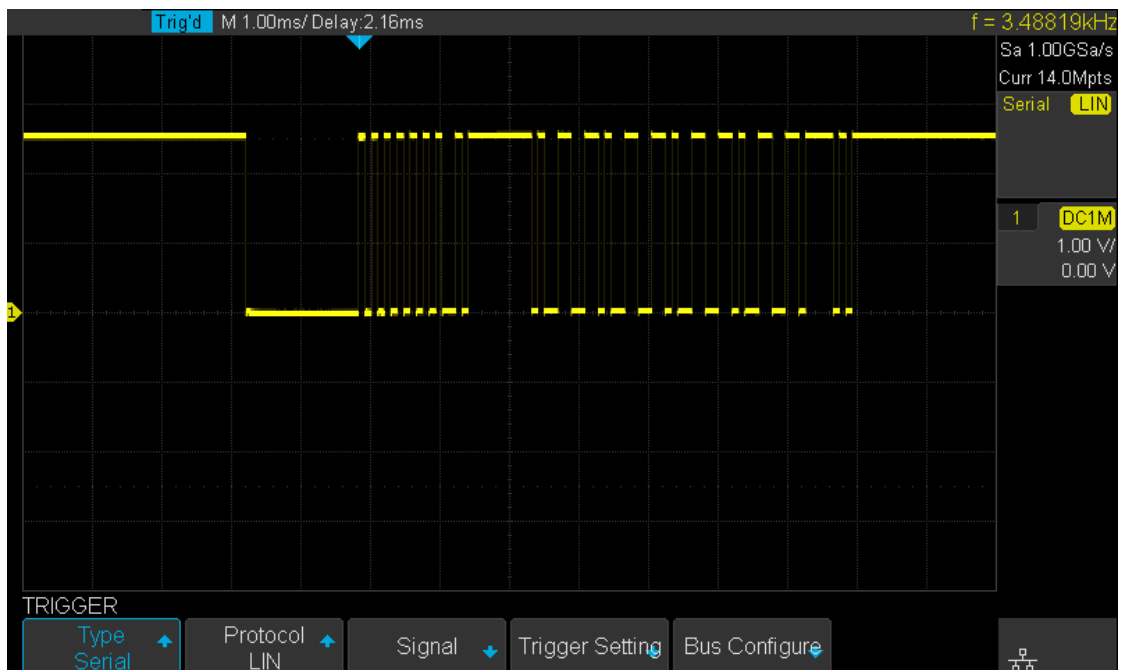

Figure 55 LIN Trigger

---

## LIN Serial Decode

After completing the setup of LIN signal and trigger, we will decode LIN signals.

Operation steps as follows.

1. Press **Decode** → **Decode**. Select one of the options from the **Decode1** and **Decode2**.
2. Press **Display** and select **On** to display the result of decoding.
3. Press **List** to enter the **LIST** function menu.
4. Press **Display** and choose the same options as the first step.
5. Press **Lines** and set the number of lines using the Universal Knob. The range of the lines is 1 to 7.
6. Press **Format** to change the character encoding format of the decoder's result.
7. Press **Scroll** and turn the Universal Knob to view all frames.

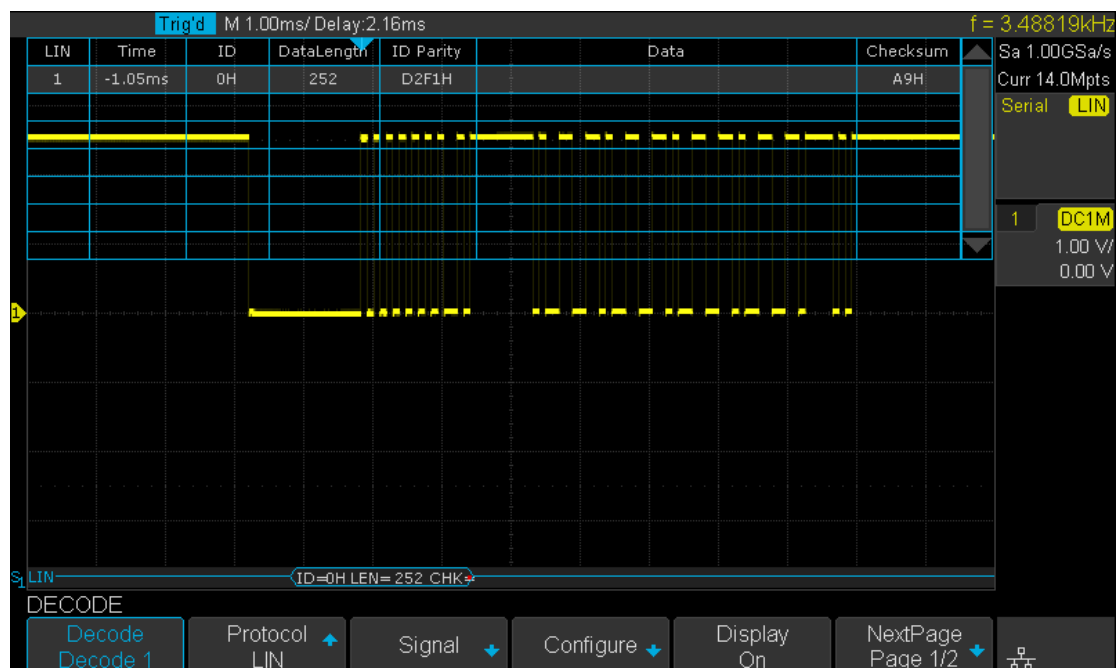

Figure 56 LIN Decode

## Interpreting LIN Decode

The frame of decoding result:

- Protected Identifier Field is displayed in frame

---

## Interpreting LIN Decode

### The frame of decoded results:

- Protected Identifier Field is displayed in frame
- Data Length is displayed in frame
- Data Field is displayed in frame.
- Checksum Field is displayed in frame.

### The list of decoding result:

- NO — the number of frames in screen.
- TIME (timestamp) — the horizontal displacement between current frame and trigger position.
- ID — the value of frame's Protected Identifier Field.
- DATA LENGTH — the length of Data Field.
- ID CHECK — the two check bits of Protected Identifier Field.
- DATA — the value of Data Field.
- DATA CHECKSUM — the value of Checksum Field.

---

## To Save A Reference Waveform

The oscilloscope can save analog channels or math waveforms to the reference waveform locations in the oscilloscope. Then, a reference waveform can be displayed and compared against other waveforms. All reference waveforms can be displayed at the same time.

The contents of this chapter:

- How to Save a REF Waveform to Internal Memory
- How to Display a REF Waveform
- How to Adjust a REF Waveform Display
- How to Clear a REF Waveform Display

---

## To Save a REF Waveform to Internal Memory

Do the following steps to save the REF waveform to internal memory:

1. Press the **REF** button on the front to enter the REF WAVE function menu. Note that when the time horizontal format is in X-Y mode, REF function cannot be enabled.
2. Press the **Source** softkey; then, turn the **Universal Knob** to select the source of the reference channel. The source includes analog channels and math waveforms.
3. Press the **Location** softkey; then, turn the **Universal Knob** to select the position to save the REF waveform. The source includes analog channels and math waveforms.
4. Press the **Save** softkey to save the channel or math waveform to the appointed location. The vertical scale information and the vertical offset of the waveform will be saved at the same time. A pop up the message “**Store Data Success**” will appear when the waveform has been saved successfully.

Note: The REF waveforms are non-volatile. The REF waveform can still be viewed after a restart or default operation.

## To Display a REF Waveform

Do the following steps to display a REF waveform:

1. Press the **REF** button on the front to enter the REF WAVE function menu.
2. Press the **Location** softkey; then, turn the **Universal Knob** to select the REF waveform that you want to display.
3. Press the **Display** softkey to select **On** to display the REF waveform on the screen.  
Only saved locations can be displayed. The oscilloscope can display all four reference waveforms at the same time.

---

## To Adjust the REF Waveform Display

1. Please refer to the “**To Display a REF Waveform**” above to display the desired reference waveform.
2. Press the **Scale** and **Position** softkey and turn the universal knob to adjust the vertical scale and position of the reference waveform. The vertical scale and position information displays in the middle of the screen.

The initial values displayed in the middle of the screen is the setup that was saved with the reference waveform.

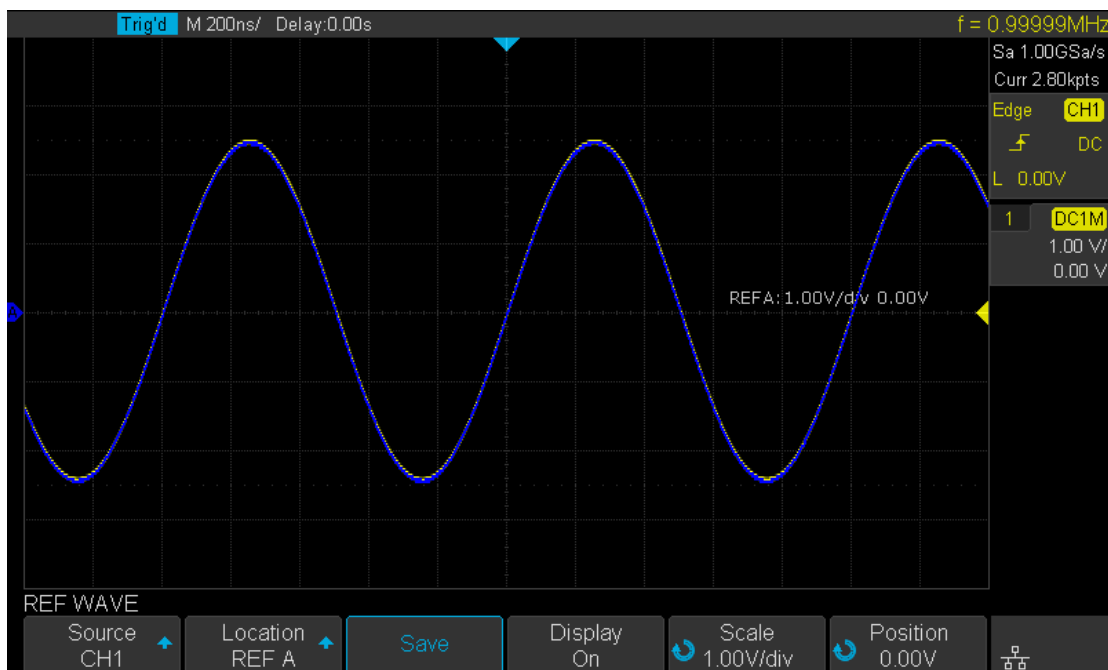

Figure 57 Reference Waveform

Note: Only the vertical Variable knob and the vertical Position knob work for the reference waveform and the math waveform.

---

## To Clear the REF Waveform Display

The oscilloscope does not have the “Clear” option under the REF WAVE function menu. To clear the appointed reference waveform, you can save a new reference waveform to the same location to replace it.

---

# To Make a Math Operation

The oscilloscope supports many math operations between analog channels including addition (+), subtraction (-), multiplication (\*), division (/), FFT, differential (d/dt), integral ( $\int dt$ ), square root ( $\sqrt{\quad}$ ). The resulting math waveform is displayed in white and labelled with "M". You can use cursors to measure it.

The contents of this chapter:

- ◆ Units for Math Waveforms
- ◆ Math Operators
- ◆ To Adjust the Math Waveform Scale and Offset

Note: if the analog channel or the math function is clipped (waveforms are not completely displayed on the screen), then the resulting math will also be clipped.

## Units for Math Waveforms

Use the channel function menu to set the unit of each channel to "V" or "A". The oscilloscope math operation includes units as below:

Math Operation	Unit
Addition (+)or subtraction (-)	V, A
multiplication (*)	V <sup>2</sup> , A <sup>2</sup> or W (Volt-Amp)
division (/)	None or S
FFT	dBVrms, Vrms, dBm, dBArms, Arms
differential (d/dt)	V/S or A/S (V/second or A/second)
integral ( $\int dt$ )	V/S or A/S (V/second or A/second)
square root ( $\sqrt{\quad}$ )	V <sup>1/2</sup> or A <sup>1/2</sup>



---

## Math Operators

The oscilloscope supports math count operation (Addition, subtraction, multiplication, division), FFT (Fourier transform) operation and math function operation (differential, integral, square root).

### Addition or Subtraction

Math operators perform arithmetic operations add or subtract operation on any two analog input channels. When you select addition or subtraction, the **Source A** and **Source B** values are added or subtracted point by point, and the result is displayed.

1. Press the **Math** button on the front panel to enter the MATH function menu.
2. Press the **Source A** and **Source B** softkey respectively, and then turn the **Universal Knob** to select the source to do math operation. Addition or Subtraction can be applied between Analog channels or between reference waveforms.
3. Press the **Operation** softkey and then turn the universal knob to select + or - to make an addition or subtraction operation. The resulting math waveform is displayed in white and labelled with "M".



Fig 58 Addition

4. If you want to invert the math waveform, press the **Invert** button and set the option to **On** to invert the display of the math waveform.

---

## Multiplication and Division

There are Math operators to perform multiplication or division arithmetic operations on anytwo analog input channels. When you select multiplication or division, the **Source A** and **Source B** values are multiplied or divided point by point and the result is displayed.

1. Press the **Math** button on the front panel to enter the MATH function menu.
2. Press the **Source A** and **Source B** softkey respectively, and then turn the **Universal Knob** to select the source to do math operation. Multiplication or Division can be applied between Analog channels or between reference waveforms.
3. Press the **Operation** softkey and then turn the universal to select \* or / to make multiplication or division operation. The resulting math waveform is displayed in white and labelled with "M".

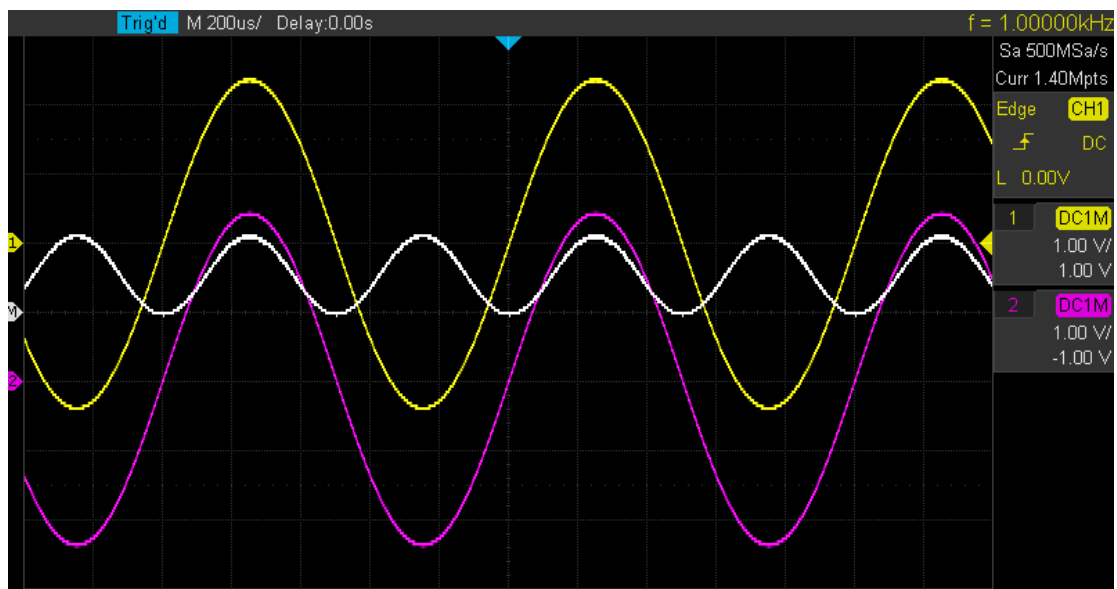

4. If you want to invert the math waveform, press the **Invert** button and set the option to **On** to invert the display of the math waveform.

---

## FFT Operation

FFT is used to compute the fast Fourier transform using analog input channels. FFT takes the digitized time record of the specified source and transforms it to the frequency domain. When the FFT function is selected, the FFT spectrum is plotted on the oscilloscope display as magnitude in dBV versus frequency. The readout for the horizontal axis changes from time to frequency (Hertz) and the vertical readout changes from volts to dB.

Typically FFT operation can be used for the following:

- ◆ Measure harmonic components and distortion in the device under test
- ◆ Measure the characteristics of the noise in DC power
- ◆ Analyze vibration

---

**To display an FFT waveform:**

1. Press the **Math** button on the front panel to open the MATH function menu.
2. Press the **Operation** softkey and then turn the **Universal Knob** to select **FFT**. The resulting math waveform is displayed in white and labeled with "M".
3. Press the **Source** softkey, and then turn the **Universal Knob** to select the source to do an FFT operation. Analog channels can be used as the source.
4. Press the **Window** softkey, and then turn the **Universal Knob** to select an appropriate window.

Spectral leakage can be considerably decreased when a window function is used. The oscilloscope provides five windows (Rectangle, Blackman, Hanning, Hamming and Flattop) which have different characteristics and are applicable to measure different waveforms. You need to select the window function according to different waveforms and their characteristics. Please read the table below carefully to make an appropriate option choice according to the input signal.

Window	Applications and Characteristics
<b>Rectangle</b>	This is normally used when the signal is transient (completely contained in the time-domain window) or known to have a fundamental frequency component that is an integer multiple of the fundamental frequency of the window. Signals other than these types will show varying amounts of spectral leakage and scallop loss, which can be corrected by selecting another type of window
<b>Hanning</b>	Reduced leakage and improve amplitude accuracy. Frequency resolution is also reduced.
<b>Hamming</b>	Reduce leakage and improve amplitude accuracy. Frequency resolution is also reduced.
<b>Flat Top</b>	This window provides excellent amplitude accuracy with moderate reduction of leakage, but with reduced frequency resolution.
<b>Blackman</b>	Leakage is reduced to a minimum, but with reduced frequency resolution.

5. Press the **Center** softkey, and then turn the **Universal Knob** to select the desired center frequency.
6. Press the **Hz/div** softkey, and then turn the **Universal Knob** to select the desired resolution frequency.
7. Press the **Scale** softkey, and then turn the **Universal Knob** to select the desired vertical FFT scale
8. Press the **Ref Level** softkey, and then turn the **Universal Knob** to select the desired vertical FFT offset.
9. Press the **Unit/Load** softkey to enter Unit/Load menu. Press **Unit** softkey to select the unit of vertical axis. The units of the vertical axis can be dBVrms, dBm or Vrms which use a logarithmic scale or a linear scale to display vertical amplitude respectively. If you need to display the FFT frequency spectrum in a relatively larger dynamic range, dBVrms is recommended. Press **Ext Load** softkey, and then turn the **Universal Knob** to select the external load value.

10. Press the **Display** softkey to select **Split, Full Screen or Exclusive** display mode.
  - **Split:** the source channel and the FFT operation results are displayed separately. The time domain and frequency domain signals are displayed clearly.
  - **Full Screen:** the source channel and the FFT operation results are displayed in the same window to view the frequency spectrum more clearly and to perform more precise measurements.
  - **Exclusive:** the waveforms of channels are disabled, only the FFT operation results are displayed in the window to view the frequency spectrum more clearly and to perform more precise measurements.

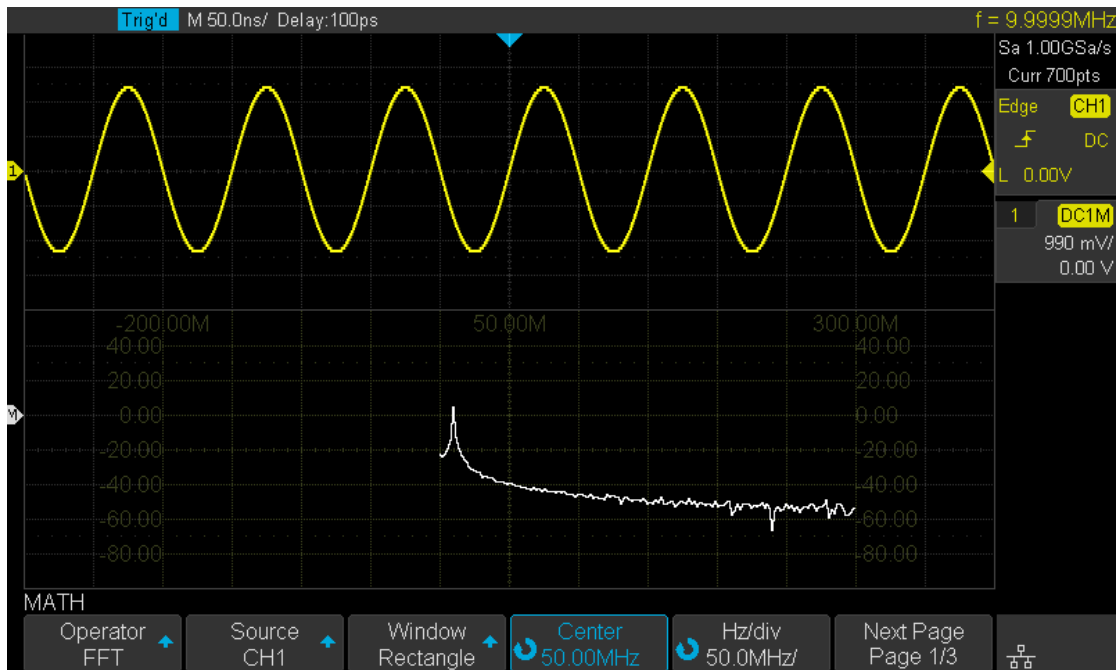

Figure 59 FFT Waveform in Split Mode

11. Press the **Max Points** softkey to select the maximum number of points which are used to compute the FFT waveform.
12. Press the **Autoset** softkey to automatically set the appropriate parameters for the FFT measurement.
13. Press the **Max-Hold** softkey to turn on or turn off the Max Hold function.

**Note:**

- Signals with DC components or deviation would cause error or deviation of the FFT waveform components. To reduce the DC components, set the Channel **Coupling** to **AC**.
- To reduce the random noise and aliasing frequency components of repetitive or single pulse, set the **Acquisition** of the oscilloscope to **Average**.

---

### To measure FFT waveform:

To make cursor measurements, press the **Cursors** button, and then press the **Mode** softkey to select **On** to turn the cursors on, Use the X1 and X2 cursors to measure frequency values and the difference between two frequency values ( $\Delta X$ ). Use the Y1 and Y2 cursors to measure amplitude in dB and difference in amplitude ( $\Delta Y$ ). You can find the frequency value at the first occurrence of the waveform maximum by using the X at Max Y measurement.

Note: please refer to the cursors chapter to understand how to use the cursors.

## Math Function Operation

The oscilloscope supports math function operation including differential ( $d/dt$ ), integral ( $\int dt$ ) and square root ( $\sqrt{\quad}$ ).

### Differentiate

**d/dt** (differentiate) calculates the discrete time derivative of the selected source.

$$d_i = \frac{y(i + \Delta t) - y(i - \Delta t)}{2 \Delta t}$$

Where:

- $d$  = differential waveform.
- $y$  = channel 1, 2, 3, or 4 data points.
- $i$  = data point index
- $\Delta t$  = point- to- point time difference.

The **dx** option under  $d/dt$  math function operation menu shows the point- to- point time difference, and it ranges from 0.02div to 0.40div. "div" indicates the number of the pixel points that each division has. The oscilloscope has 50 pixel points per division. Take 0.2div as an example:  $0.2 * 50 = 10$ . It means to calculate the ten point's discrete time derivative of the selected source, and the  $\Delta t$  is the ten point's point- to- point time difference.

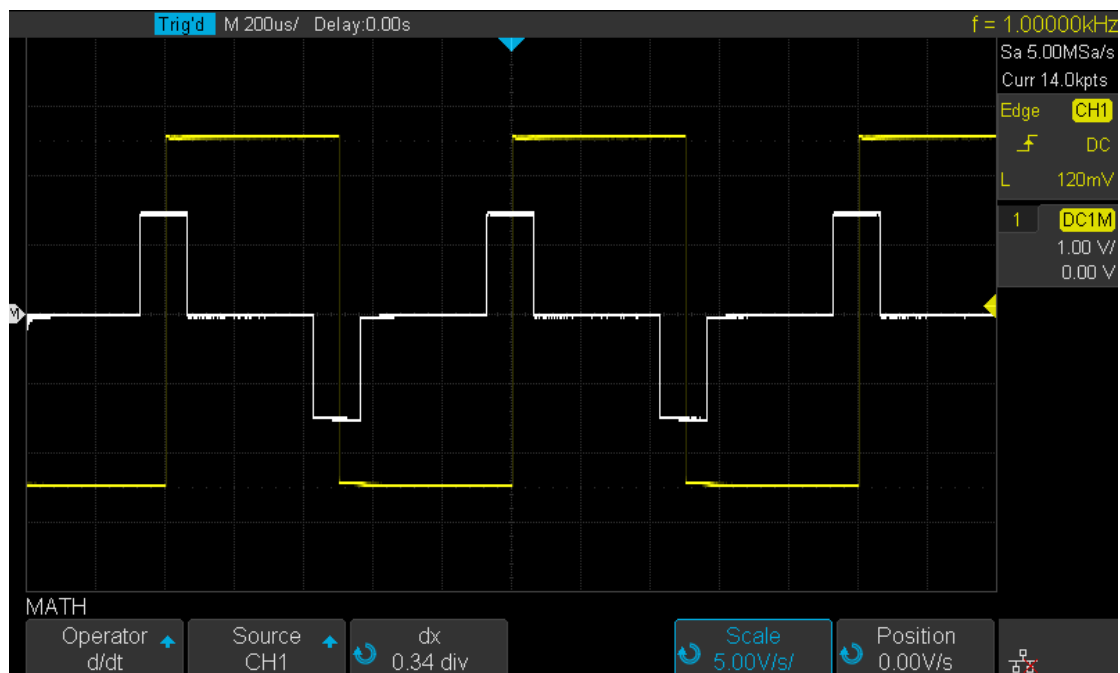

Figure 60 Differential Function Operation

You can use differentiate to measure the instantaneous slope of a waveform. For example, the slew rate of an operational amplifier may be measured using the differentiate function.

Note: Because differentiation is very sensitive to noise, it is helpful to set acquisition mode to **Average**.

## Integrate

dt (integrate) calculates the integral of the selected source. You can use integrate to calculate the energy of a pulse in volt- seconds or measure the area under a waveform. dt plots the integral of the source using the "Trapezoidal Rule". The equation is:

$$I_n = c_0 + \Delta t \sum_{i=0}^n y_i$$

Where:

- I = integrated waveform;
- $\Delta t$  = point- to- point time difference;
- y = channel 1, 2, or REFA,REFB
- $c_0$  = arbitrary constant;
- i = data point index;

The integrate operator provides an **Offset** softkey that lets you enter a DC offset correction factor for the input signal. Small DC offset in the integrate function input (or even small oscilloscope calibration errors) can cause the integrate function output to "ramp" up or down. This DC offset correction lets you level the integrate waveform.

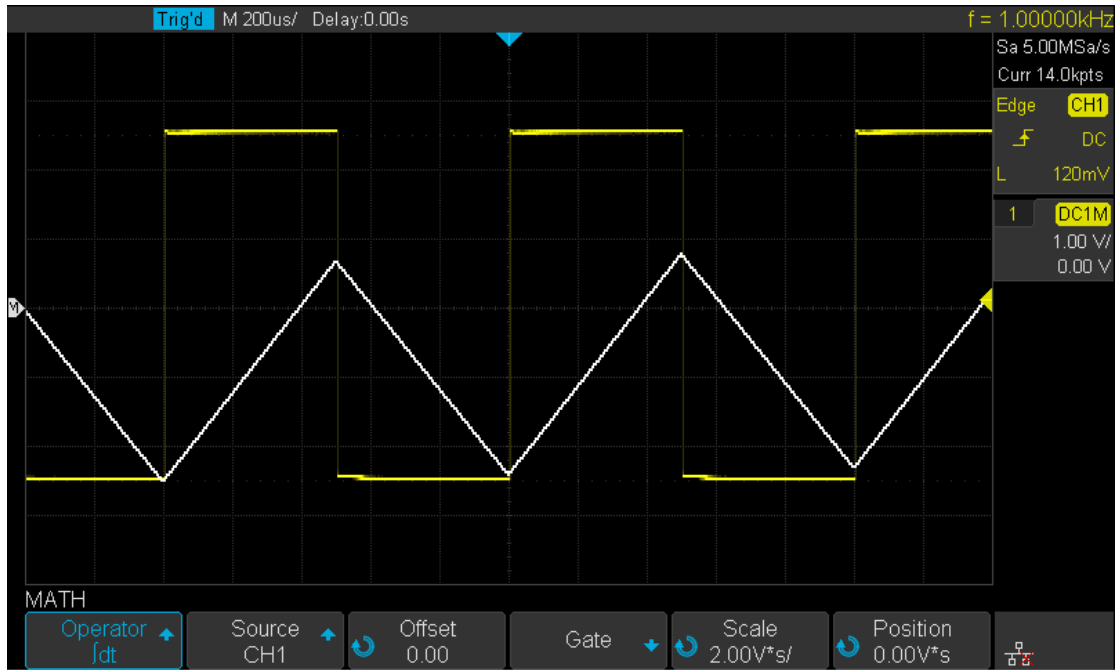

Figure 61 Integral without Offset

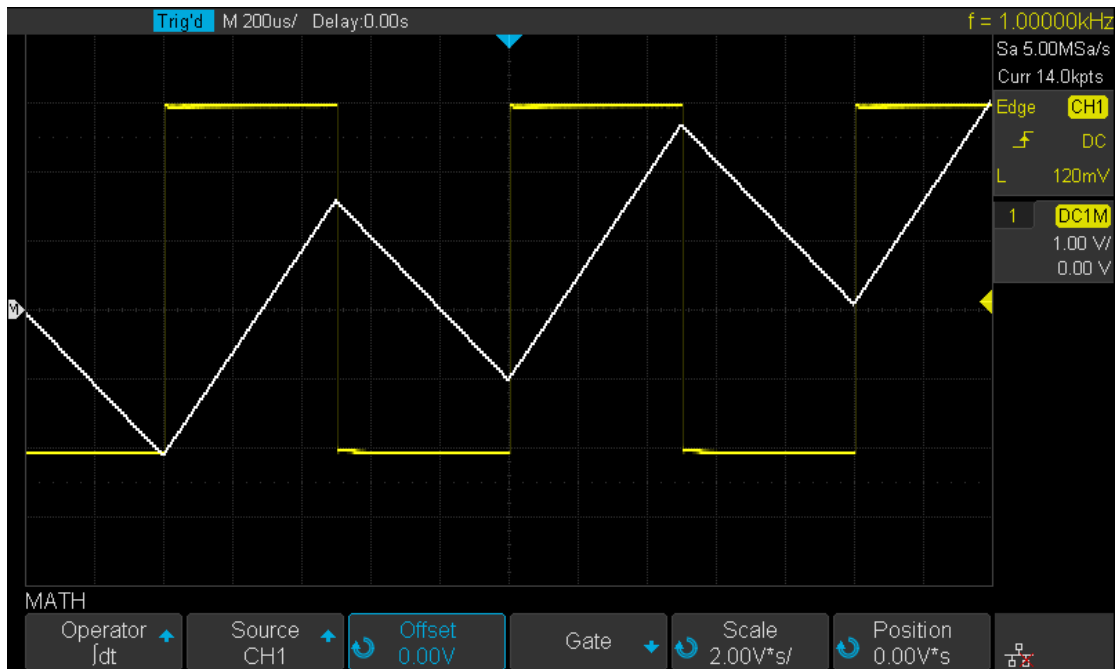

Figure 62 Integral with Offset

## Square Root

Square root ( $\sqrt{\quad}$ ) calculates the square root of the selected source.

Where the transform is undefined for a particular input, holes (zero values) appear in the



function output.

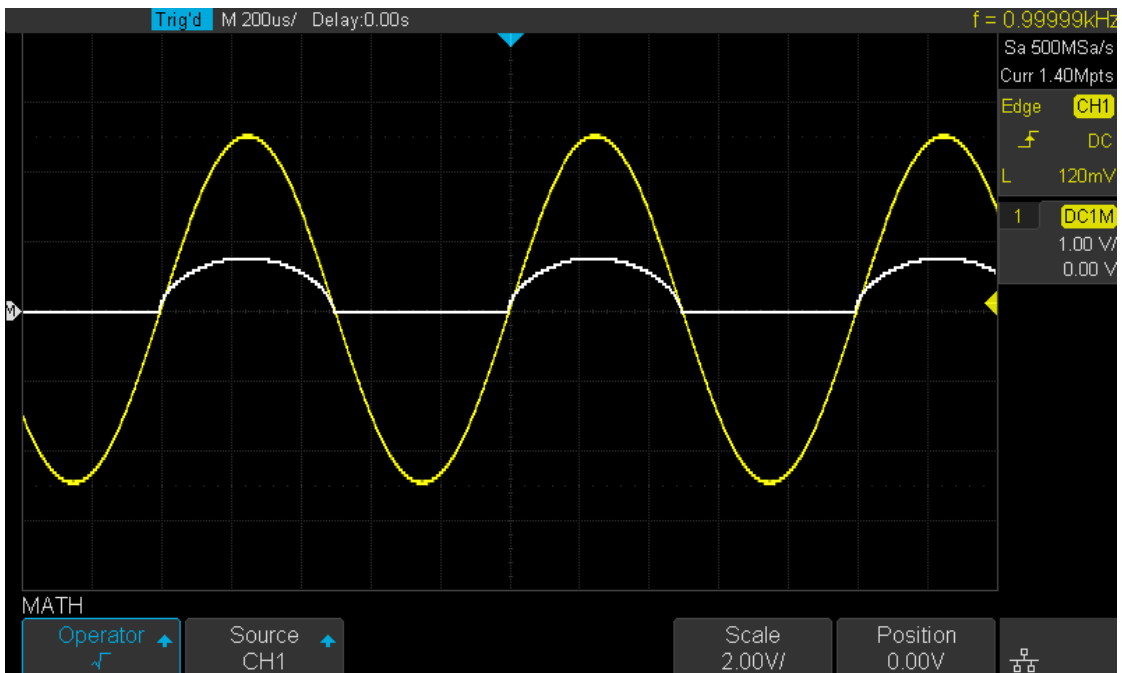

Figure 63 Square Root

---

# To Make Cursors Measurements

Cursors are horizontal and vertical markers that indicate X- axis values and Y- axis values on a selected waveform source. You can use cursors to make custom voltage or time measurements on oscilloscope signals.

## X Cursors

X cursors are vertical dashed lines that adjust horizontally and can be used to measure time (when the source is FFT waveform, X cursors measure frequency)

**X1** cursor is the left (default position) vertical dotted line; it can be moved to any place of the screen.

**X2** cursor is the right (default position) vertical dotted line; it can be moved to any place of the screen.

Use the **Universal Knob** to set the **X1** and **X2** cursor values. The values are displayed in the cursors box in the upper-left corner of the screen along with the difference between X1 and X2 ( $\Delta T$ ) and  $1/\Delta T$ .

When cursor type is set to **X2-X1**, use the **Universal Knob** will move the X1 and X2 cursors together. The value under the menu option is the difference between the X1 and X2 cursors.

## Y Cursors

Y cursors are horizontal dotted lines that adjust vertically and can be used to measure voltage (V) or current (A). When the cursors source is the math function, the unit will match the math function.

**Y1** cursor is the top (default position) horizontal dotted line; it can be moved to any vertical place of the screen.

**Y2** cursor is the bottom (default position) horizontal dotted line; it can be moved to any vertical place of the screen.

Use the **Universal Knob** to set the Y1 and Y2 cursor values and the values are displayed in the cursors box in the top left corner of the screen along with the difference between Y1 and Y2 ( $\Delta Y$ ).

When cursor type is set to **Y2-Y1**, use the **Universal Knob** will move the Y1 and Y2 cursors together. The value under the menu option is the difference between the Y1 and Y2 cursors.

---

## To Make Cursor Measurements

1. Press the **Cursors** button on the front panel to enter the CURSOR function menu.
2. Press the **Mode** softkey and set the option to **On**.
3. Press the **Source** softkey, and then use the **Universal Knob** to select the desired source. Only analog channels, math waveforms and reference waveforms that are displayed are available for cursors.
4. To make cursor measurements:
  - To measure the horizontal time, use the **Universal Knob** to move the X1 and X2 cursors to desired place. If necessary, set the cursor type to **X2-X1**, move X1 and X2 cursors together.
  - To measure vertical voltage or current, use the **Universal Knob** to move the Y1 and Y2 cursors to desired place. If necessary, set the cursor type to "Y2-Y1", move Y1 and Y2 cursors together.
  - To adjust the transparency of the cursors message box, press the **Display/Persist** softkey and go to the second page, press the **Transparence** (20% to 80%) softkey and then turn the **Universal Knob** to adjust the transparence to the desired value.

### Cursor examples:

1. Use cursors to measure a pulse width:

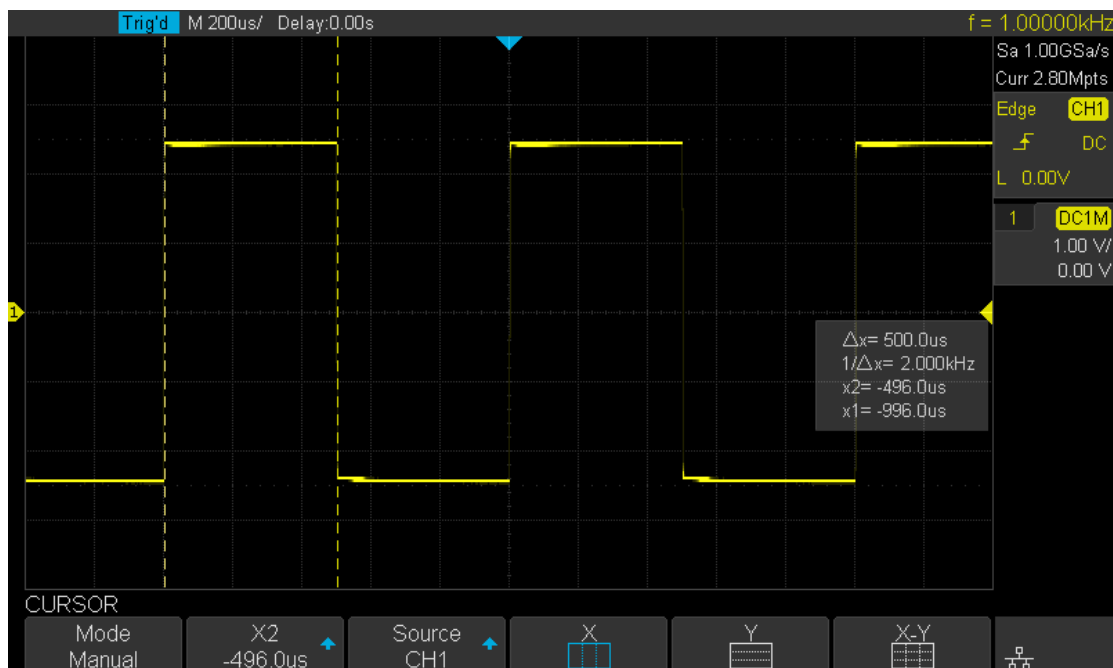

Figure 64 Measure Pulse Width

---

# How To Make Automatic Measurements

The oscilloscope provides measurements of 36 waveform parameters and the statistics. It contains voltage, time and delay parameters.

Voltage and time parameters are under the Type option. The results of the last five selected measurements are displayed at the bottom of screen, above the menu. Delay parameters are under the **All Measure** submenu. Set the Delay option to On to display all the delay parameters.

The contents of this chapter:

- ◆ Type of measurements
  - Voltage Measurements
  - Time Measurements
  - Delay Measurements
- ◆ To make automatic measurement
- ◆ To clear measurements
- ◆ To make all parameters measurement

---

## Type of Measurements

### Voltage Measurements

Voltage measurements include 15 kinds of voltage parameter measurements.

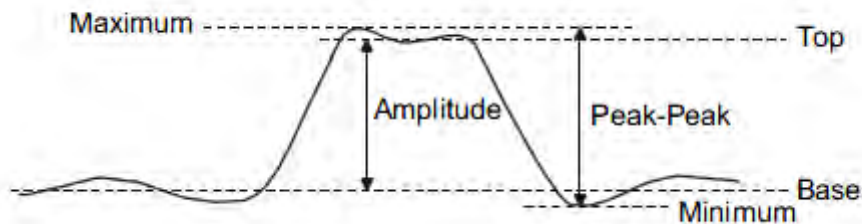

Figure 65 Voltage Measurements

1. **Pk-Pk:** Difference between maximum and minimum data values.
2. **Max:** Highest value in input waveform.
3. **Min:** Lowest value in input waveform.
4. **Ampl:** Difference between top and base in a bimodal signal, or between max and min in an unimodal signal.
5. **Top:** Value of most probable higher state in a bimodal waveform.
6. **Base:** Value of most probable lower state in a bimodal waveform.
7. **Cmean:** Average of data values in the first cycle.
8. **Mean:** Average of all data values
9. **Stdev:** Standard deviation of all data values
10. **Cstd:** Standard deviation of all data values in the first cycle
11. **Rms:** Root mean square of all data values.
12. **Crms:** Root mean square of all data values in the first cycle.
13. **Overshoot:** Overshoot is distortion that follows a major edge transition expressed as a percentage of Amplitude. ROV means rising edge overshoot and FOV means falling edge overshoot.

$$\text{Rising edge overshoot} = \frac{\text{local Maximum} - \text{D Top}}{\text{Amplitude}} \times 100$$

$$\text{Falling edge overshoot} = \frac{\text{Base} - \text{D local Minimum}}{\text{Amplitude}} \times 100$$

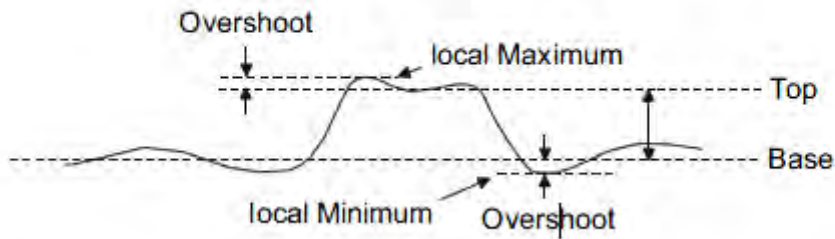

Figure 66 Overshoot

- 14. Preshoot:** Preshoot is distortion that precedes a major edge transition expressed as a percentage of Amplitude. The X cursors show which edge is being measured (edge closest to the trigger reference point).

$$\text{Rising edge preshoot} = \frac{\text{local Minimum} - \text{D Top}}{\text{Amplitude}} \times 100$$

$$\text{Falling edge preshoot} = \frac{\text{Base} - \text{D local Minimum}}{\text{Amplitude}} \times 100$$

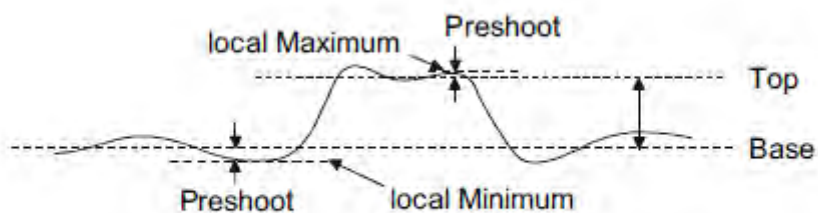

Figure 67 Preshoot

- 15. L@X:** the voltage value between the trigger point and the vertical position of the channel

---

## Time Measurements

Time measurements include 9 kinds of time parameter measurements.

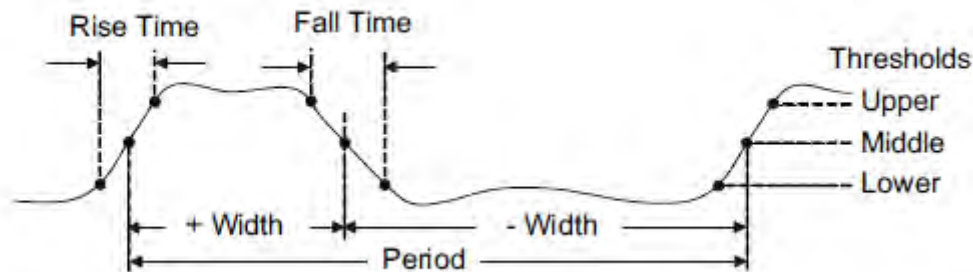

Figure 68 Time Measurements

1. **Period:** Period for every cycle in a waveform at the 50% level, using positive slope.
2. **Frequency:** Frequency for every cycle in a waveform at the 50% level, using positive Slope.
3. **+ Width:** Width measured at 50% level and positive slope.
4. **- Width:** Width measured at 50% level and negative slope.
16. **Rise Time:** Duration of rising edge from 10-90%.
5. **Fall Time:** Duration of falling edge from 90-10%.
6. **BWid:** Time from the first rising edge to the last falling edge ,or the first falling edge to the last rising edge at the 50% crossing.
7. **+ Duty:** Ratio of positive width to period.
8. **- Duty:** Ratio of negative width to period.
9. **Delay:** Time from the trigger to the first transition at the 50% crossing.
10. **T@L:** Time from trigger of each transition at a specific level and slope, include:  
Current, Max, Min, Mean, Std-dev.

---

## Delay Measurements

Delay measurements measure the time different between arbitrary two channels, including 9 kinds of delay measurements.

1. **Phase:** Calculate the phase difference between two edges.
2. **FRR:** Time between the first rising edges of the two channels.
3. **FRF:** Time from the first rising edge of channel A ,to the first falling edge of channel B.
4. **FFR:** Time from the first falling edge of channel A ,to the first rising edge of channel B.
5. **FFF:** Time from the first falling edge of channel A ,to the first falling edge of channel B.
6. **LRR:** Time from the first rising edge of channel A ,to the last rising edge of channel B.
7. **LRF:** Time from the first rising edge of channel A ,to the last falling edge of channel B.
8. **LFR:** Time from the first falling edge of channel A ,to the last rising edge of channel B.
9. **LFF:** Time from the first falling edge of channel A ,to the last falling edge of channel B.



## Automatic Measurements

Perform the steps below and select voltage or time parameters to make automatic measurements.

1. Press the **Measure** button on the front panel to enter the MEASURE function menu. The frequency and period will be enabled on the current trigger channel along with the statistics.
2. Press the **Source** softkey, and then use the **Universal Knob** to select the desired channel. Only analog channels that are displayed are available for measurements.
3. To select and display measurement parameters. Press the **Type** softkey, and then turn the **Universal Knob** to select the desired measurement parameter.
4. Press the **Universal Knob** to add the measurement parameter, the parameters and value will be shown above the menu, and the statistics status will update.
5. To turn off the statistic function, press the **Statistics** softkey to select **Off**.

The measurement display area can display 4 measurement parameters at most, and the measurements will display according to the selecting order. If a fifth measurement Parameter is added, the first measurement parameter will be deleted (FIFO).



Figure 69 Select the Measurement Parameter

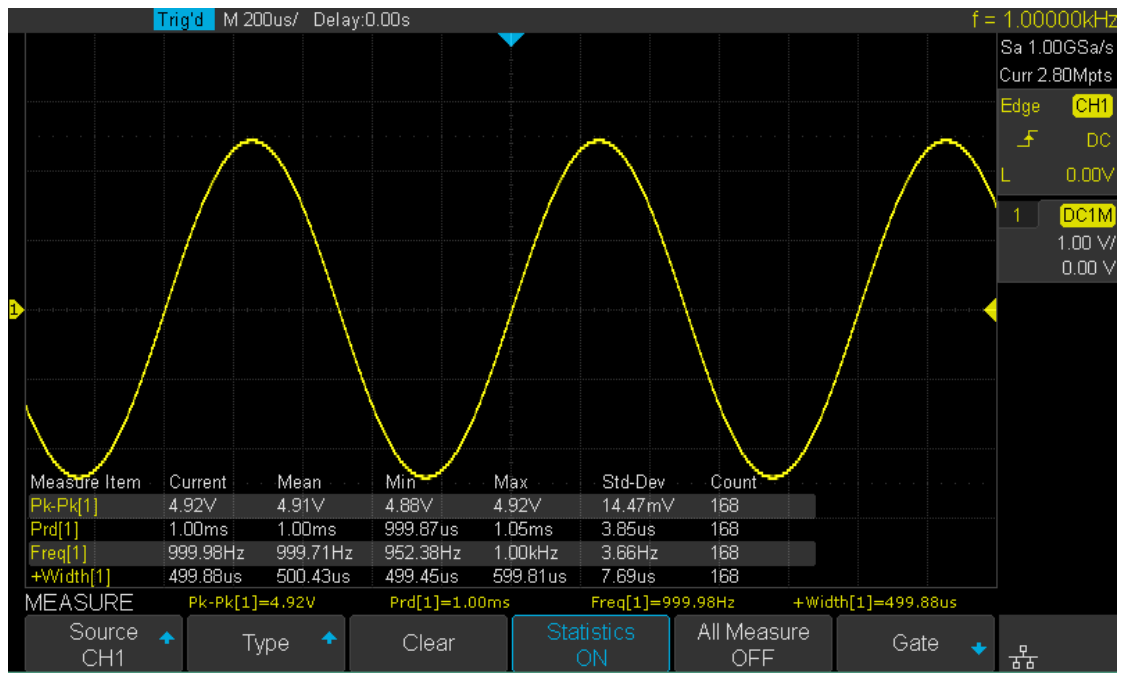

Figure 70 Added the Measurement

Note: if the parameter does not match the measure condition, it will display as "\*\*\*\*".

---

## Clear Measurement Parameters

Press the **Clear** softkey to clear all the measurement parameters that are displaying on the screen.

## To Make All Measurements

All measurements could measure all the voltage, time and delay parameters of the current measurement source and display the results on the screen.

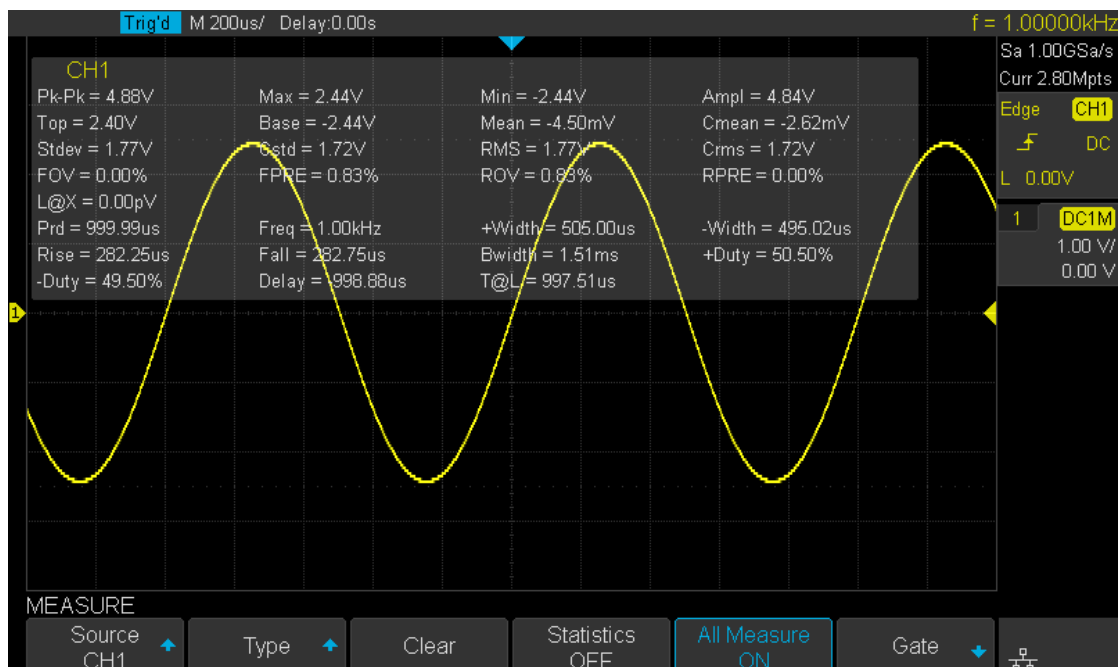

Figure 71 All Parameters Measurement

Do the following steps to make all parameters measurement.

1. Press the **Measure** button on the front panel to enter the MEASURE function menu.
2. Press the **All Measure** softkey to select **On**.
3. Press the **Source** softkey to select the measurement source.

---

# Display Setting

You can set the display type, color, persistence, grid type, waveform intensity, grid brightness and transparenance.

The contents of this chapter:

- ◆ To Set Display Type
- ◆ To Set Color Display
- ◆ To Set and Clear Persistence
- ◆ To Clear the Display
- ◆ To Select Grid Type
- ◆ To Adjust the Waveform Intensity
- ◆ To Adjust the Grid Brightness
- ◆ The Adjust the Transparenance

## To Set Display Type

Press the **Display** button on the front panel, and then press the **Type** softkey to select **Vectors** or **Dots** display type.

- **Vectors:** the sample points are connected by lines and displayed. Normally, this mode can provide the most vivid waveform to view the steep edge of a waveform (such as a square wave).
- **Dots:** displays only the sample points. You can directly view each sample point and use the cursor to measure the X and Y values of the sample points.

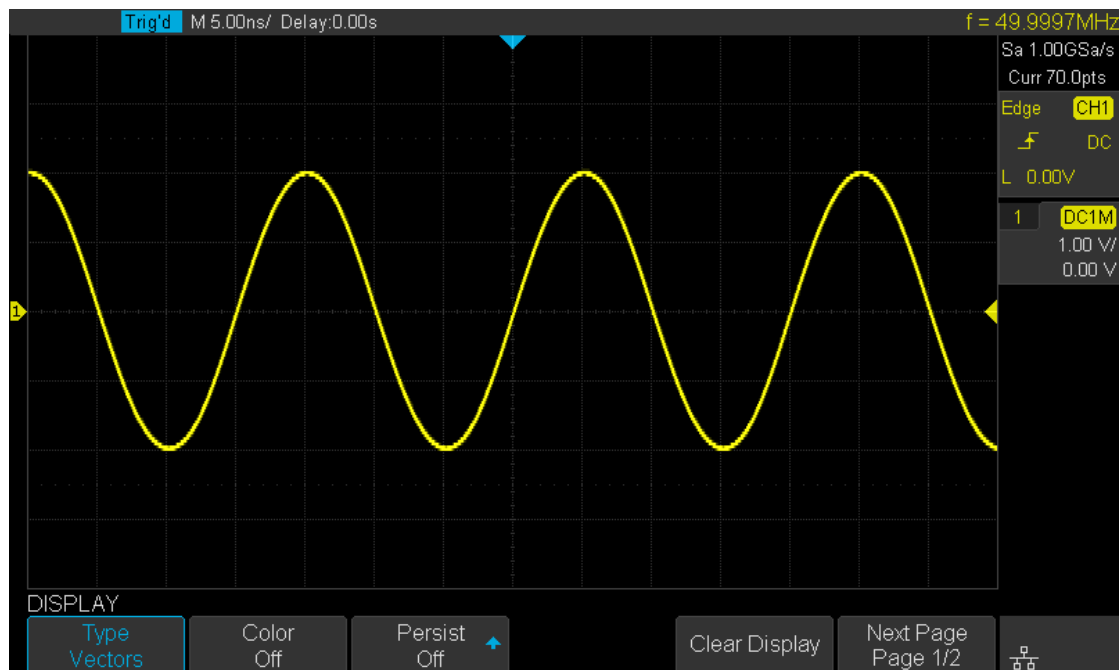

Figure 72 Vectors Display

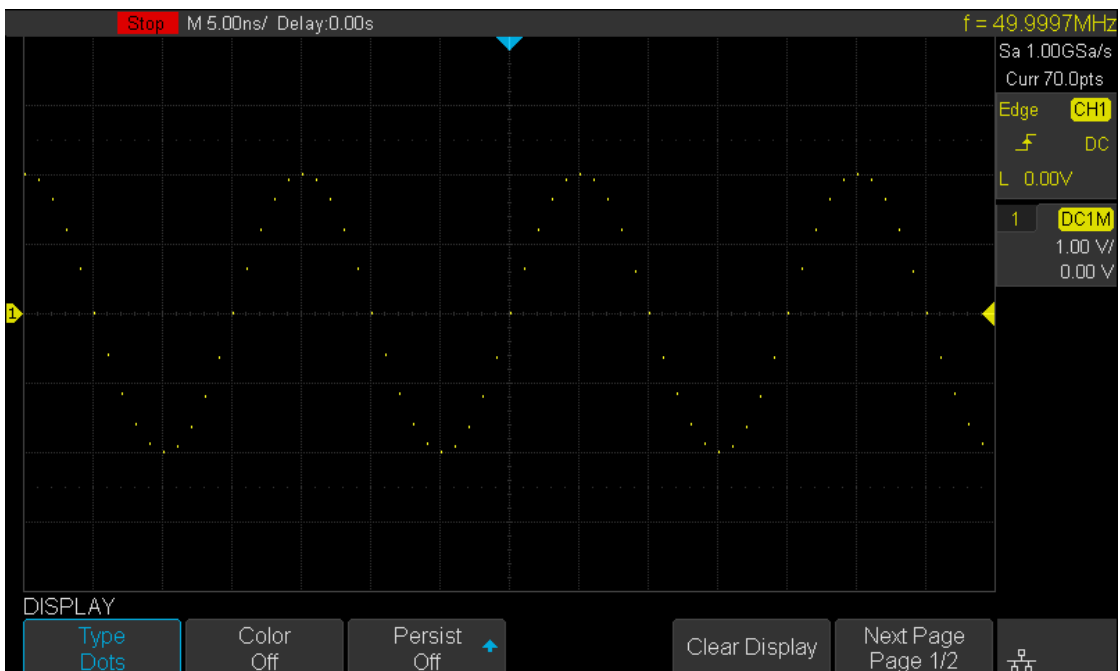

Figure 73 Dots Display

---

## Set Display Color Temperature

Color temperature adopts the change of waveforms' color to reflect the change of the waveforms' appearance. The more frequently that the waveform appears, the warmer the color is; the less frequent the waveform appears, the colder the color is.

The picture below shows the change of color from cold to warm. Press the Display button on the front panel, and then press the **Color** softkey and set the option to **On** to turn on the color temperature function. You can compare the waveform's color with the picture below to understand the frequency that the waveform appears.

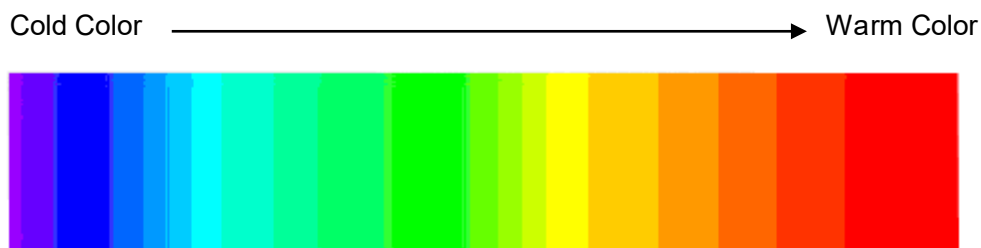

Figure 74 Color Temperature

## To Set and Clear Persistence

With persistence, the oscilloscope updates the display with new acquisitions, but does not immediately erase the results of previous acquisitions. All previous acquisitions are displayed with reduced intensity. New acquisitions are shown in their normal color with normal intensity.

Do the following steps to set and clear persistence:

1. Press the **Display/Persist** button on the front panel to enter the DISPLAY function menu.
2. Press the **Persist** softkey; then turn the **Universal Knob** to select the desired option.
  - **Off** —turn off persistence.
  - Variable persistence time (1 second, 5 seconds, 10 seconds, 30 seconds ) — select appropriate persistence time, the results of previous acquisitions are erased after the persistence time.
  - **Infinite** —select “Infinite”. Results of previous acquisitions are never erased. Use infinite persistence to measure noise and jitter, to see the worst- case extremes of varying waveforms, to look for timing violations, or to capture events that occur infrequently.



Figure 75 Persist Set to Infinite

3. When the **Persist** is **On**, to erase the results of previous acquisitions from the display, press the **Clear Persist** softkey. The oscilloscope will start to accumulate acquisitions again.
4. To return to the normal display mode, turn off persist and the previous acquisitions will be clear at once.

## To clear the display

Press the Display button on the front panel to enter the DISPLAY function menu; press the **Clear Display** softkey to clear all the waveforms displaying on the screen and acquire new waveforms.

---

## To Select Grid Type

To select grid type

1. Press the **Display/Persist** button on the front panel to enter the DISPLAY function menu.
2. Press the **Next Page** softkey to go to the second page of the Display function menu.
3. Press the **Grid** softkey; and then turn the **Universal Knob** to select the desired grid type. Press the **Grid** softkey continually can also select the grid type.

There are 3 kinds of grid types that are available. Select the grid type according to your needs.



Display 14X8 grid type



Display 2X2 grid type



Display without grid

## To Adjust Waveform Intensity

Do the following steps to adjust waveform intensity:

1. Press the **Display/Persist** button on the front panel to enter the DISPLAY function menu.
2. Press the **Next Page** softkey to go to the second page of the Display function menu.
3. Press the **Intensity** softkey; and then turn the **Universal Knob** to select the desired value. The default value is 50%, and the range is from 0% to 100%.

Increasing the intensity lets you see the maximum amount of noise and infrequently occurring events. Reducing the intensity can expose more detail in complex signals.

Note: Waveform intensity adjustment affects analog channel waveforms only (not math waveforms, reference waveforms, digital waveforms, etc.).



---

## To Adjust Grid Brightness

Do the following steps to adjust the grid brightness:

1. Press the **Display** button on the front panel to enter the DISPLAY function menu.
2. Press the **Next Page** softkey to go to the second page of the Display function menu.
3. Press the **Graticule** softkey; and then turn the **Universal Knob** to select the desired value. The default value is 40%, and the range is from 0% to 100%.

## To Adjust Transparency

Transparency can be used to adjust the transparency of the message box of cursor, measure, Pass/Fail and all pop-up menus to an appropriate value to observe the data more conveniently.

Under Cursor or Measure or any other menu operation, if you want to change the transparency of the message box, do the following steps:

1. Press the **Display** button on the front panel to enter the DISPLAY function menu.
2. Press the **Next Page** softkey to go to the second page of the Display function menu.
3. Press the **Transparence** softkey; and then turn the **Universal Knob** to select the desired value. The default value is 80%, and the range is from 20% to 80%.

---

# Save and Recall

Oscilloscope setups, waveforms, pictures, and CSV files can be saved to internal oscilloscope memory or to a USB storage device. The saved setups or waveforms can be recalled later. The oscilloscope provides a USB Host interface on the front panel to connect a USB device for external storage.

The contents of this chapter

- ◆ Save Type
- ◆ Internal Save and Recall
- ◆ External Save and Recall
- ◆ Disk Management

---

## Save Type

The oscilloscope supports setups, waveforms, pictures and CSV files storage. The default save type is setups.

### 1. Setups

It's the default storage type of the oscilloscope. It saves the settings of the oscilloscope in internal or external memory in "\*.SET" format. At most 20 setting files (from No.1~No.20) can be stored in internal memory. The stored settings can be recalled.

### 2. Reference

The oscilloscope saves the waveform data in external memory in "\*.REF" format. At recall, the data will be displayed on the screen as REFA or REFB.

### 3. BMP

The oscilloscope saves the screen image to external memory in "\*.bmp" format. You can specify the file name and saving directory under the same directory using the same file name. The recall of image the is not supported. The image is for use on an external PC.

### 4. JPG

The oscilloscope saves the screen image to external memory in "\*.jpg" format. You can specify the file name and saving directory under the same directory using the same file name. The recall of the image is not supported. The image is for use on an external PC.

### 5. PNG

The oscilloscope saves the screen image to external memory in "\*.png" format. You can specify the file name and saving directory under the same directory using the same file name. The recall of image is not supported. The image is for use on an external PC.

### 6. Binary

The oscilloscope saves the waveform data to external memory in "\*.BIN" format. The data of all the channels turned on can be saved in the same file. The recall of binary data is not supported. The binary data file is for use on an external PC.

### 7. CSV

The oscilloscope saves the waveform data to external memory in "\*.CSV" format. The stored files contain the waveform data of the displayed analog channels and the main setting information of the oscilloscope. The recall of CSV file is not supported. The CSV file is for use on an external PC.

Set the save type to **CSV**, and set the **Para Save** option to **On** or **Off** to turn on or of the parameters storage function.

---

## **8. Matlab**

The oscilloscope saves the waveform data to external memory in “.DAT” format. The data of all the channels turned on can be saved in the same file. The recall of Matlab file is not Supported. The data file is for use on an external PC.

## **9. The Default Key**

The oscilloscope saves the factory config and config set by the user. Then you can recall the default factory config or user config.

---

## Internal Save and Recall

Internal save and recall supports Setups in **Save/Recall**. In the following part, the save and recall method and procedures are introduced.

➤ **Save the specified oscilloscope setting in internal memory.**

1. Connect the signal to the oscilloscope and obtain a stable display.
2. Press **Save/Recall** button on the front panel to enter the SAVE/RECALL function menu.
3. Press the **Type** softkey and then turn the **Universal Knob** to select **Setups**; and then press the knob to confirm.
4. Press the **Save To** softkey to select **Internal** to save the current setup of the oscilloscope to the internal memory.
5. Press the **Setup** softkey button; and then turn the **Universal Knob** to select the location to save. The internal memory can save as many as 20 setup files, from No.1~No.20.
6. Press the **Save** softkey to save the current setup to the appointed location. After a few seconds the message “**Store Data success!**” will appear.

➤ **Load the specified type of file to internal memory.**

If you want to recall the setup after having finished the steps above, please do the following steps:

Press the **Setup** softkey, and then turn the **Universal Knob** to select the location that you want to recall, press the **Recall** softkey to recall the setup, and it will pop-up the message “**Read Data Success!**”

Note: if you need to delete a setup file in the memory, please save a new setup to the same location to overwrite it.

---

## External save and recall

Before using external storage and recall, make sure that the USB flash device is connected correctly. External storage supports all the types of files in save, but in recall, **Picture** and **CSV** are not supported.

➤ **Save the specified type of file in the external USB flash device.**

1. Press the **Save/Recall** button on the front panel to enter the SAVE/RECALL function menu.
2. Press the **Type** softkey to select **Reference** or **Setup**
3. Press the **Recall** softkey to enter the SAVE/RECALL file system.

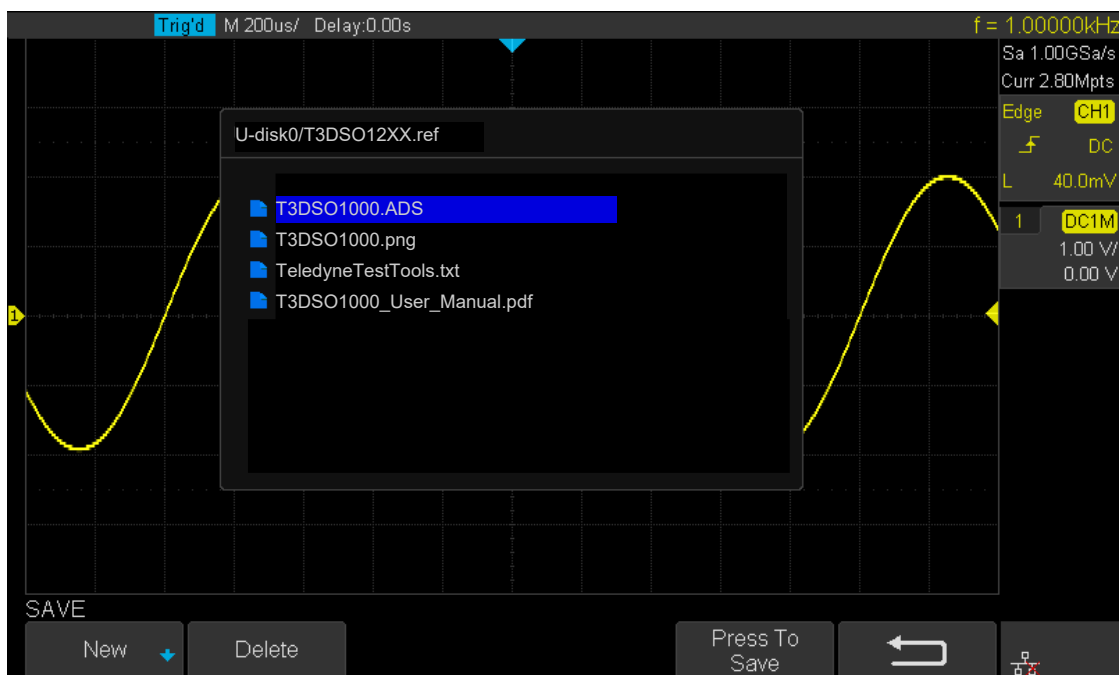

Figure 76 SAVE/RECALL File System

4. Use the **Universal Knob** to select the desired location. Files can be stored under the root directory or in a certain folder under the root directory of the USB storage device.

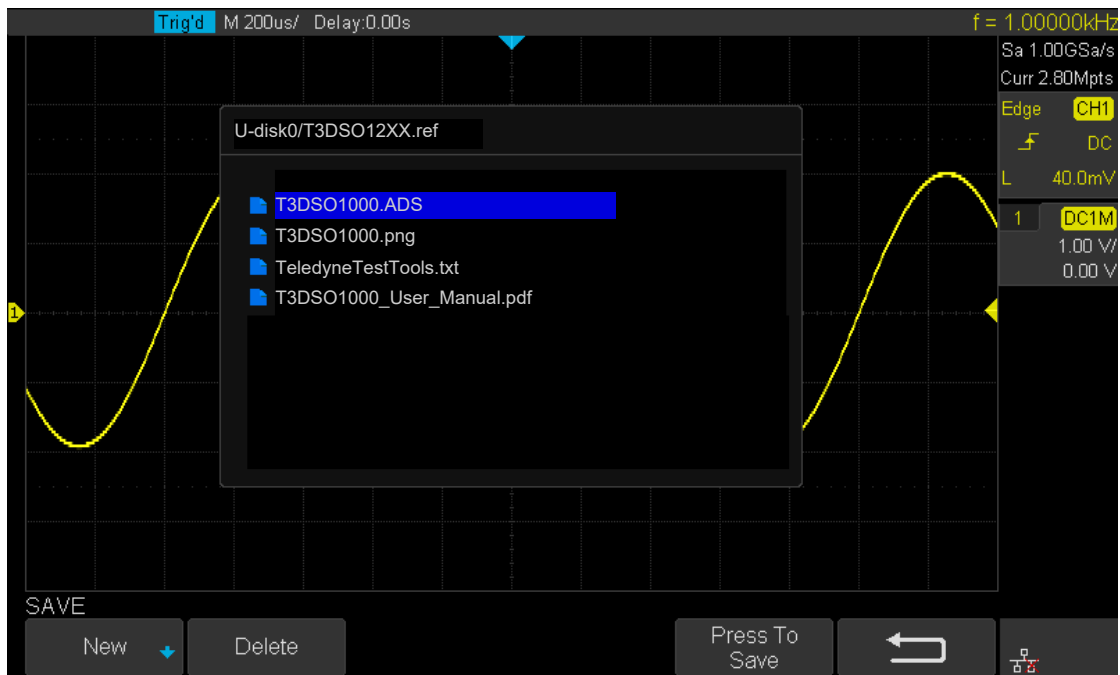

Figure 77 Select Save Location

5. After the save position is selected, press the **New** softkey to turn on the interface as shown in the figure below. Refer to the descriptions in **“To Create a new file or fold”** to create a new file name.

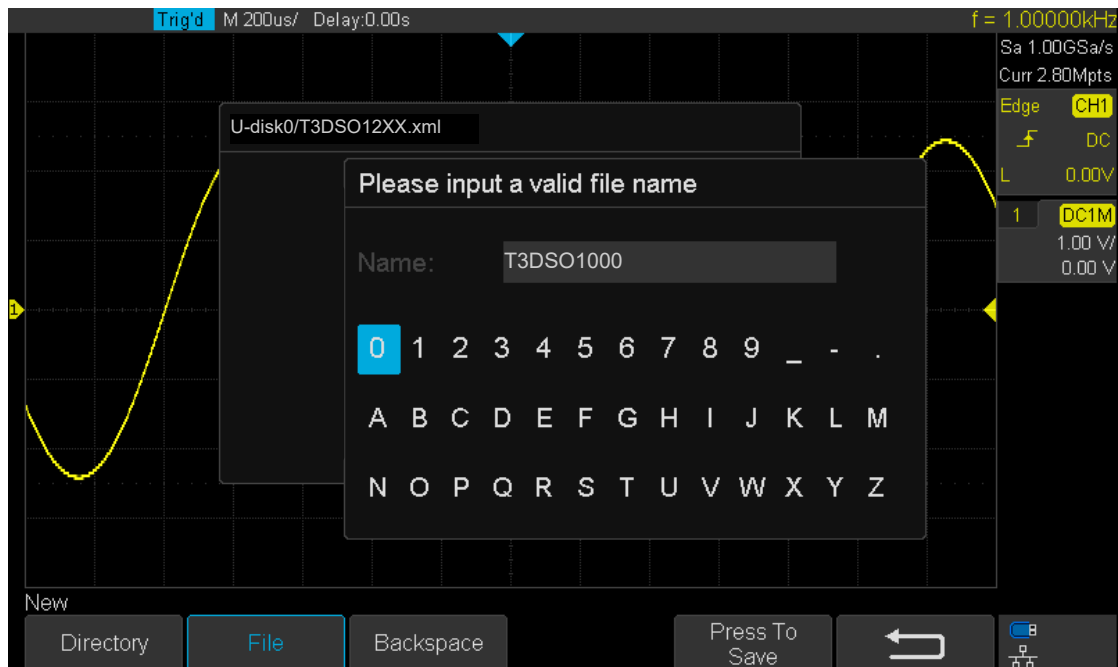

Figure 78 File Name Dialogue

6. Press the Enter softkey to save the current waveform to the external USB storage Device.

- 
- **Load the specified type of file in the external USB storage device.**
7. Press the **Save/Recall** button on the front panel to enter the SAVE/RECALL function menu.
  8. Press the **Type** softkey to select **Waveforms** or **Setup**
  9. Press the **Recall** softkey to enter the SAVE/RECALL file system.
  10. Turn the **Universal Knob** to select the file to be recalled, press the **Load** softkey to recall the waveform or setup.



---

## Disk Management

Disk management manages the save and recall operations once the oscilloscope is connected to a USB storage device. Before using USB storage, make sure that the USB storage device is connected correctly.

Execute the following operations through the disk management menu:

- ◆ To Create a New File or Folder
- ◆ To Delete a File or Folder
- ◆ To Rename a File or Folder

---

## To Create a New File or Folder

This operation is only valid with external storage. The oscilloscope supports English. The file name or folder name can contain letters, numbers, underscores and spaces. Let's use an example to introduce how to create a file or folder.

Example: create a file or folder named "T3DSOab"

1. Press the **Save/Recall** button on the front to enter the SAVE/RECALL function menu.
2. Press the **Save** softkey, and then turn the **Universal Knob** to select one of the type (if select **Setups**, please set the **Save To** option to **External**).
3. Press the **Save** softkey to enter the SAVE/RECAL file system.  
Press the **New** softkey to open the interface shown as the picture below. It divides into two parts: name input area and keyboard area.

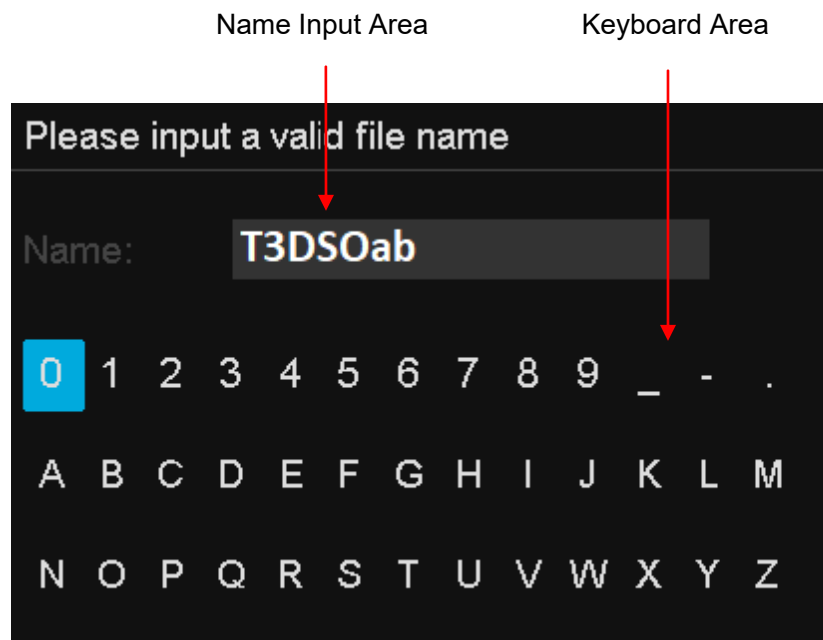

Figure 79 Input Keyboard

4. To delete the name in the name input area, press the **Backspace** softkey continuously to delete the characters one by one.

---

## To delete a file or folder

This operation is only valid for external storage.

1. Press the **Save/Recall** button on the front to enter the SAVE/RECALL function menu.
2. Press the **Save** softkey, and then turn the **Universal Knob** to select one (if select Setups, please set the **Save To** option to **External**).
3. Press the **Save** or **Recall** softkey to enter the SAVE/RECAL file system.
4. Turn the **Universal Knob** to select the file or folder to be deleted, and then press the **Delete** softkey. Then the file or folder will be deleted.

---

# Digital Channels(Optional)

This chapter describes how to use the digital channels of a Mixed-Single Oscilloscope (MSO).

The digital channels are available on the 4-channel oscilloscopes that have the MSO activation license installed.

This chapter contains the following items:

- ◆ To Connect the Digital Probes to the Device-under-test
- ◆ Acquiring Waveforms Using the Digital Channels
- ◆ To Change the Display Type of the Digital Channels
- ◆ To Switch a Single Channel On or Off
- ◆ To Switch All Digital Channels On or Off
- ◆ To Change the Logic Threshold for Digital Channels
- ◆ To Reposition a Digital Channel
- ◆ To Display Digital Channels as a Bus

---

## To Connect the Digital Probes to the Device-under-test

1. If necessary, turn off the power supply to the device-under-test.
  - Turning off the power to the device-under-test prevents damage that might occur if you accidentally short lines together while connecting probes. You can leave the oscilloscope powered on because no voltage appears at the probes.
2. Connect one of the digital probe cable ports to the digital channels connector on the front panel of the T3DSO1000, and the other end to the digital channels connector of the digital probe.
  - The digital probe cable is keyed so you can connect it only one way. You do not need to power-off the oscilloscope.
3. Connect a flying lead to one of the digital probe ground pins, connect a grabber to the flying lead, and then connect the grabber to a ground trace/pin from the device-under-test.

The ground lead improves signal fidelity to the oscilloscope, ensuring accurate Measurements. It's good practice to connect several ground leads.
4. Connect a flying lead to one of the digital probe digital channel pins; connect a grabber to the flying lead, and then connect the grabber to a node in the circuit that you want to test.
5. Repeat step 4 until you have connected all points of interest.

---

## Acquiring Waveforms Using the Digital Channels

Press the **Digital** button on the front panel to open the digital channels and start acquiring digital channel waveforms.

For digital channels, each time the oscilloscope takes a sample it compares the input voltage to the logic threshold. If the voltage is above the threshold, the oscilloscope stores a 1 in the sample memory; otherwise, it stores a 0.

## To Change the Display Type of the Digital Channels

1. Press the **Digital** button on the front panel to open the DIGITAL function menu.

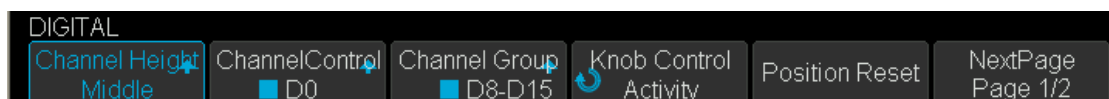

Figure 80 Digital Function Menu

2. Press the **Channel High** softkey to select **Low,Middle,High** display type.

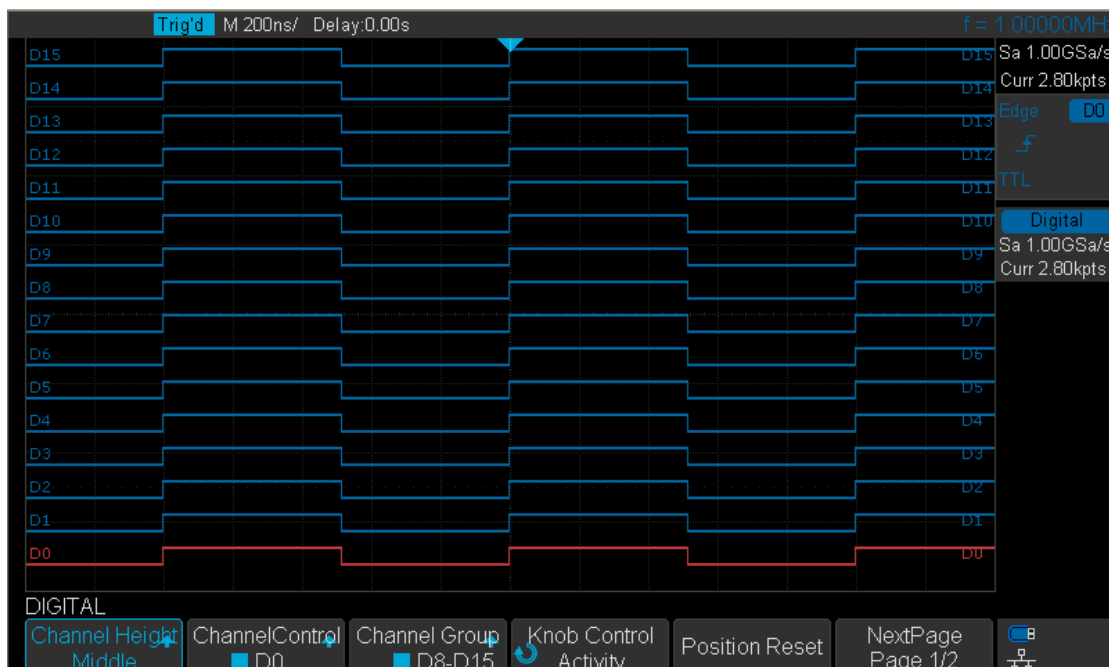

Figure 81 Digital Channel Height

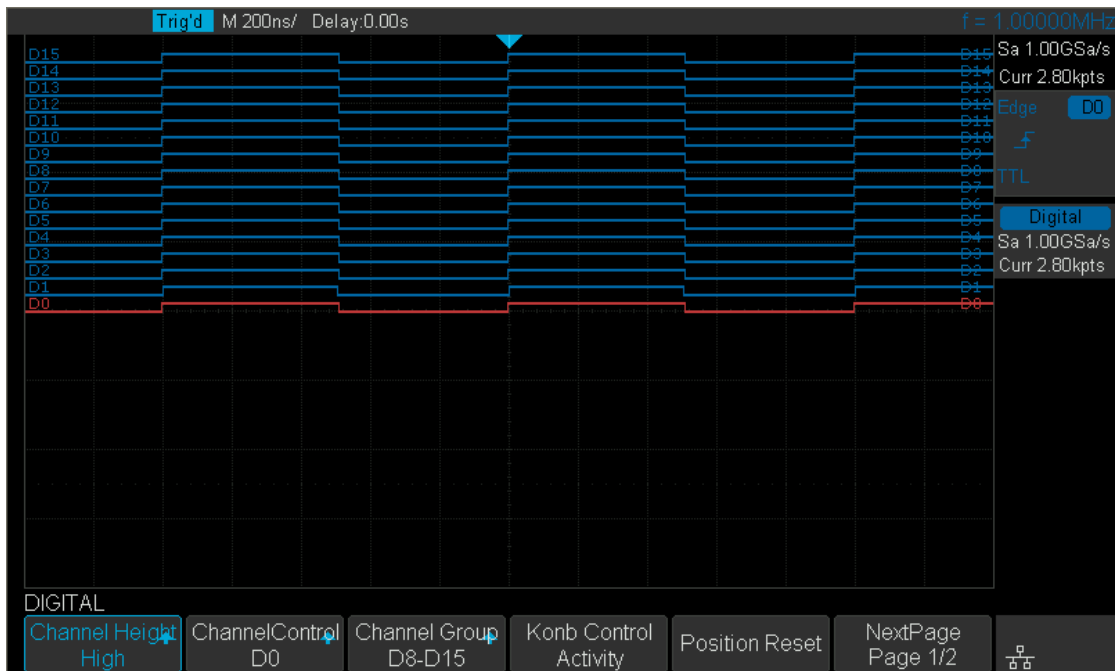

Figure 82 High Display Type

The display type control lets you spread out or compress the digital traces vertically on the display for more convenient viewing.

## To Switch a Single Channel On or Off

1. Press the **Digital** button on the front panel to open the DIGITAL function menu.
2. Press the **ChannelControl** softkey, then turn the Universal Knob to select the desired channel such as **Dx** and push down the knob to confirm.
3. Press the **Dx** softkey to select **On** or **Off** to switch the selected channel on or off.

## To Switch All Digital Channels On or Off

1. Press the **Digital** button on the front panel to open the DIGITAL function menu.
2. Press the **ChannelGroup** softkey to select **On** or **Off** to switch all digital channels in this group on or off.
  - Also, under the DIGITAL function menu, press the **Digital** button on the front panel to switch all digital channels off.

---

## To Change the Logic Threshold for Digital Channels

1. Press the **Digital** button on the front panel to open the DIGITAL function menu.
2. Press the **Threshold** softkey to enter the THRESHOLDS menu.
3. Press the **D0~D7** or **D8~D15** softkey, then turn the **Universal Knob** to select a logic family preset or select Custom to define your own threshold.

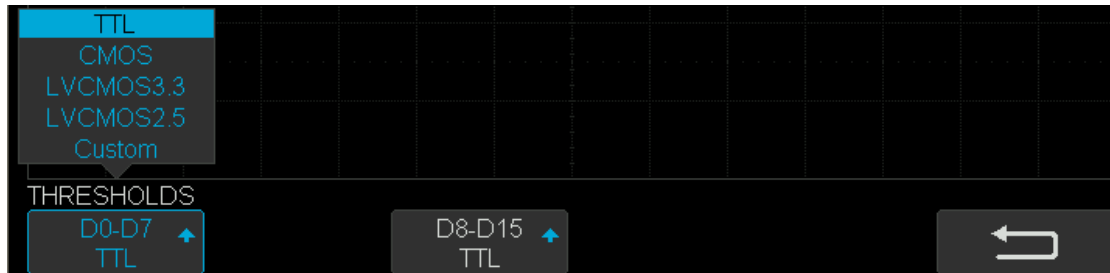

Figure 83 THRESHOLDS Function Menu

Logic Family	Threshold Voltage
TTL	1.5V
CMOS	1.65V
LVCMOS3.3	1.65V
LVCMOS2.5	1.25V
Custom	Variable from -3V to +3V

- The threshold you set applies to all channels.
- Values greater than the set threshold are high (1) and values less than the set threshold are low (0).
- If the **D0~D7** or **D8~D15** softkey is set to **Custom**, press the **Custom** softkey, then turn the **Universal Knob** to select the desired value and push the knob to confirm.

## To Reposition a Digital Channel

1. Press the **Digital** button on the front panel to open the DIGITAL function menu and display the digital channel waveforms.
2. Press the **knob control softkey** then turn the **Universal Knob** to select the channel that you wish to reposition. The selected waveform is highlighted in red.
3. Turn the **Universal Knob** to move the selected channel position.



## To Display Digital Channels as a Bus

Digital channels may be grouped and displayed as a bus, with each value displayed at the bottom of the display in hex or binary. You can create up to two buses.

To configure and display each bus, do the following steps:

1. Press the **Digital** button on the front panel to open the DIGITAL function menu and display the digital channel waveforms.
2. Press the **Digital Bus** softkey to enter the DIGITALBUS function menu.



Figure 84 DIGITALBUS Function Menu

3. Press the **Bus Select** softkey to select **Bus1** or **Bus 2**.
4. Press the **Display** softkey to select **On** to display the bus at the bottom of the display.
  - Under the DIGITAL function menu, press the **ChannelControl** softkey, turn the **Universal Knob** to make a selection such as **DX**, and then press the **Dx** softkey to select **On** or **Off** to set the channel to be included or excluded from the bus.
  - Under the DIGITAL function menu, press the **ChannelGroup** softkey to select **On** or **Off** to include or exclude all digital channels in this group.
  - Under the DIGITAL function menu, a status indicator is displayed in the status line at the bottom of the display. Light blue shows the digital channel is included in the bus while black shows it is excluded from the bus.
  - Under the DIGITAL function menu, press the **System Display** softkey to select **Binary** or **Hex** to display the bus values.
  - The Sampling rate of digital channels is displayed at the right of the display.

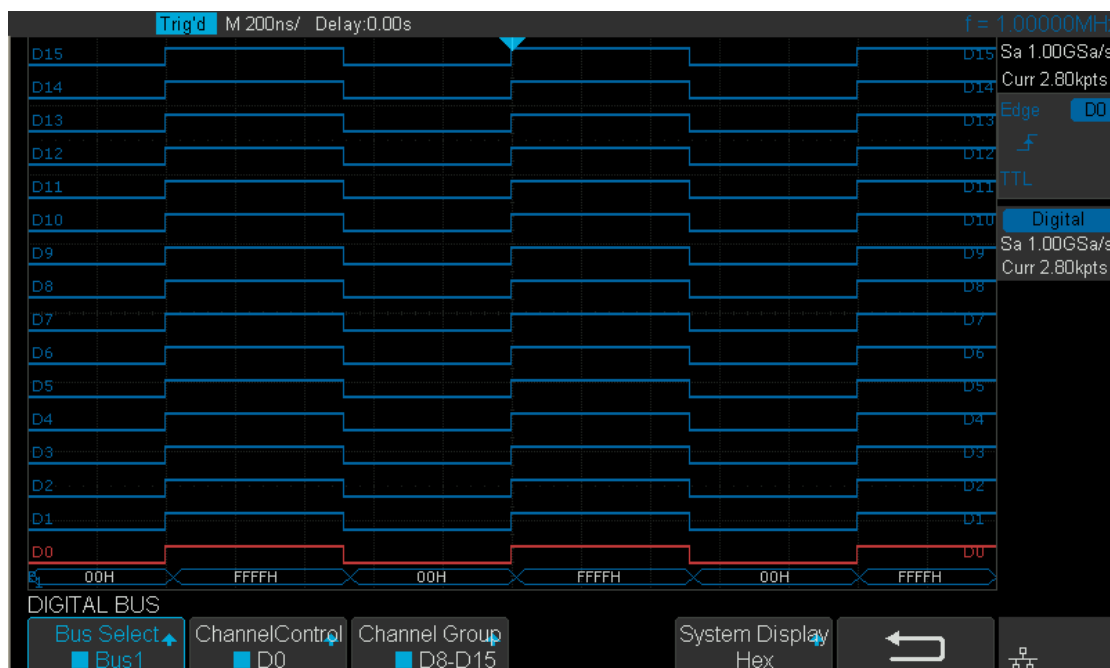

Figure 85 Digital Bus

---

# System Function Setting

This function module supports the oscilloscope's system-related functions, such as system status, language, sound and some other advanced settings, such as self cal, update and remote interface configure.

The contents of this chapter:

- ◆ To View the System Status
- ◆ To Do Self Calibration
- ◆ IO Set
- ◆ To Enable or Disable the Sound
- ◆ To Specify the Language
- ◆ To do Pass/Fail Test
- ◆ To Use the History Function
- ◆ To Print the Screen Image
- ◆ To Update Firmware or configuration
- ◆ To Do self Test
- ◆ To Specify the Screen Saver Time

---

## To View the System Status

Do the following steps to view the system status:

1. Press the **Utility** button on the front to enter the UTILITY function menu.
2. Press the **System Status** softkey to view the system status of the oscilloscope. The system status includes the information below:
  - **Startup Times:** record the boot-strap times of the oscilloscope.
  - **Software Version:** list the current software version of the oscilloscope.
  - **Fpga Version:** list the current fpga version of the oscilloscope.
  - **Hardware Version:** list the current hardware version of the oscilloscope.
  - **Product Type:** display the product type of the oscilloscope.
  - **Serial NO.:** list the serial number of the oscilloscope.
  - **Scope ID:** display the scope identification of the oscilloscope.



Figure 86 System Status

3. Press the **Single** button on the front panel to exit.

---

## To Do Self Calibration

The self-calibration program can quickly make the oscilloscope reach the best working state to get the most precise measurement values. You can perform self-calibration at any time especially when the environment temperature changes by more than 5 °C. Make sure that the oscilloscope has been warmed up or operated for more than 30 minutes before the self-calibration.

Do the following steps to do self calibration:

1. Disconnect all the input channels.
2. Press the **Utility** button on the front panel, and then press the **Do Self Cal** softkey, and the oscilloscope will show the message box shown as below:

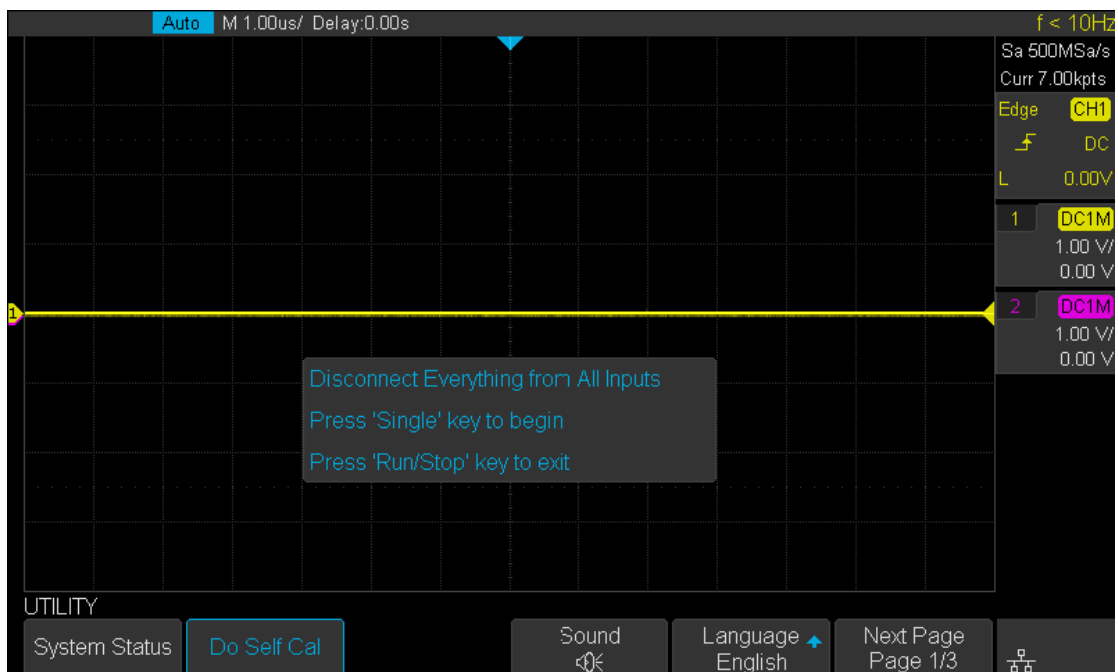



Figure 87 Do Self Cal

3. Press the **Single** button on the front panel to perform the self calibration program. During the calibration, most of the keys are disabled.
4. When the self calibration program is finished, it will display the message “**press Run/Stop key to exit**”. Press the **Run/Stop** button on the front panel to exit the calibration interface.

---

## To Enable or Disable the Sound

When the sound is enabled, you can hear the sound of the beeper when you press a function key or a menu softkey or when the prompt message pops up.

Press the **Utility** button on the front panel to enter the UTILITY function menu; then press **Sound** softkey to select  or  to turn on or off the sound.

## To Specify the Language

The oscilloscope supports multiple language menu, Chinese/English help and prompt messages.

1. Press **Utility** button on the front panel to enter the UTILITY Function menu.
2. Press the **Language** softkey; and then turn the **Universal Knob** to select the desired language. Then push the knob to select the language.

The languages that are currently available are Simplified Chinese, Traditional Chinese, English, French, German, Spanish, Russian, Italian, and Portuguese.

---

## Pass/Fail Testing

One way to verify a waveform's compliance to a particular set of parameters is to use pass/fail testing. A pass/fail defines a region of the oscilloscope's display in which the waveform must remain in order to comply with chosen parameters. Compliance to the mask is verified point- by- point across the display.

The test results can be displayed on the screen as well as be indicated through the system sound or the pulse signal output from the **[TRIG OUT]** connector at the rear panel. Pass/Fail test operates on displayed analog channels; it does not operate on channels that are not displayed.

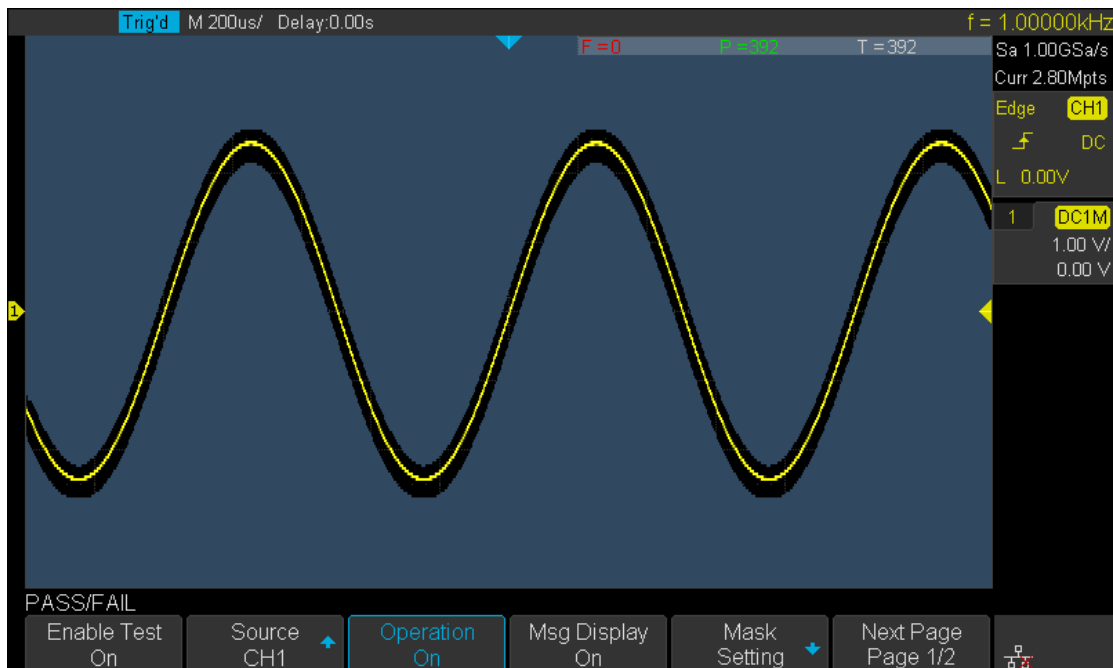

Figure 88 Pass/Fail Test





---

## To Set and Perform Pass/Fail Test

Do the following steps to set and perform pass/fail test:

1. Press the **Utility** button on the front panel to enter the UTILITY function menu.
2. Press the **Next Page** softkey to go to the second page of the UTILITY function menu.
3. Press the **Pass/Fail** softkey to enter the PASS/FAIL function menu.
4. Press the **Enable Test** softkey to select **On** to enable the pass/ fail test.
5. Press the **Source** softkey to select the desired channel.
6. Press the **Mask Setting** softkey to enter the MASK function menu.
7. Press the **X Mask** or **Y Mask** softkey; and then turn the **Universal Knob** to select the desired value. The range is from 0.02div to 4div.
8. Press the **Create Mask** button to create the mask. Whenever the **Create Mask** softkey is pressed the old mask is erased and a new mask is created.
9. Press the **UP** softkey to return to the PASS/FAIL function menu.
10. Press the **Msg Display** to select **On** or **Off** to turn on or off the message display. When **On** is selected, the test result will be displayed in the upper-right message box of the screen.

**F = 271**      **P = 324**      **T = 615**

- **Fail:** the number of waveforms that failed to match the mask (mask violation).
  - **Pass:** the number of waveforms within the mask.
  - **Total:** the total number of waveforms that have been acquired. The total of **Pass** and **Fail**.
11. Press the Next Page softkey to go to the second page of the PASS/FAIL function menu.
  12. Press the Fail softkey to select On or Off to turn on or off the function.
    - **On:** when failed waveforms are detected, the oscilloscope will stop the test and enter the STOP state. At this point, the results of the test remain on the screen (if the screen is turned on) and only one pulse is output from the **[TRIG OUT]** connector (if enabled) on the rear panel.
    - **Off:** the oscilloscope will continue with the test even though failed waveforms are detected. The test results on the screen will update continuously and a pulse will be output from the **[Trigger Out]** connector at the rear panel each time a failed waveform is detected.
  13. Press the Output softkey to turn on or off the sound.
    -  : When the failed waveforms are detected, the beeper sounds.
    -  : The beeper will not sound even if the failed waveforms are detected.
  14. Press the Next Page softkey to return to the first page of the PASS/FAIL function menu.
  15. Press the Operate softkey to perform the test.
    -  : Current state is stop; press the softkey to start the pass/fail test.
    -  : Current state is running; press the softkey to stop the pass/fail test.

---

## Save and Recall Test Masks

Users can save the current test mask to the internal Flash memory or external USB flash device. The file format of the test mask file is “\*.RGU”.

### Save Test Mask to Internal Memory

1. Press the **Utility** button on the front panel to enter the UTILITY function menu.
2. Press the **Next Page** softkey to go to the second page of the UTILITY function menu.
3. Press the **Pass/Fail** softkey to enter the PASS/FAIL function menu.
4. Press the **Enable Test** softkey to select **On** to enable the pass/ fail test.
5. Press the **Source** softkey to select the desired channel.
6. Press the **Mask Setting** softkey to enter the MASK function menu.
7. Press the **X Mask** or **Y Mask** softkey; and then turn the **Universal Knob** to select the desired value.
8. Press the **Location** softkey to select **Internal**
9. Press the **Save** softkey to save the mask to internal memory.
10. A few second later the message “**Store Data Success!**” will be displayed.

Note: the internal memory can only save one test mask; saving a new test mask will erase the old one.

### Recall Test Mask from Internal Memory

1. Press the **Utility** button on the front panel to enter the UTILITY function menu.
2. Press the **Next Page** softkey to go to the second page of the UTILITY function menu.
3. Press the **Pass/Fail** softkey to enter the PASS/FAIL function menu.
4. Press the **Enable Test** softkey to select **On** to enable the pass/ fail test.
5. Press the **Mask Setting** softkey to enter the MASK function menu.
6. Press the **Location** softkey to select **Internal**.
7. Press the **Load** softkey to recall the saved interval memory.
8. A few second later the message “**Read Data Success!**” will be displayed and the saved mask will be displayed on the screen.



---

### Save Test Mask to External Memory

Do the following steps to save the test mask to external memory:

1. Press the **Utility** button on the front panel to enter the UTILITY function menu.
2. Press the **Next Page** softkey to go to the second page of the UTILITY function menu.
3. Press the **Pass/Fail** softkey to enter the PASS/FAIL function menu.
4. Press the **Enable Test** softkey to select **On** to enable the pass/ fail test.
5. Press the **Source** softkey to select the desired channel.
6. Press the **Mask Setting** softkey to enter the MASK function menu.
7. Press the **X Mask** or **Y Mask** softkey; and then turn the **Universal Knob** to select the desired value.
8. Press the **Location** softkey to select **External**
9. Press the **Save** softkey to enter the file SAVE/RECALL system.
10. Save the test mask file refer to the “**Save and Recall**” chapter.

### Recall Test Mask from External Memory

Do the following steps to save the test mask f external memory:

1. Press the **Utility** button on the front panel to enter the UTILITY function menu.
2. Press the **Next Page** softkey to go to the second page of the UTILITY function menu.
3. Press the **Pass/Fail** softkey to enter the PASS/FAIL function menu.
4. Press the **Enable Test** softkey to select **On** to enable the pass/ fail test.
5. Press the **Mask Setting** softkey to enter the MASK function menu.
6. Press the **Location** softkey to select **External**.
7. Press the **Load** softkey to enter the file SAVE/RECALL system.
8. Select the desired test mask file with a RGU postfix using the **Universal Knob**; and then press the **Load** softkey.

---

## Arbitrary Waveform Generator(Optional)

The T3DSO1000 supports an external Arbitrary Waveform Generator (AWG) ,which can easily and quickly provide multiple output waveforms for users. The AWG provides two kinds of waveforms: the standard waveform and the Arb. The Arb waveform consists of two types: the system's built-in waveforms and the stored waveforms.

Built-in waveforms are stored in the internal non-volatile memory. It includes: Common, Math , Engine, Window, Trigo. Users may also edit the arbitrary waveforms using a PC, or import the waveforms from a U disk that contains stored edited waveforms.

The contents of this chapter:

- ◆ AWG Menu introduction
- ◆ AWG Introduction to the waveform selection
- ◆ AWG function setting
- ◆ AWG System information
- ◆ AWG System status and firmware upgrade
- ◆ AWG Remove Device

## Output

Connect AWG with USB cable, and the oscilloscope interface indicates "AWG device connection success", Press the **Utility** → **Next Page4/4** → **AWG**, to enter the function menu interface of the AWG system as shown below, including: Output, Wave, Setting, System, Remove Device.



Figure 89 AWG Menu Interface

Press **Output** softkey to open or close the AWG output. When the output is on, the upper right corner of the oscilloscope interface will display the corresponding waveform frequency and amplitude information of AWG output wave.

## Setting a Standard Waveform

### 1. To set standard waveform, sine wave example.

Press the **Utility** → **Next Page4/4** → **AWG** → **Wave**, Rotate the Universal knob to the Sine wave. Then press the knob to select the interface shown as below:

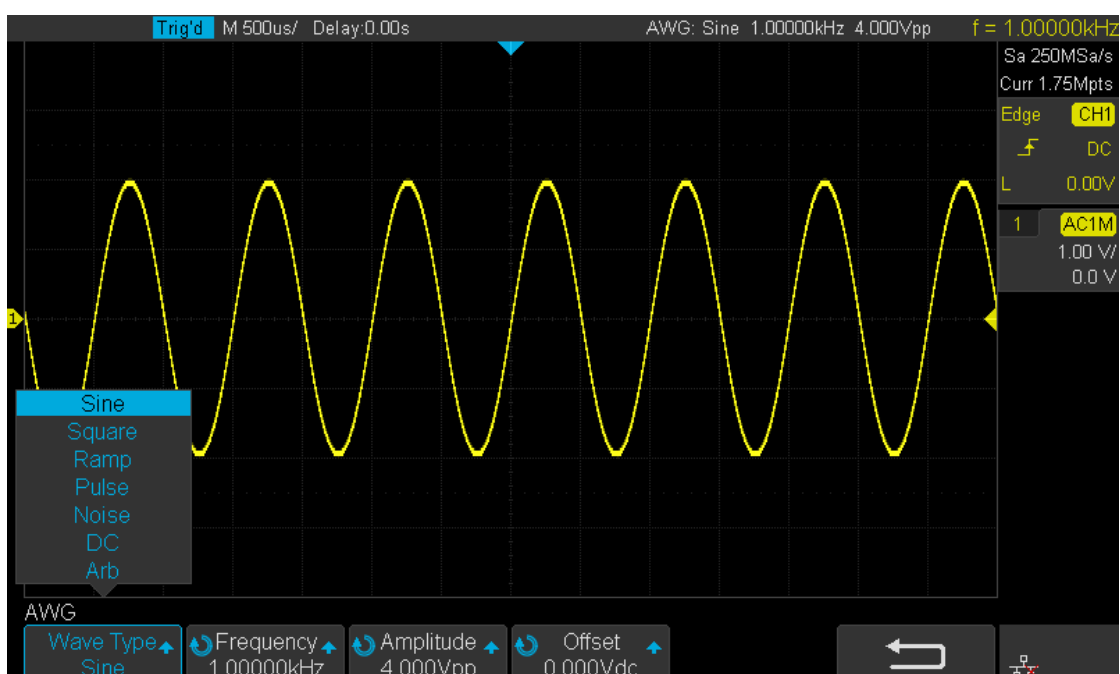

Figure 90 Wave Type Interface

- The following table shows the waveform type and its corresponding characteristics. Set the waveform parameters for the required waveform by using the universal knob and the menu system.

Type	Character	Frequency Range	Amplitude (High-Z)	Offset (High-Z)
Sine	Use the <b>Universal Knob</b> to adjust the Frequency/ Frequency Fine/ Period/ Period Fine/ Amplitude/ Amplitude Fine/ High-Level/ High-Level-Fine/ Offset/ Offset Fine/ Low-Level/ Low-Level-Fine value.	1uHz~25MHz	4mV~6V	± 3.0V
Square	Use the <b>Universal Knob</b> to adjust the Frequency/ Frequency Fine/ Period/ Period /Fine/ Amplitude/ Amplitude Fine/ High-Level/ High-Level-Fine/ Offset/ Offset Fine/ Low-Level/ Low-Level-Fine/ Duty value.	1uHz~10MHz	4mV~6V	± 3.0V
Ramp	Use the <b>Universal Knob</b> to adjust the Frequency/ Frequency Fine/ Period/ Period Fine/ Amplitude/ Amplitude Fine/ High-Level/ High-Level-Fine/ Offset/ Offset Fine/ Low-Level/ Low-Level-Fine/ Symmetry value.	1uHz~300KHz	4mV~6V	± 3.0V
Pulse	Use the <b>Universal Knob</b> to adjust the Frequency/ Frequency Fine/ Period/ Period /Fine/ Amplitude/ Amplitude Fine/ High-Level/ High-Level-Fine/ Offset/Offset Fine/ Low-Level/ Low-Level-Fine/ Width/ Width Fine value.	1uHz~10MHz	4mV~6V	± 3.0V
Noise	Use the <b>Universal Knob</b> to adjust the Stdev/ Mean value.			
DC	Use the <b>Universal Knob</b> to adjust the Offset value.			± 3.0V
Arb	Use the <b>Universal Knob</b> to adjust the Frequency/ Frequency Fine/ Period/ Period Fine/ Amplitude/ Amplitude Fine/ High-Level/ High-Level-Fine/ Offset/ Offset Fine/ Low-Level/ Low-Level-Fine value.			

### 3. How to setup an Arb waveform

Press the **Utility** → **Next Page4/4** → **AWG** → **Wave** then select the Arb, and it has two types:

#### Stored Arb:

Users can edit the Arb through a PC. Download the edited Arb to the instrument through the remote interface, or read from the U disk which has stored the Arb. Choose **Wave Type** → **Arb** → **Arb Type** → **Stored**, enter the Stored Arb interface and invoke the waveform in the external storage device.

#### Built\_in Arb:

Choose **Wave Type** → **Arb** → **Arb Type** → **Built-in** to enter the following interface, Rotate the knob to move the cursor, press the knob to select to the desired waveform, and then return back to the Built-in waveform interface.



Figure 91 Built\_in Arb interface

## Setting



Figure 92 AWG Setting Interface

### 1. Output Load

Press **Utility** → **NextPage4/4** → **AWG** → **Setting** → **Output Load** to set **High-Z** or **50Ω**.

---

## 2. Sync Output

Press **Utility** → **NextPage4/4** → **AWG** → **Setting** → **Sync Output**, the AWG provides Sync output through the [Aux In/Out] connector on the rear panel. When the Sync Output is on, the port can output a CMOS signal with the same frequency as basic waveforms (except the Noise and DC), arbitrary waveforms, and modulated waveforms (except external modulation).

## 3. OVP(over voltage protection)

Press **Utility** → **NextPage4/4** → **AWG** → **Setting** → **OVP** to turn on or off the function. If the state is set to ON, overvoltage protection of AWG output port take effect once the condition is met (the absolute value of input voltage is higher than  $4V \pm 0.5V$ ). When overvoltage protection occurs, a message will be displayed and the output is disabled.

## 4. Default

Press **Utility** → **NextPage4/4** → **AWG** → **Setting** → **Default** to recover the default values of the AWG (Sine, 1.000 KHz, 4.000Vpp, 0.0mVdc, High\_Z, Sync output off, OVP On).

## 5. Zero Adjust

Press **Utility** → **NextPage4/4** → **AWG** → **Setting** → **Zero Adjust**. The AWG can be calibrated by using **Auto** mode or **Manual** mode. The method of AWG calibration is covered below.

### Auto mode:

This mode can only be performed with the oscilloscope channel1. Connect the output of the AWG to the oscilloscope's channel1, press the Auto soft key, then the AWG starts automatic calibration, and displays "Zero Adjust Success!"

### Manual mode:

The AWG can be manually calibrated through any channel on the oscilloscope. Take channel 2 as an example.

Connect the output of AWG to the oscilloscope's channel 2, turn on channel 2, and set DC coupling, no bandwidth limit, Probe is 1X.

Adjust the voltage of channel 2 channel to 1mv/div, and make the waveform visible in the oscilloscope interface, press the **Measure** and measure the mean value of channel 2. Press the **Manual** and rotate the knob to adjust the waveform, so that the mean value of the observed CH2 will be in the range of  $\pm 1mv$ , and then press the Save, the oscilloscope display " Zero Adjust Success! ".

---

## Systems

### 1. System Status:

Press **Utility** → **NextPage4/4** → **AWG** → **System**, then select the System Status option to view the AWG's system information, including software version, hardware version, and serial number. After finished, press the return soft key to quit the interface of system information.

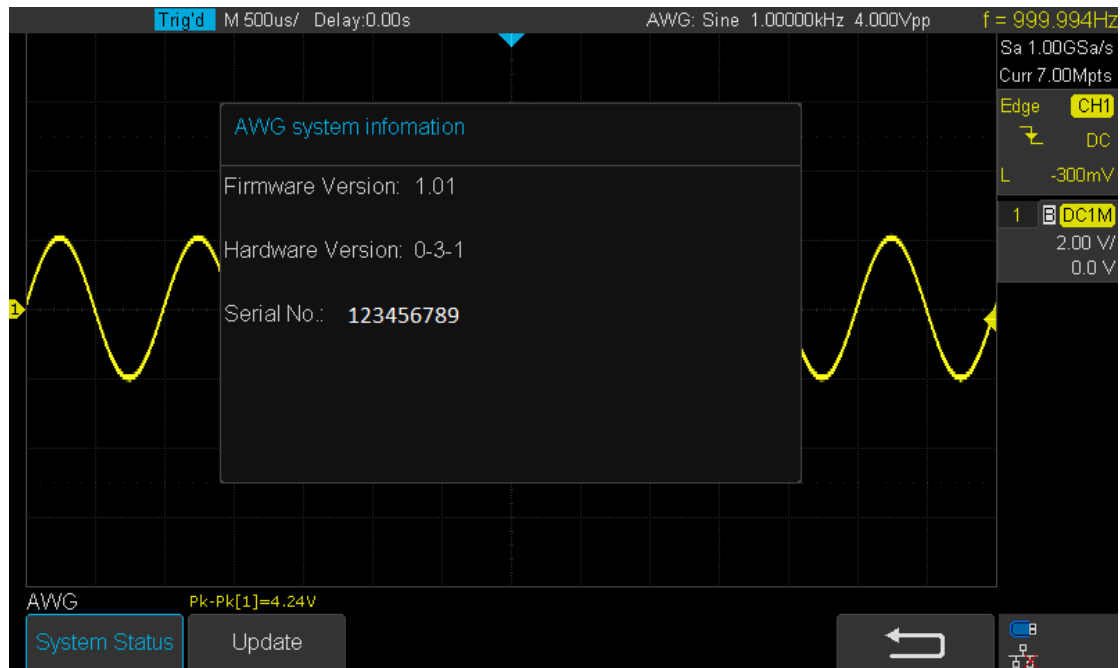

Figure 93 AWG System Information Interface

### 2. Update

The software version file of the AWG can be updated directly via U-disk. Follow the steps below:

1. Insert U-disk with firmware update file (\*.awg) to USB host interface on the front panel of the oscilloscope. A message "USB Flash Drive detected!" Will be displayed.
2. Press **Utility** → **NextPage4/4** → **AWG** → **System** → **Update**
3. Expand the U disk directory, Select the firmware file (\*.awg), then press the **Press** to update, an upgrade progress bar will be displayed on the interface.

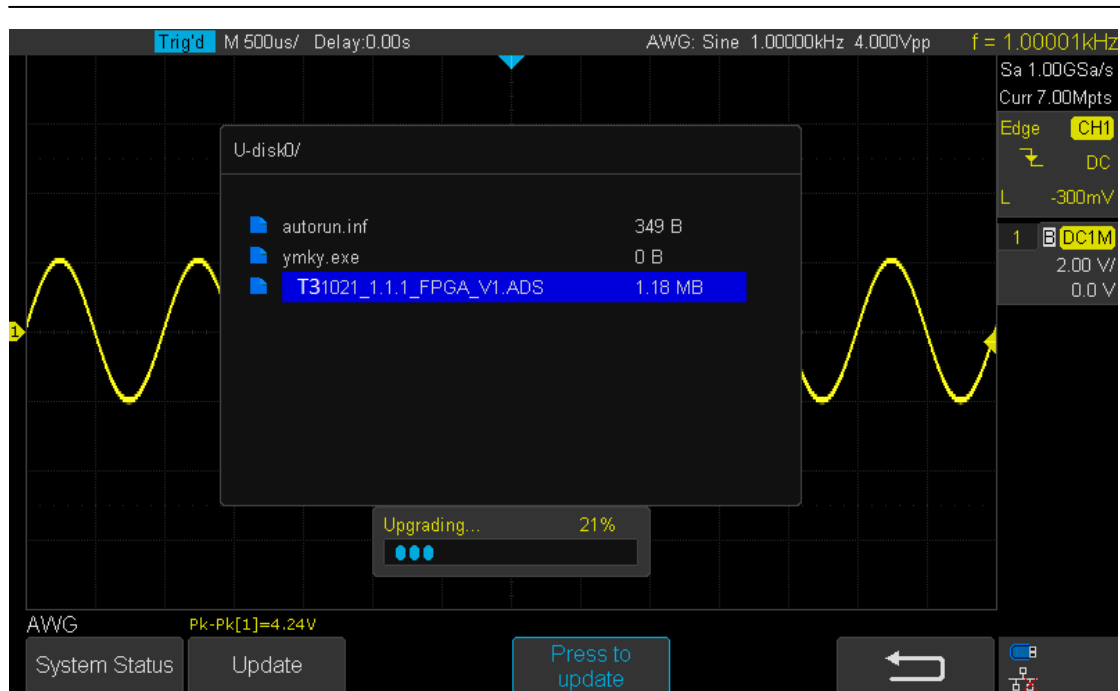

Figure 94 AWG Update Interface

1. After the update is finished, the AWG will automatically disconnect and display a message "Update completed, please reconnect AWG device!"

**Note:**

Don't disconnect the power whilst the AWG is being updated !

**Remove Device**

Press **Utility** → **NextPage4/4** → **AWG** → **RemoveDevice** and the oscilloscope interface will display "AWG device removed!" , the device can be unplugged.



---

## Setting IO Interfaces

The oscilloscope provides abundant IO interfaces, including: USB Device, LAN and Aux Output.

### To Set the USB Device

Do the following steps to set the oscilloscope to communicate with a PC via USB:

1. Install the USBTMC device driver on the PC. Also install NI Visa.
2. Connect the oscilloscope with the PC using a standard USB cable.
3. Press the **Utility** button on the front panel to enter the UTILITY function menu.
4. Press the **IO Set** softkey to enter the I/O SET function menu.
5. Press the **USB Device** softkey to select **USBTMC**.
6. Use NI Visa to communicate with the oscilloscope.

Do the following steps to set the oscilloscope to print the screen image:

1. Connect the oscilloscope with printer using a standard USB cable.
2. Press the **Utility** button on the front panel to enter the UTILITY function menu.
3. Press the **IO Set** softkey to enter the I/O SET function menu.
4. Press the **USB Device** softkey to select **Printer**.
5. Press the Print button on the front panel to print the screen image.

---

## To Set the LAN

Do the following steps to set the oscilloscope to communicate with PC via LAN:

1. Connect the oscilloscope to your local area network using the network cable.
2. Press the **Utility** button on the front panel to enter the UTILITY function menu.
3. Press the **IO Set** softkey to enter the I/O SET function menu.
4. Press the **Net Interface** softkey, then select LAN.
5. Press the **IP Set** softkey to enter the IP setting interface, see the picture below:

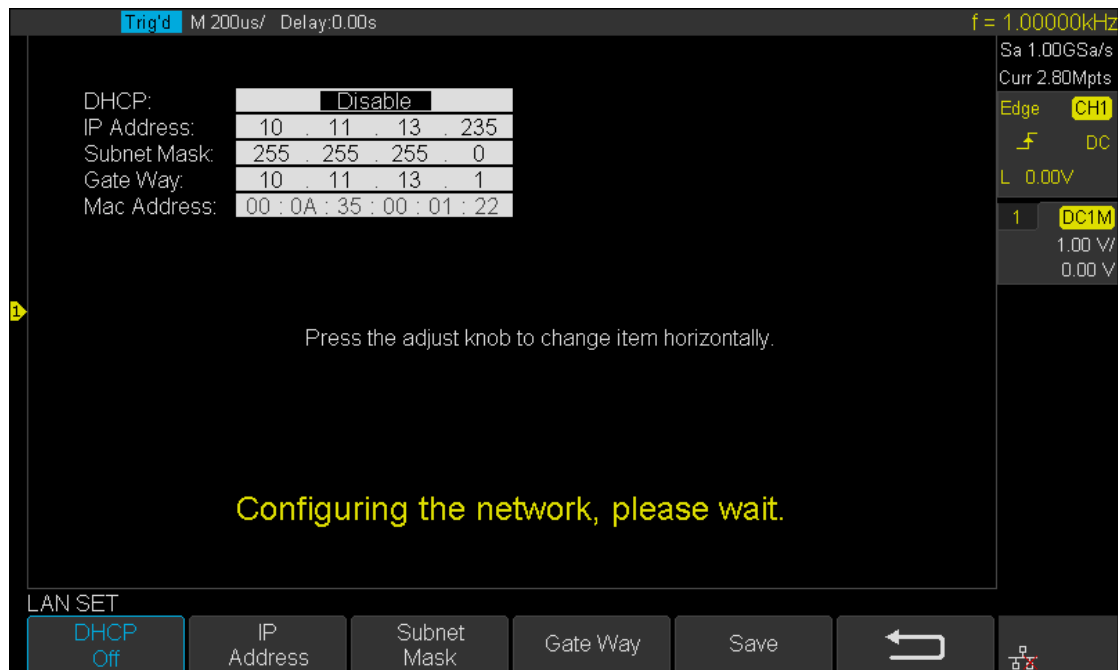

Figure 95 LAN Settings Interface

6. Press the DHCP softkey to turn on or turn off the DHCP.
  - **On:** the DHCP server in the current network will assign the network parameters (such as the IP address) for the oscilloscope.
  - **Off:** you can set the IP address, subnet mask, gateway manually.
    - Turn the **Universal Knob** to select the desired value.
    - Push the **Universal Knob** to move horizontally.
    - Press the Save softkey to save the current settings.
7. Use NI Visa to communicate with the oscilloscope.

---

## To Set the WLAN (Option)

Only 4 channel scopes support this function. Do the following steps to set the oscilloscope to communicate with a PC via WLAN:

1. Connect the oscilloscope USB Host to your wireless network adapter, and make sure your local wireless network is enabled.
2. Press the **Utility** button on the front panel to enter the UTILITY function menu.
3. Press the **IO Set** softkey to enter the I/O SET function menu.
4. Press the **Net Interface** softkey, then select WLAN.
5. Press the **WiFi Set** softkey to enter the WiFi set interface.

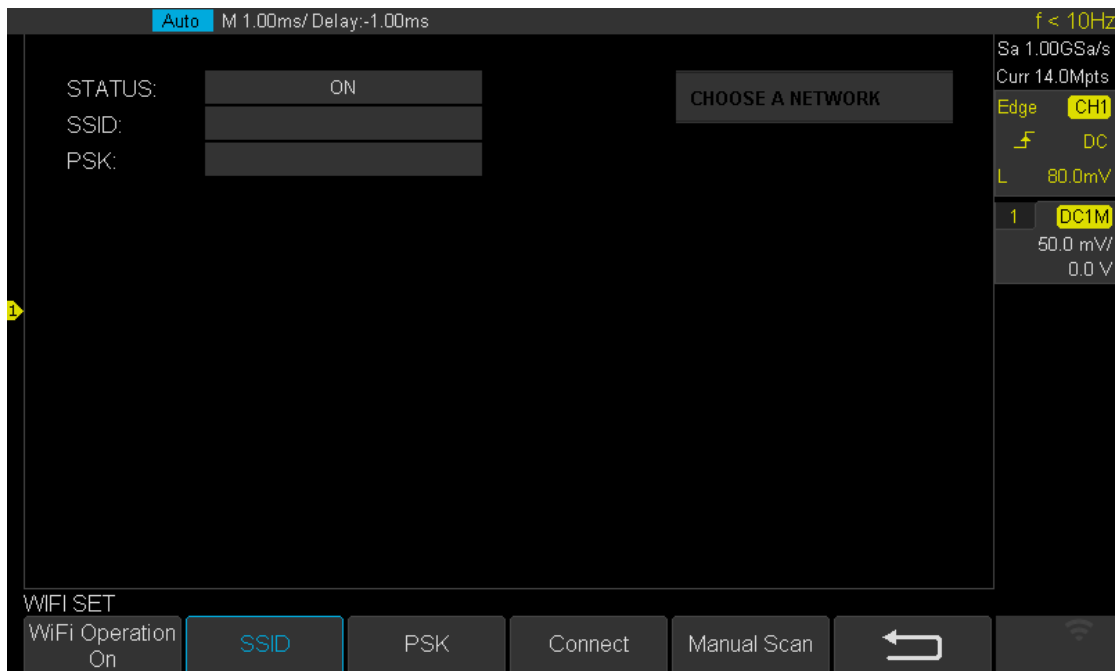

Figure 96 WIFI settings menu

6. Press the WiFi Operation softkey to turn on or turn off the WiFi setup menu.
  - Off:** the WiFi setup menu is off
  - On:** you can set the SSID and PSK manually.
    - Manual Scan: press this softkey, the oscilloscope will search the network automatically. Turn the **Universal Knob** to select a network; then press the **Universal Knob** to confirm.
    - SSID: press this softkey, a dialogue box will pop up, enter your SSID then press **Confirm**.
    - PSK: press this softkey, a dialogue box will pop up, enter your SSID then press **Confirm**.
    - Connect: press this softkey to connect to the wireless network.
7. Press Connect softkey when your SSID and PSK configuration are finished.
8. Return to the I/O SET menu. Press the **IP Set** softkey to finish the IP configuration (see "To Set the LAN")
9. Use NI Visa to communicate with the oscilloscope.

---

## To Set Aux Output

The default Aux output type is **Trig Out**. If **Pass/Fail** is enabled, it will change to **Pass/Fail** automatically.

- **Trig Out:** The oscilloscope outputs a signal on each oscilloscope trigger. The maximal capture rate is 100k wfs/s.
- **Pass/Fail:** The oscilloscope will output a pulse signal when failed waveforms are detected. This signal can be connected to other control systems to conveniently trigger other test equipment or processes.

---

## To Use the Web Server

T3DSO1000 (4-channel scopes) provides the web server function; you can access and control the oscilloscope using a web browser. Connect the oscilloscope to your LAN (or WLAN), then type the oscilloscope's IP address in the web browser. The oscilloscope's web interface is displayed. The default user name is "admin", and there is no password.

1. Press the **Utility** button on the front panel to enter the UTILITY function menu.
2. Press the **WebServer** softkey on the fourth page of utility function menu to enter the WEBSERVER menu.

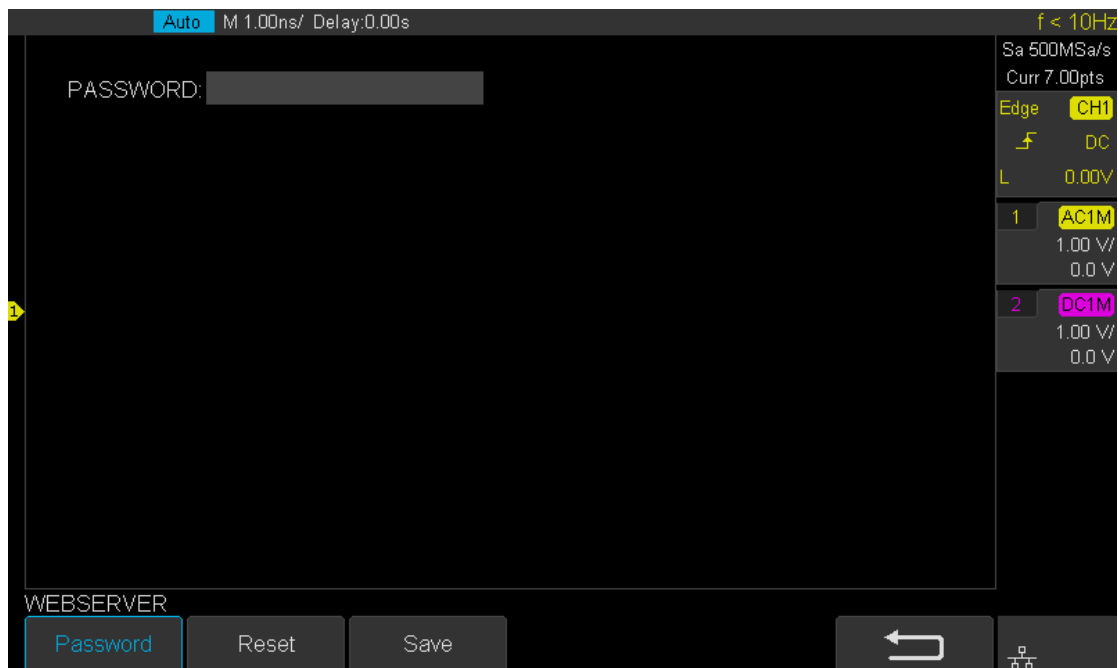

Figure 97 web server interface

- **Password:** press this softkey to set a new password.
- **Reset:** press this softkey to erase the password.
- **Save:** Select Save to make the new password or erasing the password effective.

---

## To Update Firmware and Configuration

The firmware and configuration can be updated directly via USB flash drive.

Do the following steps to update the firmware:

1. Insert the USB flash drive which contains the firmware and the configure files into the USB host interface on the front panel of the oscilloscope.
2. Press the **Utility** button on the front panel to enter the UTILITY function menu.
3. Press the **Next Page** softkey to go to the second page of the UTILITY function menu.
4. Press the **Next Page** softkey to go to the third page of the UTILITY function menu.
5. Press the **Update** softkey to enter the UPDATE function menu.
6. Press the **Firmware** softkey and the message **“Press “Single” to continue and Press “Run/Stop” to exit!**
7. Press the **Single** button to enter the SAVE/RECALL file system.
8. Turn the **Universal Knob** to select the update file which should be with an ADS postfix, and then press the **Load** softkey to start the firmware update. The process needs about 7 minutes. And during the update, do not turn off the oscilloscope or disconnect the oscilloscope power, otherwise the oscilloscope will not start again.
9. After the update has finished, the screen will display the message **“Update success, please restart the DSO”**, and the oscilloscope buzzer will sound.
10. Restart the oscilloscope to finish the firmware update.

Do the following steps to update the configuration:

1. Insert the USB flash drive which contains the firmware and the configure files into the USB host interface on the front panel of the oscilloscope.
2. Press the **Utility** button on the front panel to enter the UTILITY function menu.
3. Press the **Next Page** softkey to go to the second page of the UTILITY function menu.
4. Press the **Next Page** softkey to go to the third page of the UTILITY function menu.
5. Press the **Update** softkey to enter the UPDATE function menu.
6. Press the **Configure** softkey to enter the SAVE/RECALL file system.
7. Turn the **Universal Knob** to select the update file which will have a CFG postfix, and then press the **Load** softkey to start updating the firmware. The process needs about 30 seconds.
8. After the update has finished, the screen will display the message **“Update success, Please restart the DSO”**, and the oscilloscope buzzer will sound.
9. Restart the oscilloscope to finish the configuration update.

---

## Self Test

Self test includes screen test, keyboard test, buttons, knobs and LED test.

### Screen Test

1. Press the **Utility** button on the front panel to enter the UTILITY function menu.
2. Press the **Next Page** softkey to go to the second page of the UTILITY function menu.
3. Press the **Next Page** softkey to go to the third page of the UTILITY function menu.
4. Press the **Do Self Test** softkey to enter the SELFTEST function menu.
5. Press the **Screen Test** softkey to enter the screen test interface. The picture below shows the screen displaying pure red.

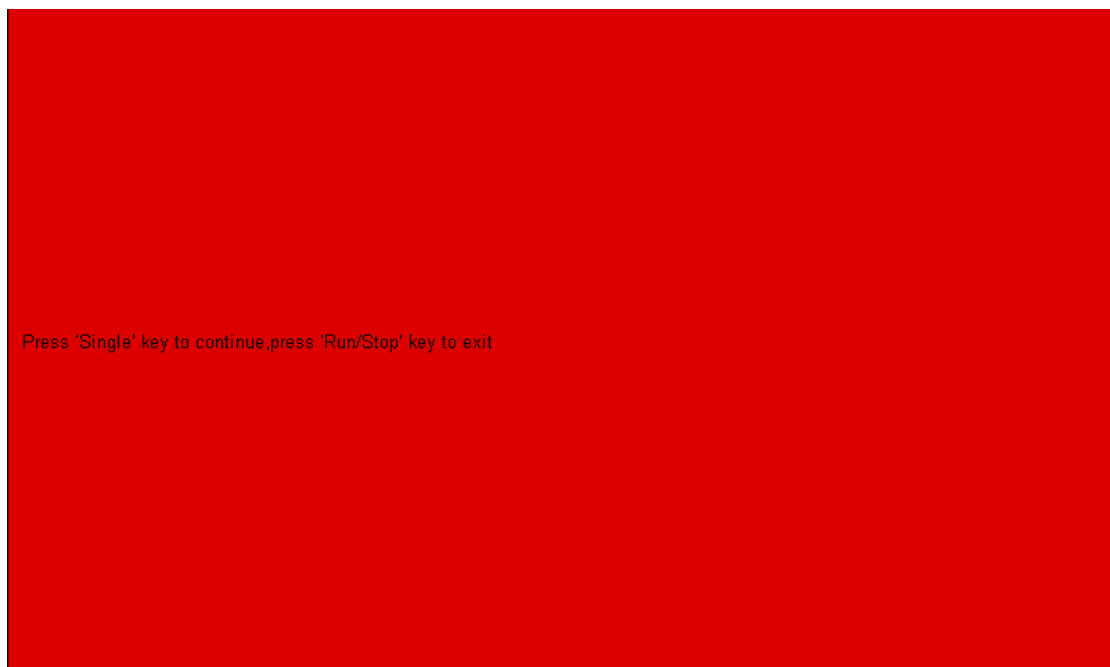

Figure 98 Screen Test

6. Press the **Single** button on the front panel to continue as in the picture above. The screen displays green, blue and red again. It is easy to check chromatic aberrations, stains and scratches of the screen under these conditions.
7. Press the **Run/Stop** button on the front panel to exit the screen test program.

---

## Keyboard Test

Keyboard test is used to test that the keys and knobs work correctly.

Do the following steps to do the keyboard test:

1. Press the **Utility** button on the front panel to enter the UTILITY function menu.
2. Press the **Next Page** softkey to go to the second page of the UTILITY function menu.
3. Press the **Next Page** softkey to go to the third page of the UTILITY function menu.
4. Press the **Do Self Test** softkey to enter the SELFTEST function menu.
5. Press the **Keyboard Test** softkey to enter the keyboard test interface, as the picture shows below.

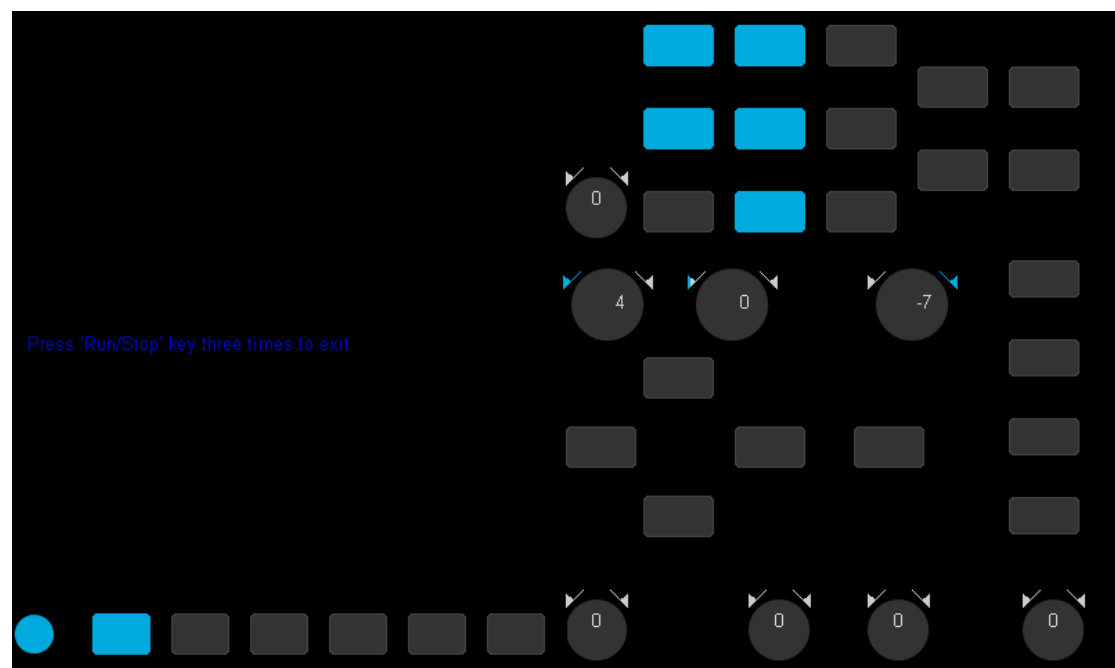

Figure 99 Keyboard Test

6. How to perform the knobs and the buttons test.

Knob test: The default value is 0. Turn the knob left to increase the value whilst turning the knob right will decrease the value. Push the knob to set the value to 0.

Button test: A button will light up the first time a button is pressed, and extinguished the second time the button is pressed.

7. Press the **Run/Stop** button 3 times to exit the keyboard test program.



---

## LED Test

LED test is used to test the button lights.

1. Press the **Utility** button on the front panel to enter the UTILITY function menu.
2. Press the **Next Page** softkey to go to the second page of the UTILITY function menu.
3. Press the **Next Page** softkey to go to the third page of the UTILITY function menu.
4. Press the **Do Self Test** softkey to enter the SELFTEST function menu.
5. Press the **LED Test** softkey to enter the keyboard test interface, as the picture shown below.

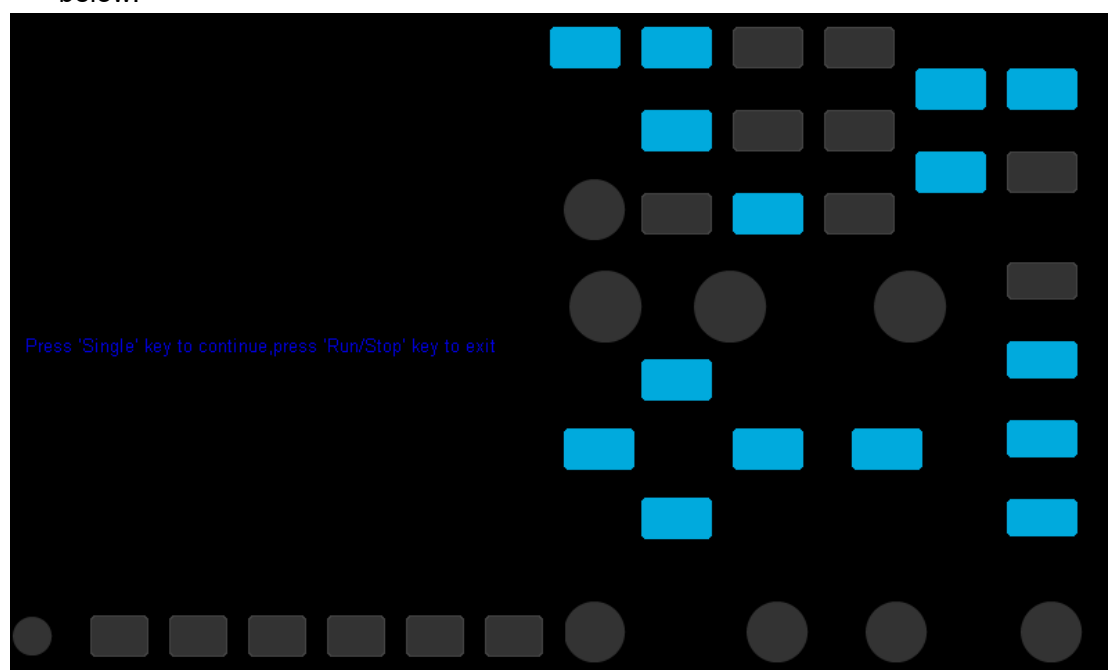

Figure 100 LED Test

6. Use the information displayed on the screen to test the LEDs: press the **Single** button continually to light the button lights one at a time. The **Run/Stop** button displays red the first time the **Single** Button is pressed. On the second press the **Run/Stop** button displays green. Then the other button lights will be lit one by one. On the last press all of the buttons will be lit at the same time.
7. Press the **Run/Stop** button to exit the LED test program.

---

## Specify Screen Saver Time

When the oscilloscope enters the idle state for a certain period of time, the screen saver program will be enabled.

Do the following steps to set the screen saver time:

1. Press the **Utility** button on the front panel to enter the UTILITY function menu.
2. Press the **Next Page** softkey to go to the second page of the UTILITY function menu.
3. Press the **Next Page** softkey to go to the third page of the UTILITY function menu.
4. Press the **Screen Saver** softkey; and then turn the **Universal Knob** to select the desired screen saver time. The screen saver time can be set to **1min**, **5min**, **10min**, **30min**, and **1hour**. Also you can select **Off** to turn off the screen saver function.

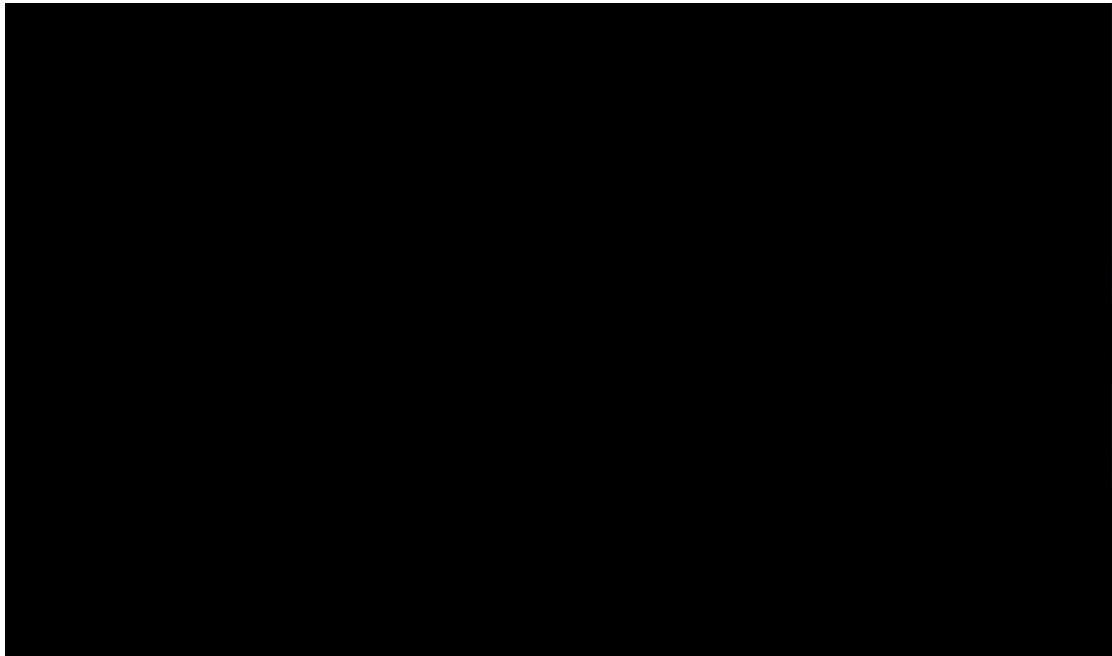

Figure 101 Screen Saver Interface

5. Press the any button on the front to exit the screen saver program.

---

## To Use the Expand Setting

Press the **Utility** button on the front panel; then; press **Expand Setting** softkey to enter the EXPANDESETTING menu.

Press the **Vertical** softkey to select **Fixed Offset** or **Fixed Position**.

**Fixed Position:** when the vertical gain is changed, the oscilloscope will keep the vertical

offset level indicator stationary.

**Fixed offset:** when the vertical gain is changed, the oscilloscope will vertical offset level indicator will move with the actual voltage level.

Press the **Horizontal** softkey to select **Fixed Delay** or **Fixed Position**.

**Fixed Position:** when the timebase is changed, the oscilloscope will keep the horizontal

offset indicator stationary.

**Fixed offset:** when the timebase is changed, the oscilloscope horizontal offset indicator move with the trigger point.

## To Use the Power On Line

Press the **Utility** button on the front panel, then press **Power On Line** softkey to select **Enable** or **Disable**.

**Enable:** The oscilloscope will turn on automatically when it is plugged in to a live wall socket / power outlet.

**Disable:** The oscilloscope will NOT turn on automatically when it is plugged in to a live wall socket / power outlet. The power key at the lower-left corner of the front panel of the oscilloscope will need to be pressed to start the oscilloscope.

---

## Option Management

The T3DSO1000 provides multiple options to fulfil your measurement requirements. Please contact your **Teledyne Test Tools** sales representative or **Teledyne Test Tools** technical support to order the corresponding options. You can view the options currently installed on the oscilloscope or activate the newly purchased option license codes through this menu.

Do the following steps to install the option on the oscilloscope:

1. Press the **Utility** button on the front panel to enter the UTILITY function menu.
2. Press the **Next Page** softkey to go to the third page of the UTILITY function menu.
3. Press the **Options** softkey to enter the OPTION function menu.



Figure 102 OPTION Function Menu

4. Press the **Type** softkey; then turn the **Universal Knob** to select the module to be installed and push down the knob to confirm.
5. Press the **Install** softkey to enter the LABEL function menu to input the license.

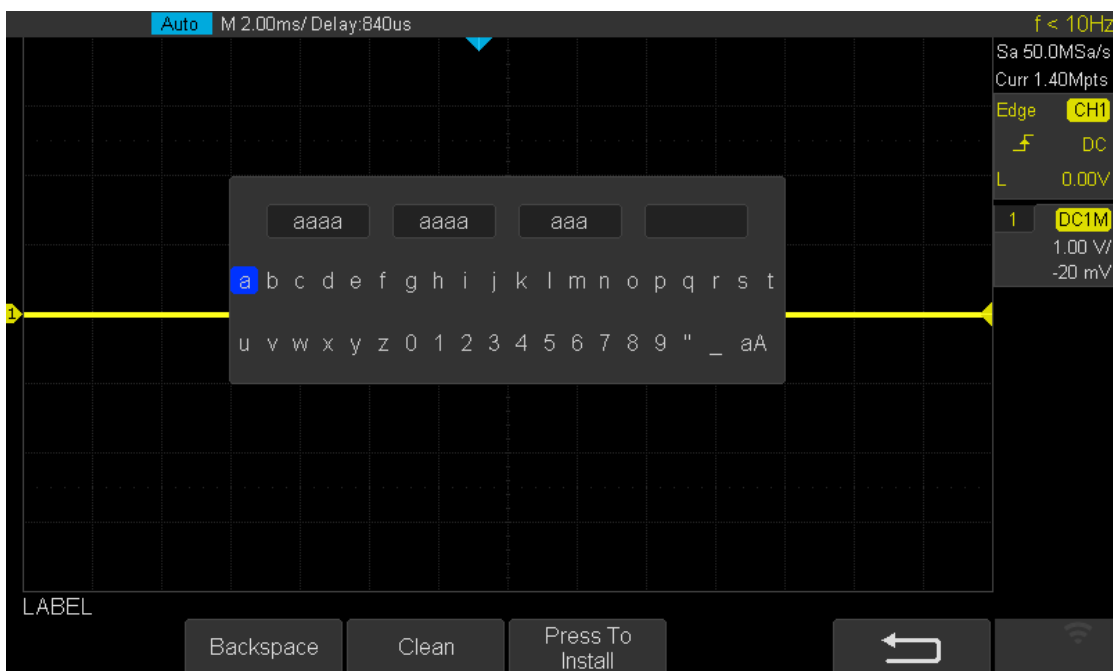

Figure 103 LABEL Function Menu

- Turn the **Universal Knob** to select character
  - Push the **Universal Knob** to confirm the characters
  - Press the **Press To Install** when license key input is complete.
  - Press the **Clean** softkey or the **Backspace** softkey to delete an incorrect character.
6. Press the **Information** softkey to view the option information.

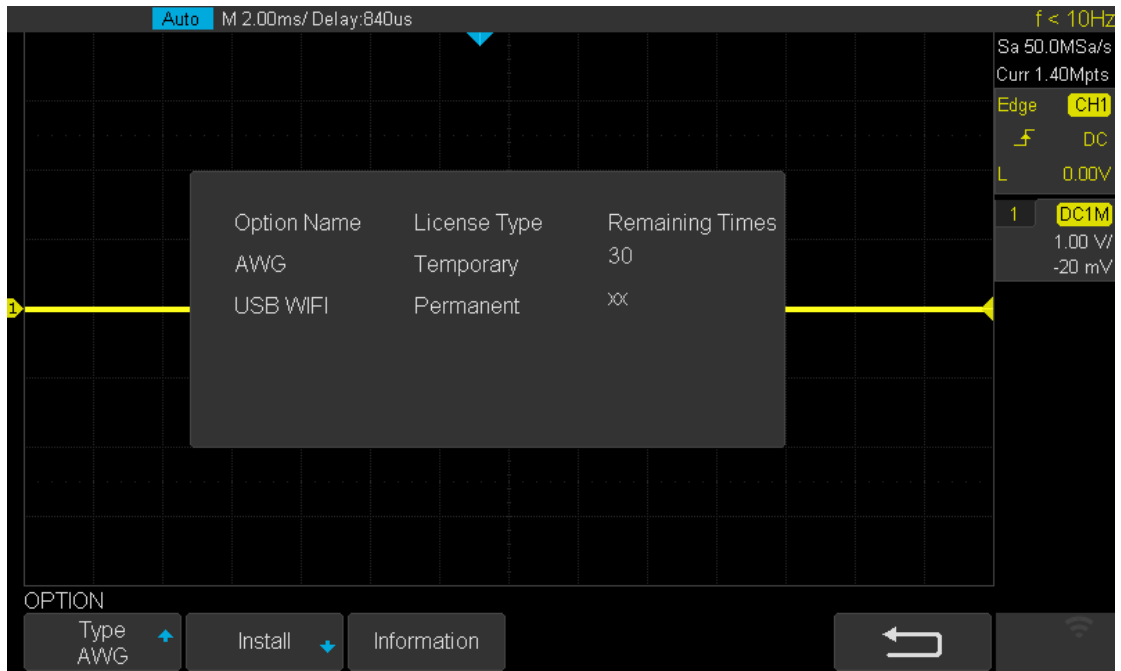

Figure 100 Option Information

---

## Search

The T3DSO1000 4 channel scopes provides a search function. This function can search for the events that users specify in the acquired data. The results are displayed with a white triangle symbol. The maximum search events is 700 in the YT mode or the Roll mode with the acquisition in stopped. In the Roll mode, with acquisition in running, the maximum search events number is unlimited. The waveform can be zoomed when the search function is enabled.

The T3DSO1000 2 channel oscilloscopes do not have the search function.

## Setting

1. Press the **Search** button on the front panel to enter the SEARCH function menu
2. Press the **Mode** softkey and then use the **Universal Knob** to select the desired search type. The T3DSO1000 oscilloscope provides five search types: Edge, Slope, Pulse, Interval, Runt.



Figure 105 Search menu

3. Press the Setting softkey to enter the SETTING function menu. The setting menu is different according to every search type. The details are shown in the following table.

---

Search Mode	Setting Menu Description
Edge	Slope includes Rising, Falling, Either.
Slope	Slope includes Rising, Falling Limit Range includes four types: <=, >=, [--,--] and --[-- , Users can select the desired type and then input the time value.
Pulse	Polarity includes Positive and Negative Limit Range includes four types: <=, >=, [--,--] and --[-- , Users can select the desired type and then input the time value.
Interval	Slope includes Rising, Falling Limit Range includes four types: <=, >=, [--,--] and --[-- , Users can select the desired type and then input the time value.
Runt	Polarity includes Positive and Negative Limit Range includes four types: <=, >=, [--,--] and --[-- , Users can select the desired type and then input the time value

4. Press Copy softkey to enter the COPY function menu.
  - Copy from Trig: copy the trigger setup for the selected search type to the search setup.
  - Copy to Trig: copy the setup for the selected search type to set the trigger type.
  - Cancel Copy: undo a copy.
5. Press Thresholds softkey to enter THRESHOLDS function menu, then set the channel search thresholds.

## Results

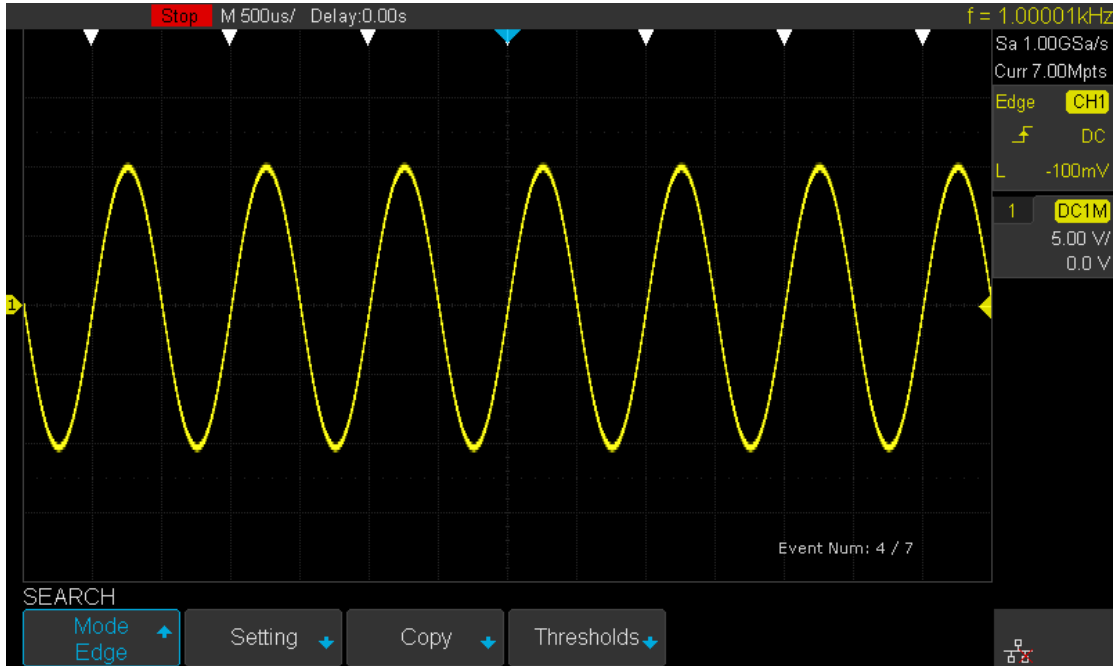

Figure 106 Search When Stopped

For example, when the acquisition is stopped, “EVENT NUM:4/7” means the current event number and total number of events. The current event (number 4) is the closest event to the middle of the screen.

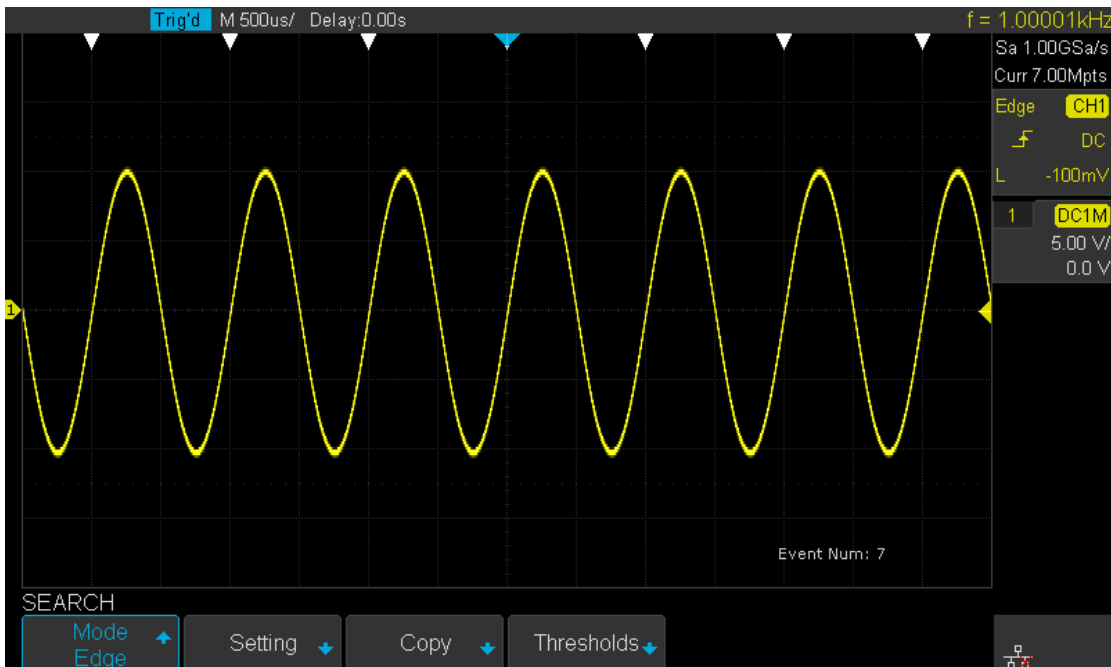

Figure 107 Search When Running.

When the acquisition is running, “EVENT NUM:7” means the total number of events.



---

# Navigate

The T3DSO1000 4 channel oscilloscope models provide three navigation types: Search Event, Time, History Frame.

This is not available on the 2 channel models.

## Time navigate

1. Press **Navigate** on the front panel to enter the NAVIGATE function menu.
2. Press **Type** softkey In the NAVIGATE function menu, then, select **Time**.
3. There are two ways to navigate time.
  - a) Press **Time** softkey, then turn the Universal Knob to select the desired value or press the Universal Knob then enter the value in the pop up keyboard.
  - b) Press the navigation keys ◀■▶ on the front panel to play backward, stop, or play forward in time. You can press the ◀ or ▶ keys multiple times to speed up the playback. There are three speed levels: Low Speed, Medium Speed, High Speed.

## History frame navigate

When the History function is enabled, you can use the navigation controls to play through the acquired frames.

1. Press **Navigate** on the front panel to enter the NAVIGATE function menu.
2. press **Type** In the Navigate Menu, then select **History Frame**.
3. Press **Frame Num** softkey. There are two ways to navigate history frames.
  - a) Turn the Universal Knob to select the desired number or press the Universal Knob then enter the number using the pop up keyboard.
  - b) Press the navigation keys ◀■▶ on the front panel to play backward, stop, or play forward.

---

## Search event navigate

When the Search function is enabled and acquisitions are stopped, you can use the navigation controls to go to the search events.

1. Press **Navigate** on the front panel to enter the NAVIGATE function menu.
2. Press **Type** In the NAVIGATE function menu; then, select **Search Event**.
3. There are two ways to navigate search events.
  - a) Press **Event Num** softkey, then, turn the Universal Knob to select the desired value or press the Universal Knob then enter the value from the pop up keyboard.
  - b) Press the navigation keys ◀ ▶ on the front panel to go to the previous or next search event.

## Bode Plot

The bode plot application for the T3DSO1000 (4 channel scope models only) controls a external arbitrary waveform generator (AWG, only the Teledyne Test Tools T3DSO1000 arbitrary waveform generator is supported) to sweep a sine wave across a range of frequencies while measuring the input to and output from a device under test (DUT). At each frequency, gain and phase are measured and plotted on a Bode chart.

Bode Plot is not supported on the two channel T3DSO1000 oscilloscopes.

---

## Perform a Bode Plot

This section gives an overview of the steps to take when performing a Bode Plot measurement.

1. Press the **Utility** on the front panel to enter the UTILITY function menu; then press the **Next Page** softkey to enter the second page.
2. Press **Bode Plot** softkey to enter the BODEPLOT function menu, only the **Default** button on the front panel can be used.

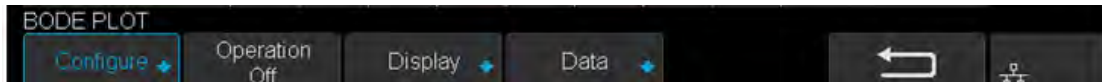

Figure 108 Bode plot menu

3. Configure the parameters (the details see the “**setting**” section).
4. Press **Operate** softkey to perform the test.

## Setting

1. Press **Configure** softkey to enter the Configure menu. All the parameters in this menu are used to configure the external AWG.

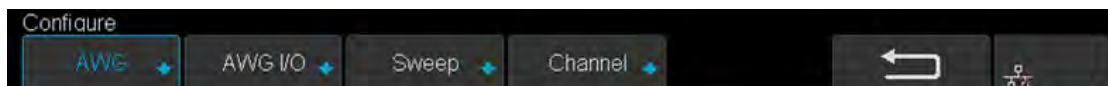

Figure 109 Bode plot configure menu

- (1) Press **AWG** softkey to enter AWG menu.
  - Press the **Amplitude** softkey (**Offset** softkey), then turn the Universal Knob to select the desired value, or press the Universal Knob then enter the value using the pop up keyboard.
  - Press the **Unit** softkey, then turn the Universal Knob to select the desired units. There are six types: Vpp, Vrms, dBV, dBu, dBm, Arbitrary dB. The dBu is only available when the load impedance is specified as 600 ohms.
  - Press the **Load** softkey, then turn the Universal Knob to select the desired value, or press the Universal Knob then enter the value using the pop up keyboard.

- (2) Press **AWG I/O** softkey to enter the AWG I/O menu.
- Press the **Type** softkey, then turn the Universal Knob to select the desired type.

USB	Connect the oscilloscope USB Host to the external AWG's USB Device via a USB cable.
LAN	Connect the oscilloscope and the external AWG to your local area network.

- If the LAN is selected, press the **IP** softkey. A dialog box named "IP" will pop up. Turn the universal knob to enter the IP value. The IP is the external AWG's IP.
  - Press **Test Connection** softkey to check the connection.
- (3) Press the **Sweep** softkey to enter the Sweep menu.
- Linear mode, this mode gives center frequency and span frequency adjustments.
  - Logarithmic mode, this mode gives start frequency and stop frequency adjustments.
  - Press **Resolution** softkey, then turn the universal knob to select the type. There are three resolution levels: Low, Medium, and High.
- (4) Press **Channel** softkey to enter the Channel menu. Press **DUT Input** softkey to choose the oscilloscope's channel which connects to the DUT input (the AWG's output). Press **DUT Output1** softkey to choose the oscilloscope's channel which connects to the DUT output (up to 3 channels).
2. Press **Display** softkey to enter the Display menu. All the parameters in this menu are used to configure the bode chart.

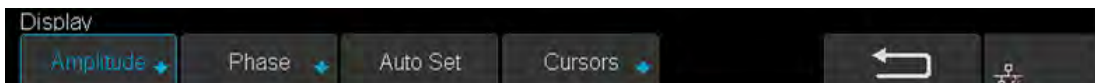

Figure 110 Bode plot display menu

- (1) Press **Amplitude** softkey to enter the Amplitude menu.
- Press **Scale** softkey, then turn the Universal Knob to select the desired value.
  - Press **Ref Level** softkey, then turn the Universal Knob to select the desired value or press the Universal Knob then enter the value using the pop up keyboard.
  - Press **Auto Set** softkey to automatically set the appropriate parameters for the frequency response gain curve.
  - Press **Mode** softkey to set the mode of the frequency response gain curve. Vout/Vin means that the measured gain value of each frequency point is the ratio of DUT input signal amplitude to DUT output signal amplitude. Vout means that the measured gain values of each frequency point is the DUT output signal amplitude.

When Vout/Vin mode is enabled, the Y-Axis can be set to linear or logarithmic by pressing **Axis Type** softkey. When Vout mode is enabled, there are six types unit can be chosen by pressing **Unit** softkey.

- (2) Press **Phase** softkey to enter the Phase menu.
    - Press **Scale** softkey, then turn the Universal Knob to select the desired value.
    - Press **Ref Level** softkey, then turn the Universal Knob to select the desired value or press the Universal Knob then enter the value by the pop keyboard.
    - Press **Unit** softkey to set the unit to deg or rad.
    - Press **Auto Set** softkey to set the appropriate parameters for the frequency response phase curve automatically.
  - (3) Press **Cursors** softkey enter the Cursors menu. Press **Status** softkey in this menu can enable or disable the cursors function. The details of cursors see Chapter “Cursors”.
3. Press **Data** softkey to enter the Data menu. All the parameters in this menu are used to configure the bode chart.

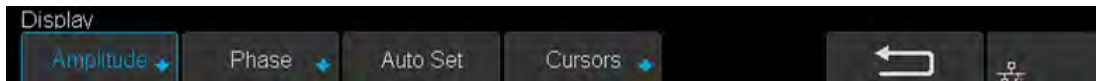

Figure 111 Bode plot data menu

- (1) Press **List** softkey to select “On” or “Off” to turn on or turn off the list table. When the list is on, press Scroll softkey, then turn the Universal Knob to select the frequency point or press the Universal Knob then enter the number of the frequency point by the pop keyboard.

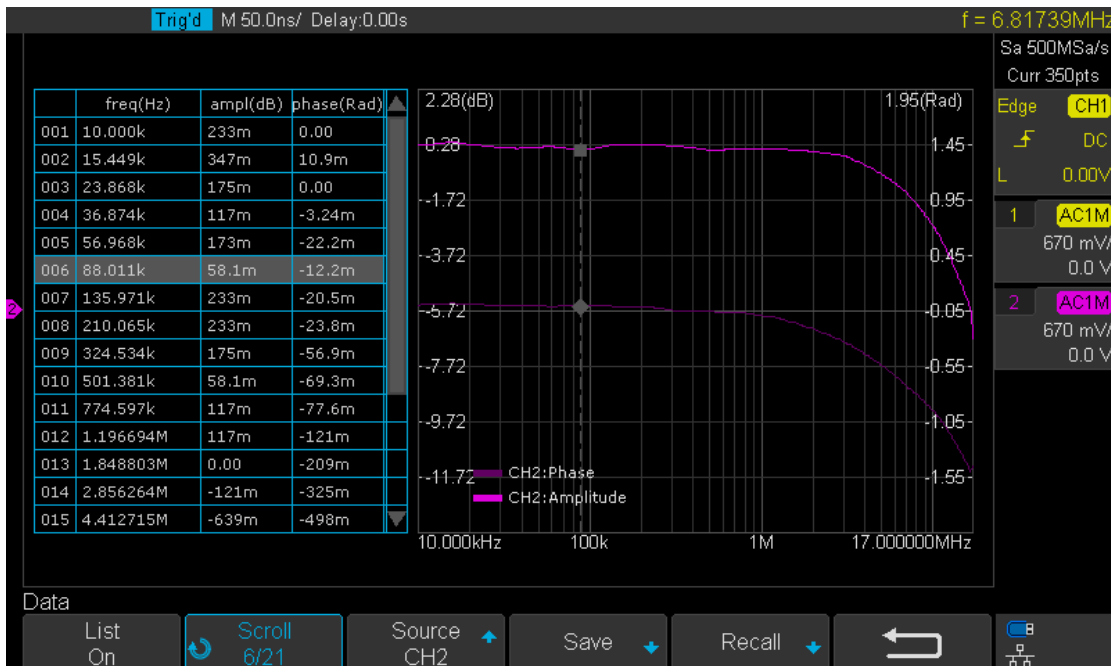

Figure 112 Bode plot list on

- (2) Press **Source** softkey to choose the output DUT channel that you require.
- (3) Press **Save** softkey (**Recall** softkey) to enable the bode plot save (recall) function. For the details of save (recall) see Chapter “Save and Recall”.

## The History Function

The history function will continuously record the waveforms of the input channels. The oscilloscope records input waveform continually when running. When the history memory is full (reach the maximal frame) the new acquisitions will replace the old acquisitions and keep the latest acquisitions (FIFO).

To use the History function, the HORIZONTAL **Format** must be set to **YT**.

Do the following steps to record and replay a waveform:

1. Press the **History** button on the front panel to enable the History function.
  - If the oscilloscope is running, it will then stop.
  - If the oscilloscope is stopped it will remain in the stopped state.
  - Press the **History** or **Stop** button to turn off the History function.
2. Press the **List** softkey to turn on or off the list display. The list records the timestamp of every frame. It is accurate to microseconds.

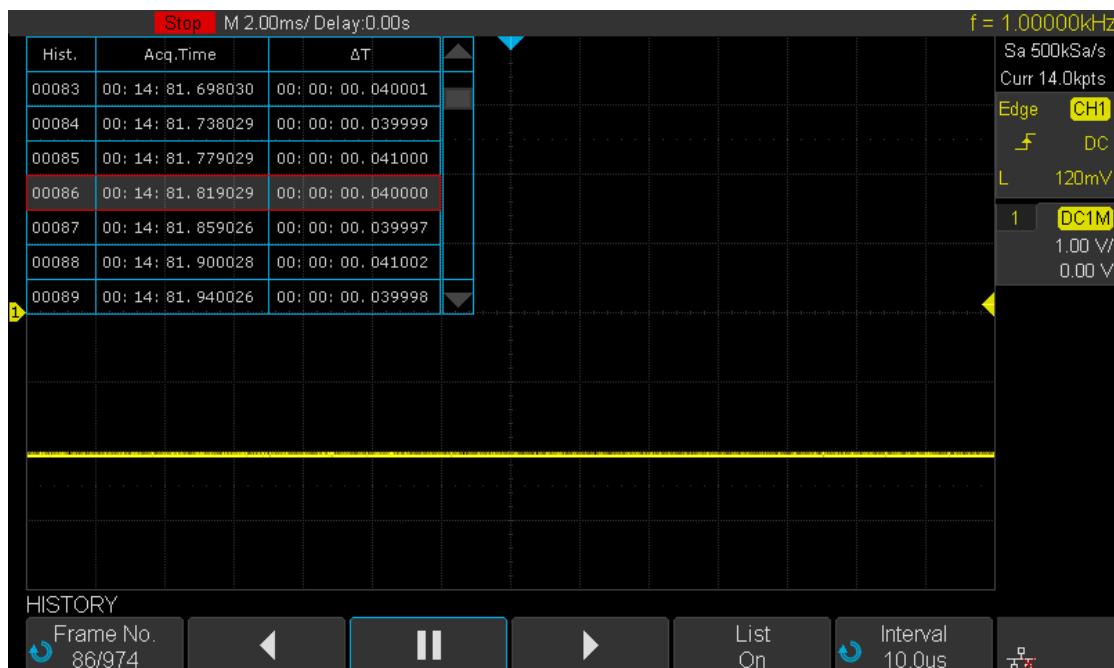





Figure 113 History

3. Press the **Frame** softkey; then turn the **Universal Knob** to select the acquisition to display.
  - The format of the **Frame** is A/B; A is the acquisition number that is displaying on the screen and B is the maximal acquisition number that can be set.

- The maximal acquisition number is determined by the current sampling point (**Curr** value) and sampling rate.
- The History Mode maximum acquisition count can only be reached if enough acquisitions have been acquired, otherwise a smaller number of acquisitions will be shown.

The table below shows the maximal number of acquisition frames according to the sampling rate and current number of sampling points.

Sample Rate	Curr (pts)	Max. Frame	Sample Rate	Curr (pts)	Max. Frame
1GSa/s	≅280	80000	500MSa/s	35K	783
	700	57227		70K	391
	1.4K	33528		140K	195
	2.8K	18338		350K	77
	7K	7773		700K	38
	14K	3982		1.4M	18
	28K	1993		3.5M	6
	70K	798		7M	3
	140K	398		14M	1
	280K	198		3.5K	3779
	700K	78		7K	1891
	1.4M	38		14K	945
	2.8M	18		17.5K	757
	7M	7		35K	378
14M	3	70K	188		
500MSa/s	≅35	80000	≅250MSa/s	140K	93
	70	77026		175K	74
	140	65667		700K	17
	350	45526		1.4M	8
	700	29140		1.8M	6
	1.4K	16945		3.5M	3
	3.5K	7510		7M	1
	7K	3912		14M	1
	14K	1958			

4. Press the  softkey to replay the waveform from the current frame to 1.
5. Press the  softkey to stop replay.
6. Press the  softkey to replay the waveform from the current frame to the last frame.

---



## Factory Setup

Press Save/Recall function key, then press “Save” menu. Select “To Default Key”, set the type to “Factory Setup”. Then press the Default button on the front to set the oscilloscope to the factory setup. Another way is to press Save/Recall function key, then press “Recall” menu. Select “Factory Default” to recall.

The Factory Default details are shown below.

<b>Horizontal</b>	
T/div	1 $\mu$ S/div
Delay	0 S
Zoom	Off
Format	Y-T
<b>Vertical</b>	
Channel on/off	CH1
V/div	1 V/div
Offset	0 V
Coupling	DC
BW Limit	Full
Adjust	Coarse
Probe	1X
Impedance	1 M $\Omega$
Unit	V
Invert	Off
<b>Acquire</b>	
Acquisition	Normal
Sinx/x	Sinx
Mem Depth	14 Mpts
<b>Trigger</b>	
Type	Edge
Source	CH1
Slope	Rising
Holdoff	Off
Coupling	DC
Noise Rejest	Off



Mode	Auto
<b>Display</b>	
Type	Vectors
Color	Off
Persist	Off
Grid	
Intensity	50%
Graticule	20%
Transparence	80%
<b>Cursor</b>	
Mode	Off
Type	X1
Source	CH1
X1	-3.5µs
X2	3.5µs
<b>Save/Recall</b>	
Type	Setups
Save To	Internal
Setup	NO.1
<b>Utility</b>	
<b>IO Set</b>	
USB Device	USBTMC
Aux Output	Trig Out
<b>Sound</b>	
Sound	On
<b>Pass/Fail</b>	
Enable Test	Off
Source	CH1
Operate	Off
Mes Display	Off
X Mask	0.2
Y Mask	0.2
Location	Internal
Fail To Stop	Off
Output	
<b>System Setup</b>	

Quick-Cal	Off
Screen Saver	30min
<b>Math</b>	
Operate	Off
<b>+</b>	
Source A	CH1
Source B	CH1
Invert	Off
V/div	1.00 V/div
offset	0V
<b>-</b>	
Source A	CH1
Source B	CH1
Invert	Off
V/div	1.00 V/div
offset	0 V
<b>*</b>	
Source A	CH1
Source B	CH1
Invert	Off
V/div	1.00 V <sup>2</sup> /div
offset	0 V <sup>2</sup>
<b>/</b>	
Source A	CH1
Source B	CH1
Invert	Off
V/div	1.0/div
offset	0
<b>FFT</b>	
Source	CH1
Window	Hanning
Horizontal	1X
Vertical Scale	20 dBVrms
Display	Split
Horizontal Scale	100MHz
<b>d/dt</b>	
Source	CH1
Vertical Scale	1.00 (MV/S)/div

Vertical Offset	0
dx	0.2 div
<b>∫dt</b>	
Source	CH1
Offset	0
Vertical Scale	1.00 $\mu$ V/div
Vertical Offset	0
<b>√</b>	
Source	CH1
Vertical Scale	1.00 $V^{1/2}$ /div
Vertical Offset	0
<b>REF</b>	
Source	CH1
Location	REF A
Display	Off

---

# Troubleshooting

The commonly encountered failures and their solutions are listed below. Please contact **Teledyne Test Tools** if the problem is not listed below and you need further assistance.

1. **The screen has no display after power on:**

- 1) Check whether the power is correctly connected.
- 2) Check whether the power switch is really on.
- 3) Check whether the fuse has blown. If the fuse needs to be changed, please use the specified fuse.
- 4) Restart the instrument after finishing the above checks.
- 5) If it still does not work correctly, please contact **Teledyne Test Tools**.

2. **The signal is sampled but no waveform is displayed:**

- 1) Check whether the probe is correctly connected to the DUT waveform.
- 2) Check whether the probe or BNC cable is correctly connected to the oscilloscope BNC.
- 3) Check whether the oscilloscope channel is turned on.
- 4) Check whether there are signals generated from the item to be tested (you can connect the probe compensation signal to the oscilloscope channel to ensure that the scope channel and probe are working correctly).
- 5) Resample the signal, press Run.

3. **The tested voltage amplitude is greater or lower than the actual value (note that this problem usually occurs when a probe is used):**

Check whether the attenuation coefficient of the channel complies with the attenuation ratio of the probe.

4. **There is an unstable waveform display:**

- 1) Check that the trigger signal source has a suitable signal to trigger on.
- 2) Check the trigger type: general signals should use the "Edge" trigger.
- 3) Change the trigger holdoff setting if the signal is a burst type waveform.

5. **No display after pressing Run/Stop:**

Check whether the trigger mode (TRIGGER) is on "Normal" or "Single" and whether the trigger level exceeds the waveform voltage range. Try setting the trigger level to the middle of the expected waveform voltage range, or set the mode to "Auto".

Note: using **AUTO** will automatically trigger the scope whether there is a waveform present or not.

---

6. **The display of waveform is ladder-like:**

- 1) The horizontal time base might be too low. Increase the horizontal time base to increase the horizontal resolution and improve the display.
- 2) If the display **Type** is “Vectors”, the lines between the sample points may cause ladder-like display. Set **Type** to “Dots” to solve the problem.

7. **Failure to connect to the PC through USB:**

Check the **IO Setting** in **Utility** to make sure that the setting in **USB Device** matches the device currently connected. If changes are made then restart the oscilloscope for the new settings to take effect (cycle the power).

8. **The USB storage device isn't recognized:**

- 1) Check whether the USB storage device is working normally and formatted as FAT32.
- 2) Make sure that the USB interface is work normally. Test is with another USB storage device.
- 3) Make sure that the USB storage device being used is flash storage. This oscilloscope does not support other hardware storage types.
- 4) Restart the instrument and then insert the USB storage device to check it.
- 5) If the USB storage device still cannot be used normally, please contact **Teledyne Test Tools**.



## Company Profile

Teledyne LeCroy is a leading provider of oscilloscopes, protocol analyzers and related test and measurement solutions that enable companies across a wide range of industries to design and test electronic devices of all types. Since our founding in 1964, we have focused on creating products that improve productivity by helping engineers resolve design issues faster and more effectively. Oscilloscopes are tools used by designers and engineers to measure and analyze complex electronic signals in order to develop high-performance systems and to validate electronic designs in order to improve time to market.

The Teledyne Test Tools brand extends the Teledyne LeCroy product portfolio with a comprehensive range of test equipment solutions. This new range of products delivers a broad range of quality test solutions that enable engineers to rapidly validate product and design and reduce time-to-market. Designers, engineers and educators rely on Teledyne Test Tools solutions to meet their most challenging needs for testing, education and electronics validation.

## Location and Facilities

Headquartered in Chestnut Ridge, New York, Teledyne Test Tools and Teledyne LeCroy has sales, service and development subsidiaries in the US and throughout Europe and Asia. Teledyne Test Tools and Teledyne LeCroy products are employed across a wide variety of industries, including semiconductor, computer, consumer electronics, education, military/ aerospace, automotive/industrial, and telecommunications.

Distributed by:



Find Quality Products Online at: [www.GlobalTestSupply.com](http://www.GlobalTestSupply.com)

[sales@GlobalTestSupply.com](mailto:sales@GlobalTestSupply.com)

Product brand or brand names are trademarks or registered trademarks of their respective holders.

T3 stands for Teledyne Test Tools.

07Nov18