

SAC-i

Cat.No.5951

SAC-i 589/882

Cat.No.5952

Automatic Polarimeter / Saccharimeter



SAC-i 589/882

It has become common that dark color - raw sugar samples are measured at 882nm without decolorization treatment.

SAC-i 589/882 can measure samples at both 589nm and 882nm by changing the optical units.

High Performance Sugar Analysis, Now Easier Than Ever.

Here at last – the product of our uncompromising pursuit of ultimate usability.

- FDA 21 CFR Part 11 Software Included in Standard Delivery **NEW**
- Measurement stability in **12 seconds**
(4 seconds in the high-speed & consecutive measurement mode)
- Resolution of up to **4 decimal places**
- Repeatability of **±0.003°** Angle of Rotation and **±0.0090°Z**
- Up to **999** automatic consecutive measurements followed by average value display
- **Sleep & timer feature** to take measurement later at specified time
- Improved usability with the use of **touch screen** technology
- **Connectivity to RX Digital Refractometers** for automatic purity measurement



Mechanism

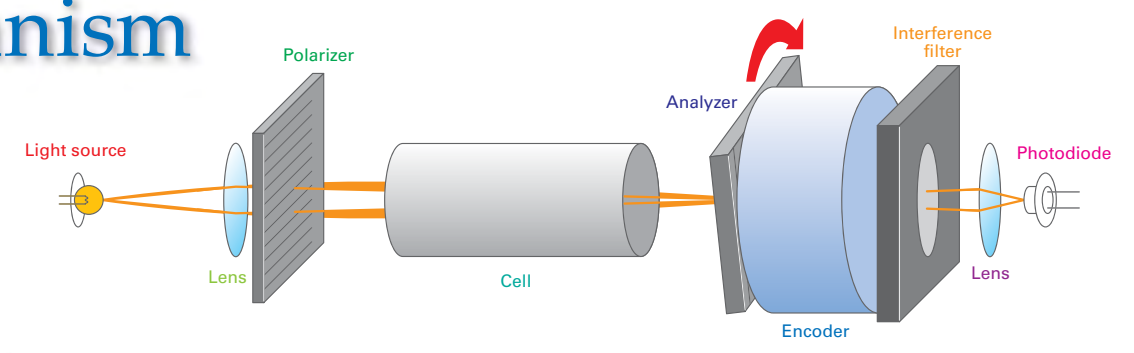

Specifications

SAC-i Cat.No.5951	
Measurement * accuracy	Angle of Rotation: ±0.002° (-5.0000 to +5.0000°) ±0.005° (-45.0140 to -5.0001°, +5.0001 to +45.0140°) International Sugar Scale: ±0.0150°Z (-130.0000 to +130.0000°Z) [Other ranges] Angle of Rotation: ±0.010° International Sugar Scale: ±0.0300°Z
Repeatability *	±0.003° Angle of Rotation and ±0.0090°Z
Measurement wavelength	589nm (equivalent to the sodium-D line spectrum)
Light source unit	LED: 589nm interference filter

SAC-i 589/882 Cat.No.5952	
Measurement * accuracy	589nm: Angle of Rotation: ±0.002° (-5.0000 to +5.0000°) ±0.005° (-45.0140 to -5.0001°, +5.0001 to +45.0140°) International Sugar Scale: ±0.0150°Z (-130.0000 to +130.0000°Z) [Other ranges] Angle of Rotation: ±0.010° International Sugar Scale: ±0.0300°Z 882nm: Angle of Rotation: ±0.005° (-19.3000 to +19.3000°) International Sugar Scale: ±0.0150°Z (-130.0000 to +130.0000°Z) [Other ranges] Angle of Rotation: ±0.010° International Sugar Scale: ±0.0700°Z
Polarizer	Glan Taylor Prism
Measurement wavelength	589nm (equivalent to the sodium-D line spectrum) 882nm (near infrared ray)
Light source unit	LED: 589nm interference filter, 882nm interference filter

* Checked by reading a standard quartz plate.

SAC-i series Common Specifications	
Measurement Scales	Angle of Rotation International Sugar Scale (without temperature compensation) International Sugar Scale (with Automatic Temperature Compensation) Specific Rotation Concentration Purity User scale Angle of Rotation of Quartz Plate (with Automatic Temperature Compensation) Temperature (°C/°F)
Measurement range	Angle of Rotation: -89.9999 to +90.0000° and -360.0000 to +360.0000° International Sugar Scale: -259.0000 to +259.0000°Z
Resolution	Angle of Rotation: 0.0001° International Sugar Scale: 0.0001°Z
Temperature compensation range	10 to 40°C
Temperature display accuracy	±0.2°C
Ambient temperature	Use the instrument where the temperature is between 10 to 40°C
Display method	7.5-inch color LCD + touch screen
Printer output	Digital printer DP-AD/DP-63 (sold separately) Output method: RS-232C (9 pin D-Sub male connector)
Data output to USB flash drive	CSV text file format
Communication with computer	Communication via: USB-Serial
Observation tube included	Observation tubes (100mm [5ml], 200mm [10ml])
Power supply	AC100 to 240V, 50/60 Hz
Power consumption	140VA
Dimensions and weight	60×36.5×21cm, 20.0kg (main unit only)

Dimensions

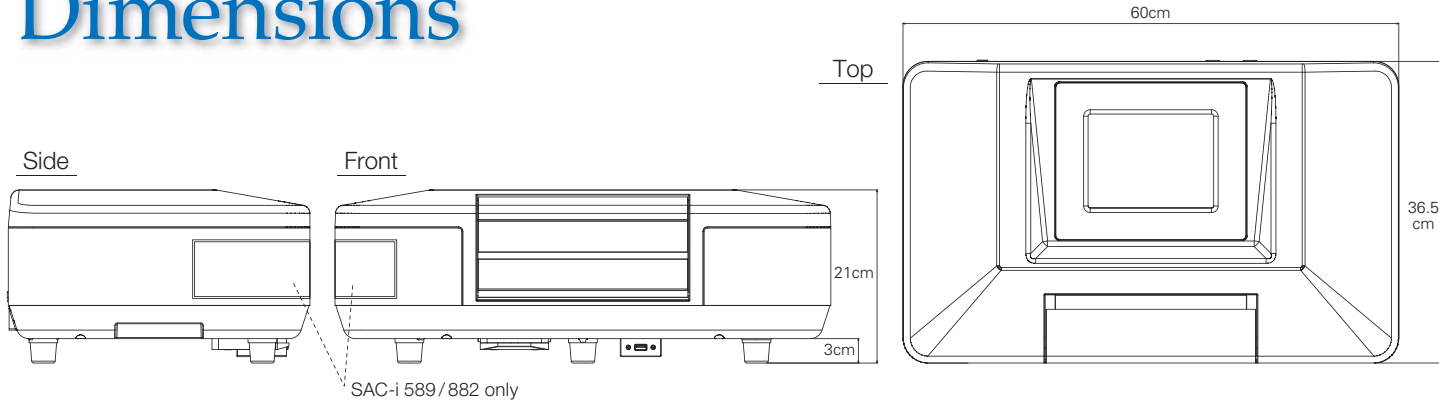

ATAGO CO., LTD.



Find Quality Products Online at:

www.GlobalTestSupply.com

sales@GlobalTestSupply.com

SAC-i

Cat.No.5951

SAC-i 589/882

Cat.No.5952

Automatic Polarimeter / Saccharimeter



Home screen

Choose from a total of 6 options –
3 graphic themes, each with 2 background options.



New Generation Saccharimeter

Accessories



Jacketed flow tube
with funnel

Observation tubes

- RE-72080 : Observation tube 50mm OT-50(l) (SUS) 2.5ml
- RE-72078 : Observation tube 100mm OT-100(l) (SUS) 5ml
- RE-72079 : Observation tube 200mm OT-200(l) (SUS) 10ml
- RE-72113 : Jacketed flow tube with funnel 100mm
- RE-72114 : Jacketed flow tube with funnel 200mm
- RE-72037 : Unjacketed flow tube with funnel 100mm
- RE-72038 : Unjacketed flow tube with funnel 200mm
- RE-72042 : Unjacketed small volume observation tube 10mm long 1ml

- RE-72110 : Jacketed flow tube 50mm
(With water jacket)
- RE-72111 : Jacketed flow tube 100mm
(With water jacket)
- RE-72112 : Jacketed flow tube 200mm
(With water jacket)
- RE-72051 : Unjacketed Flow Tube (Glass) 50mm/4.5ml
- RE-72052 : Unjacketed Flow Tube (Glass) 100mm/9ml

Smooth and Accurate Operations, Guaranteed

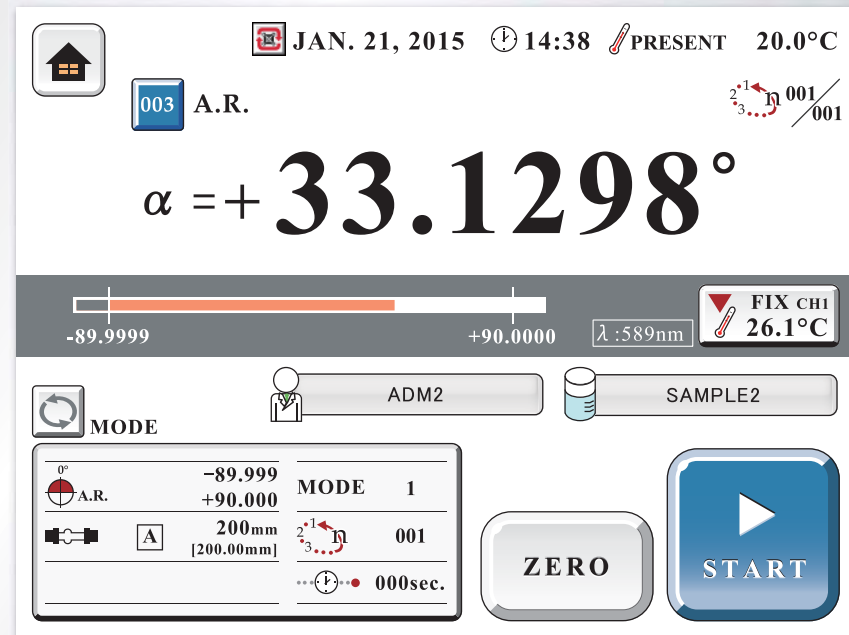

Measurement screen with setting sub-window (lower left)

Basic settings are easily accessible from a sub-window within the main measurement screen. With a touch on the screen, it can switch to display the last 10 measurement history.

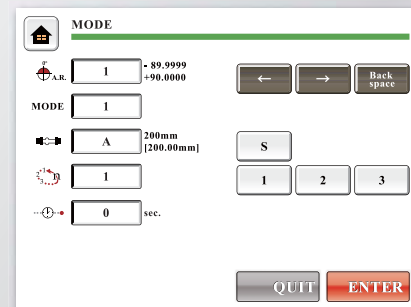

Measurement mode screen

Customize measurement methods – mode, wait time, consecutive measurements, temperature, and more.

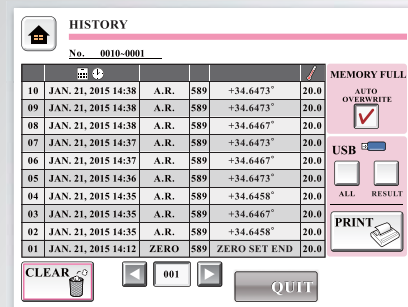

History screen

Up to 5,000 each of measurement and zero-setting / calibration data can be stored.

Touch Screen

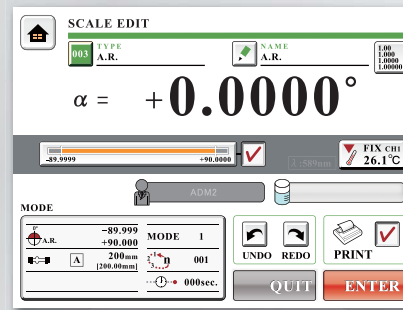

Sale edit screen

Edit and save your own scales with ease.

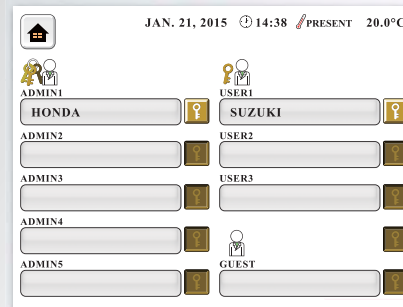

High-security protection

Design your ideal data security system with the 4 system levels in combination with 9 individual user passwords.

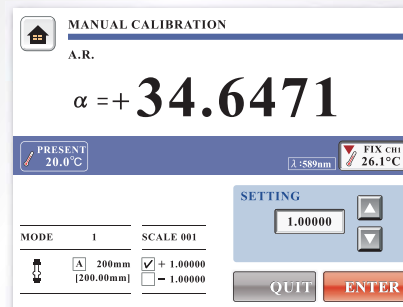

Manual calibration

Correct measurement discrepancies among units within the accuracy specification for consistency across multiple units.

Exceptional Stability & Reliability

Increased repeatability

ATAGO's innovations in technology has made high-stability measurement possible. The repeatability is the best in its class, and sample types that are conventionally difficult to measure can be measured with great repeatability and accuracy.

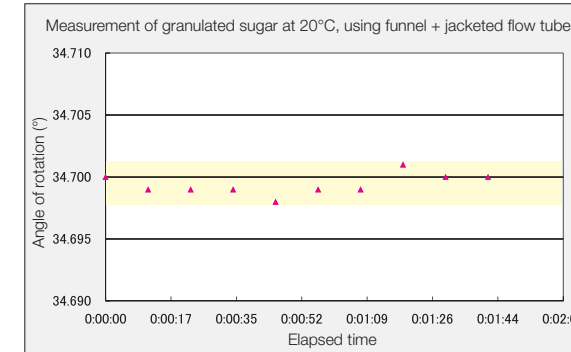

PTB traceability

Manufacturing and calibration is executed with quartz control plates made to the German PTB standards.



Approved by CONSECANA

The SAC-i has passed the vigorous approval process by CONSECANA, the group representing ORPLANA, the Brazilian sugarcane growers association.



User-Friendly Construction



An observation tube length of up to 200mm can be accommodated.



USB ports are easily accessible from the front of the unit.

Hardware



Closed

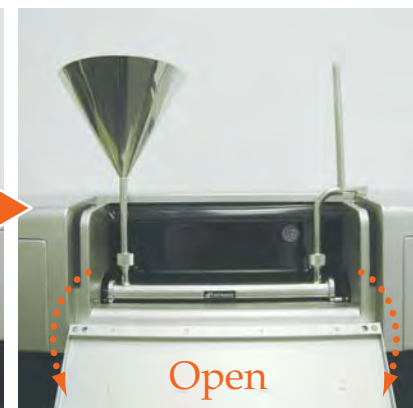

Open

Flow cell (sold separately)

The chamber cover opens forward, allowing for hassle-free installation of the flow cell attachment.

Digital printer

DP-63 Cat.No.3118



Input method	RS-232C
Type of printer	Thermal printing
Printing data fields	Angle of rotation, International Sugar Scale, Specific optical rotation, Concentration, Purity, Length of sample tube, Measurement temperature, Day, Month, Year and Time
Power supply	AC adapter
Power consumption	(Input voltage : AC100 to 240V) 13VA
Dimensions and weight	17×16×7cm, 580g (main unit only)

Digital printer

DP-AD Cat.No.3123



Input method	RS-232C
Type of Printer	Dot matrix printing
Printing data fields	on rolled plain paper (not thermal)
	Angle of rotation, International Sugar Scale, Specific optical rotation, Concentration, Purity, length of sample tube, Measurement temperature, Day, Month, Year and Time
Power supply	AC adapter
Power consumption	(Input voltage : AC100 to 240V) 7VA
Dimensions and weight	11×18×9cm. 470a (main unit only)

Circulating constant temperature Bath

60-C4 Cat.No.1922



Tank capacity	0.5L
Temperature setting range	10 to 60°C (water)
Constant-temperature accuracy	±0.2°C, PID control method using a thermo-module
Flow rate	4L / min.
Power supply	AC100 to 240V, 50 / 60Hz
Power consumption	430VA
Dimensions and weight	38×24×27cm, 11.0kg (main unit only)

Quartz control plates



RE-72043	: Quartz Control Plate 8° (25°Z)
RE-72044	: Quartz Control Plate 17° (50°Z)
RE-72045	: Quartz Control Plate 34° (100°Z)
RE-72048	: Quartz Control Plate -8° (-25°Z)
RE-72049	: Quartz Control Plate -17° (-50°Z)
RE-72050	: Quartz Control Plate -34° (-100°Z)

Included software

FDA 21 CFR Part11 Software

Software for compliance with 21 CFR Part 11 requirements on electronic records and electronic signatures. **Cat.No.3167**



Find Quality Products Online at:

www.GlobalTestSupply.com

sales@GlobalTestSupply.com