



**S661**  
**Rate Counter**  
**Operation Manual**



## About this Manual

To the best of our knowledge and at the time written, the information contained in this document is technically correct and the procedures accurate and adequate to operate this instrument in compliance with its original advertised specifications.

## Notes and Safety Information

This Instruction Manual contains warning headings that alert the user to check for hazardous conditions. These appear throughout this manual where applicable, and are defined below. To ensure the safety of operating performance of this instrument, these instructions must be adhered to.



**Warning, refer to accompanying documents.**

**Attention, consulter les documents d'accompagnement.**



**Caution, risk of electric shock.**

**Attention, risque de choc électrique.**

## Warranty and Returns

SIMPSON ELECTRIC COMPANY warrants each instrument and other articles manufactured by it to be free from defects in material and workmanship under normal use and service, its obligation under this warranty being limited to making good at its factory or other article of equipment which shall within one (1) year after delivery of such instrument or other article of equipment to the original purchaser be returned intact to it, or to one of its authorized service centers, with transportation charges prepaid, and which its examination shall disclose to its satisfaction to have been thus defective; this warranty being expressly in lieu of all other warranties expressed or implied and of all other obligations or liabilities on its part, and SIMPSON ELECTRIC COMPANY neither assumes nor authorizes any other persons to assume for it any other liability in connection with the sales of its products.

This warranty shall not apply to any instrument or other article of equipment which shall have been repaired or altered outside the SIMPSON ELECTRIC COMPANY factory or authorized service centers, nor which has been subject to misuse, negligence or accident, incorrect wiring by others, or installation or use not in accord with instructions furnished by the manufacturer.

Under the normal field usage there is no need to remove the front bezel of this product. The front bezel of this product should only be removed by a qualified technician.

# Contents

1	Product Description. . . . .	3
1.1	General Description. . . . .	3
1.2	Part Number Identification. . . . .	4
1.3	Option Module Summary. . . . .	4
2	Hardware Setup. . . . .	6
2.1	Panel Installation. . . . .	6
2.2	Removing / Installing Option Modules. . . . .	7
2.3	120/240 VAC Power Module. . . . .	8
2.4	Standard Input Module. . . . .	8
2.5	Quadrature Input Module. . . . .	11
2.6	Excitation Module. . . . .	14
2.7	Single and Dual Relay Modules. . . . .	15
3	Display & Keypad Controls. . . . .	16
3.1	Display. . . . .	16
3.2	Display Error Messages. . . . .	17
3.3	What the Keys Do in Display Mode. . . . .	18
3.4	What the Keys Do in the Programming Mode. . . . .	18
3.5	Special Start-Up Modes. . . . .	21
4	Counter Operations and Parameters. . . . .	21
4.1	Password and Security Controls. . . . .	22
4.2	A/B Channel Options. . . . .	23
4.3	Rate (Frequency) Scaling and Display. . . . .	25
4.4	Output Control Modes. . . . .	27
4.5	Set Point Parameters. . . . .	28
4.6	Miscellaneous Controls. . . . .	29
	Appendix A: Technical Specifications. . . . .	30
A.1	Functional Specifications. . . . .	30
A.2	Electrical, Environmental and Mechanical Specifications. . . . .	31
	Appendix B: Programming Quick Reference. . . . .	33

# 1 Product Description



## 1.1 General Description

The S661 rate counter fits a 1/8 DIN standard cutout and is perfect for tight spaces, extending only 3.24" (82mm) behind the panel. The unit is UL listed. The unit is for indoor use at altitudes up to 2000m, temperatures between 0° and 40°C and installation category III, pollution degree 2.

The counter is powered from 120 or 240 VAC. The nonvolatile EEPROM retains all programming and count information when power is removed or interrupted.

Display scaling, preset values and all menu functions are easily programmed from the front panel, following easy-to-use word prompts. Front panel reset disable and password lockout protection features guard against unauthorized or accidental changes.

The counter accepts count rates up to 30 kHz and pulses from different types of sensors, including Quadrature, CMOS or TTL circuits and PNP or NPN devices.

The optional, field-replaceable single/dual relay module enhances the counter from a passive display device to an integral control element for your application. The counter has latching, boundary or timed (0.01 to 599.99 seconds) output modes.

An optional 12 VDC (100mA) excitation output module can provide power for external sensors.

## 1.2 Part Number Identification

The following matrix indicates the configuration of your S661 counter.

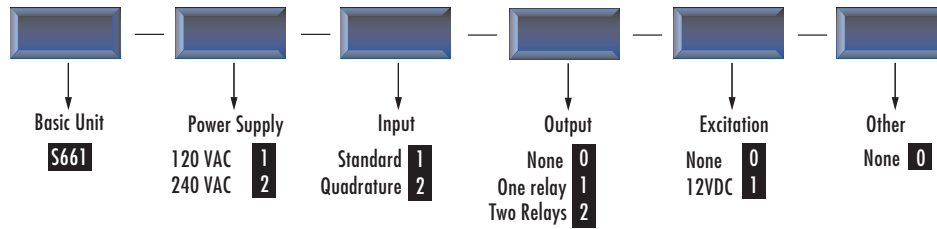

## 1.3 Option Module Summary

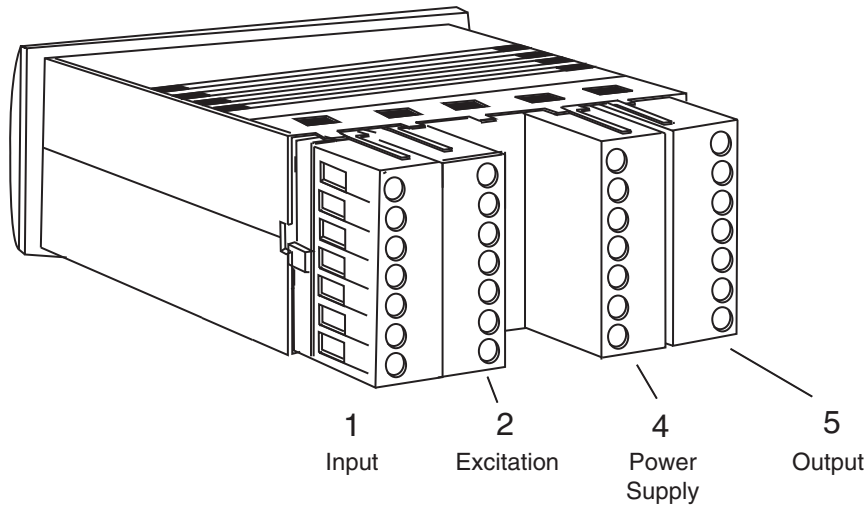

Figure 1. Option Module Slots (Rear View)

The S661 is a modular product which uses field configuring slide-in modules. The modules slide easily into the rear of the counter.

Figure 1 displays the functional assignments for each module position.

Table 1 describes available option modules for the S661.

Table 1. Option Module Summary

<b>Module slot</b>	<b>Type</b>	<b>P/N</b>	<b>Description</b>	<b>See Section</b>
1	Input		Standard Input Module	<b>2.4</b>
1	Input		Quadrature Input Module	<b>2.5</b>
2	Ext	45064	12 VDC Excitation Module	<b>2.6</b>
4	Power		120 VAC Power Module	<b>2.3</b>
4	Power		240 VAC Power Module	<b>2.3</b>
5	Output	45062	Dual Relay Module	<b>2.7</b>
5	Output	45063	Single Relay Module	<b>2.7</b>

## 2 Hardware Setup

### 2.1 Panel Installation

The S661 1/8 DIN counter requires a standard 1/8 DIN panel cutout of 1.77" (45mm) high by 3.62" (92mm) wide. To install the counter into a panel cutout, remove the clips from the side of the counter. Slide the counter through your panel cutout, then slide the mounting clips back on. Press evenly to ensure a proper fit.

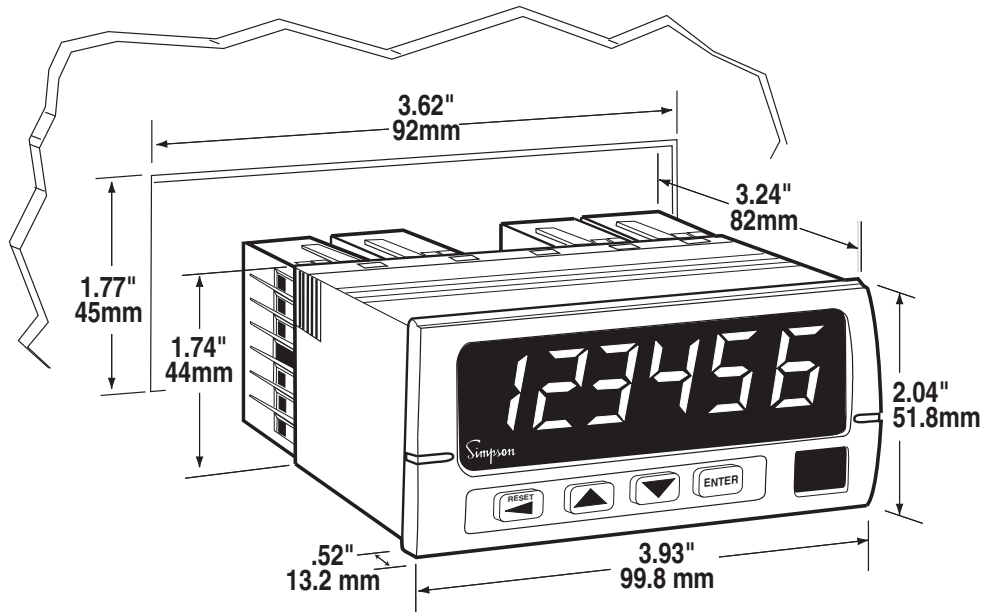

Figure 2. Counter and Panel Cut-Out Dimensions

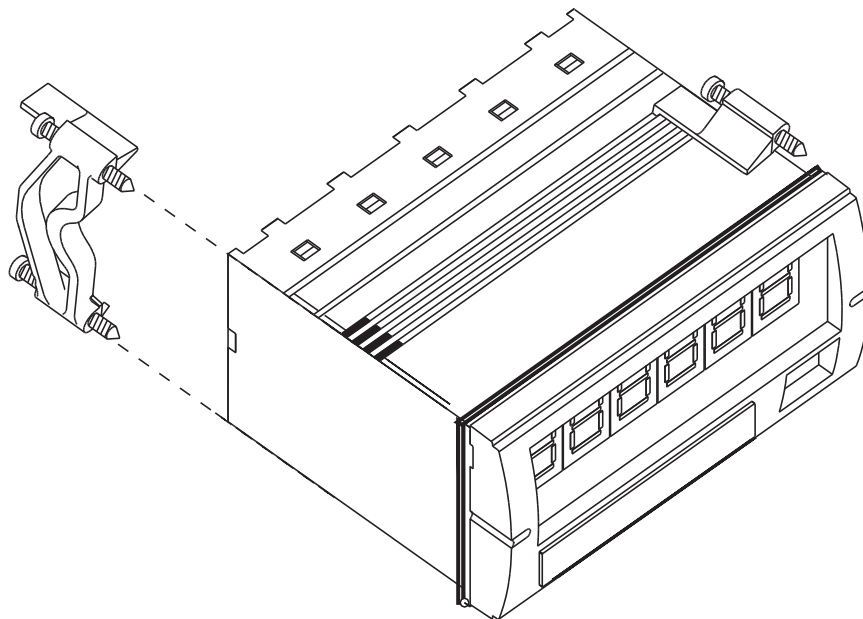
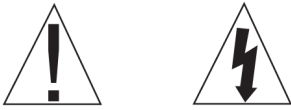

Figure 3. Panel Mounting Clips

## 2.2 Removing / Installing Option Modules



**Shut power off before removing or installing any option modules**

**Couper le courant avant de retirer ou d'installer des modules optionnels**

1. Remove module from case by inserting a screwdriver into tab slot opening at top of input module. Apply pressure to release module from case. Repeat procedure for tab located on underside of module and then slide module away from the case.
2. Refer to appropriate sections to configure switches or jumpers for proper operation. Table 1 can be used to identify modules and their associated detail paragraph.
3. Install module by carefully aligning module edges with slots in case and pressing forward until tabs (on top and bottom) engage.

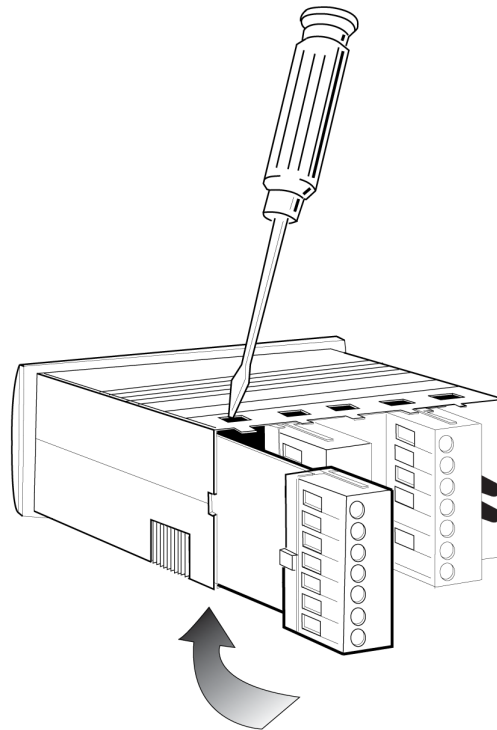

**Figure 4. Removing Option Module**



### 2.3 120/240 VAC Power Module



**Remove power before wiring option modules.**

**Coupez l'alimentation avant de raccorder les modules optionnels.**

The AC power module allows the S661 to be operated from standard 50/60 Hz line power. The power module will be configured as 120 VAC or 240 VAC per markings on the back panel. Ensure the input rating of the supply matches your line voltage. The power supply module has provisions for a hard-wire Alarm Reset. This control can be a switch, relay contact or solid state device. Actuation is immediate upon an active Low for at least 2.5ms to this terminal. The reset circuit is independent of the power circuit.

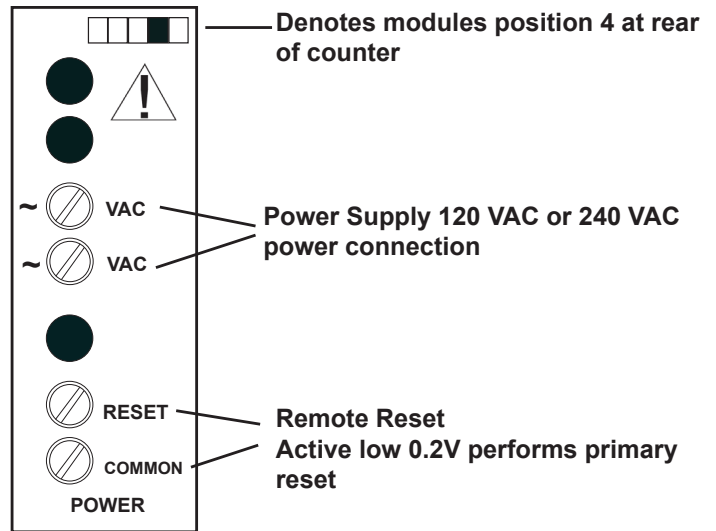

**Figure 5. AC Power Module**

**NOTE: A fusible link is not provided on this module.**

**A ½ Amp Time Delay fuse, Bussman MDL ½, or similar is required.**



**Never connect AC mains (hot or neutral) to the Reset or Common terminals!**

**Ne jamais brancher sur secteur (chaudes ou neutres) pour la réinitialisation ou terminaux communs!**

### 2.4 Standard Input Module

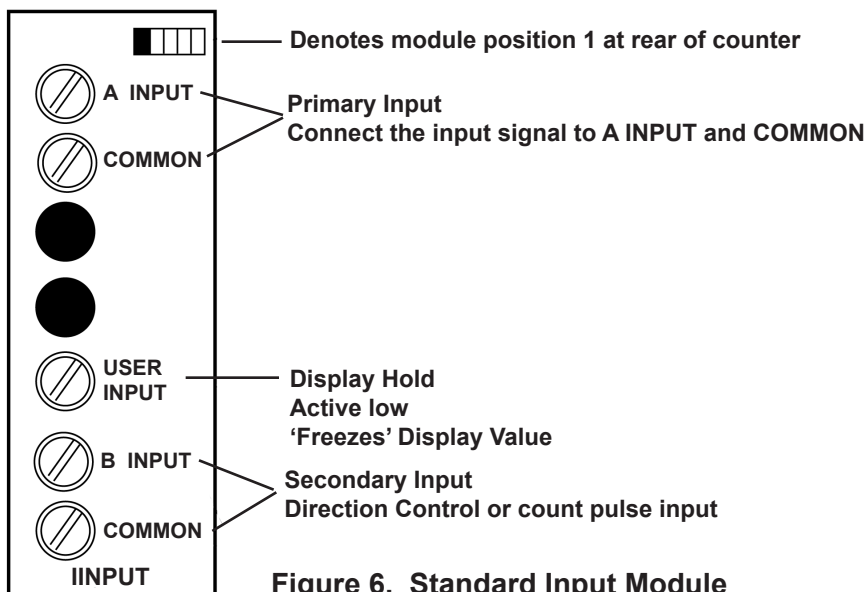

**Figure 6. Standard Input Module**

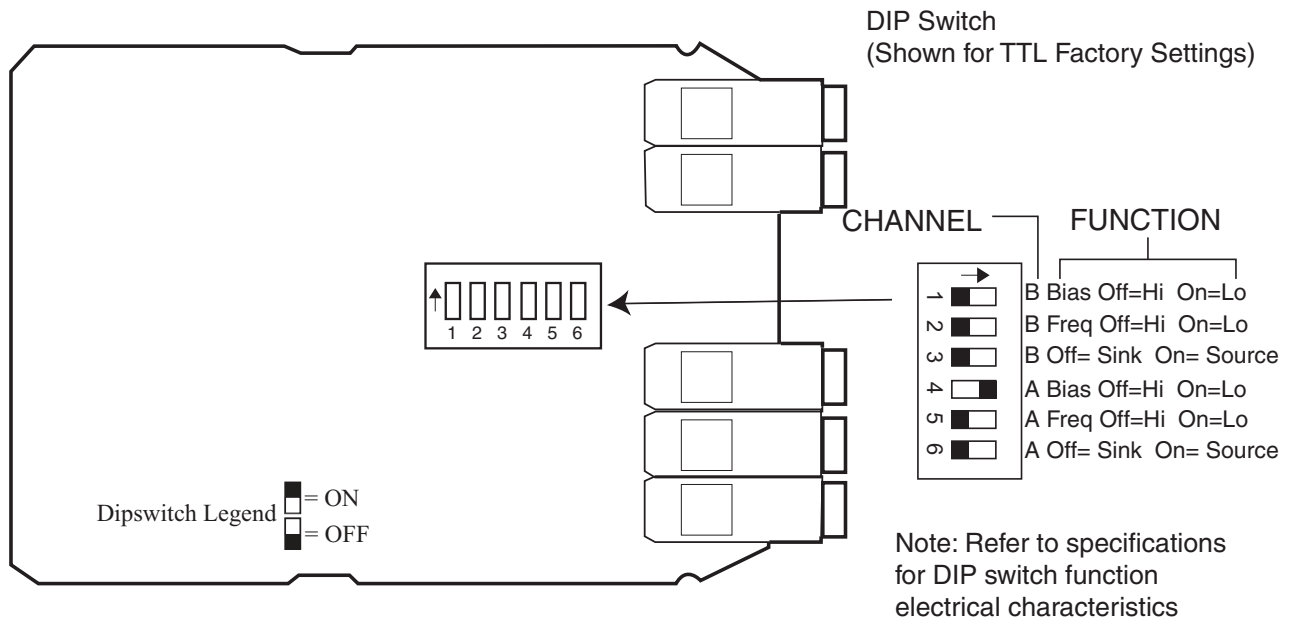

Figure 7. Standard Input Module Default Settings

DIP switch SW1, figure 7, is used to set up the counter to conform to the electrical characteristics of the sensor or signal being detected. Switch positions 1-3 configure channel B, while switches 4-6 configure channel A. These switches select bias (threshold voltages), low pass filter (enable/disable) and sensor type (Sink or Source).

Refer to the documentation that accompanied the sensor for related information. The sensor can most likely be matched to one of the typical switch settings shown in figure 8 and figure 8a.

**Note: The input boards are designed so that selecting sourcing or sinking is based on the type of sensor that is being used. If a PNP (sinking) sensor is being used, set the input board for sinking also (switched 3 and 6 = OFF).**

If channel B is not used, default settings for switch positions 1 through 3 should be selected. Default settings are provided in Table 2.

The input module also provides for a user input signal. On the S661, this input performs a Display Hold. While active, the rate value shown on the display is "frozen." Internal measurements and output controls continue to operate.

The S661 can accept inputs from many different sensors. The A and B channels may be configured independently as shown in Table 2. Figures 8 and 8a have examples of some typical sensors and the wiring connections that would be used.

Table 2. Standard Input Module DIP Switch Settings

\* = Factory Default setting

1 B Channel Bias:	OFF =	Hi*	VLT = 5.0 V	VUT = 7.0V	(+/- 10%)
	ON =	Low	VLT = 1.6 V	VUT = 3.6V	(+/- 10%)
2 B Channel Frequency:	OFF =	Hi*	(low pass filter disabled)		
	ON =	Lo	(low pass filter enabled)		
3 B Channel Sensor:	OFF	=	Sinking*	(internal pull-up enabled)	
	ON =		Source	(internal pull-down enabled)	
4 A Channel Bias:	OFF =	Hi	VLT = 5.0 V	VUT = 7.0V	(+/- 10%)
	ON =	Low*	VLT = 1.6 V	VUT = 3.6V	(+/-10%)
5 A Channel Frequency:	OFF =	Hi*	(low pass filter disabled)		
	ON =	Lo	(low pass filter enabled)		
6 A Channel Sensor Type:	OFF =	Sinking*	(internal pull-up enabled)		
	ON =	Source	(internal pull-down enabled)		

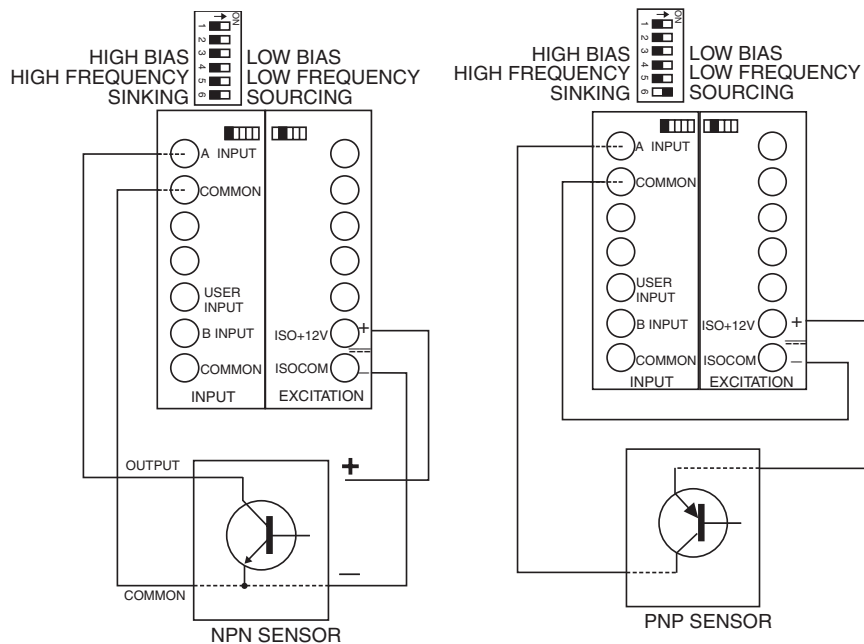

Figure 8. Sensor Connection Examples

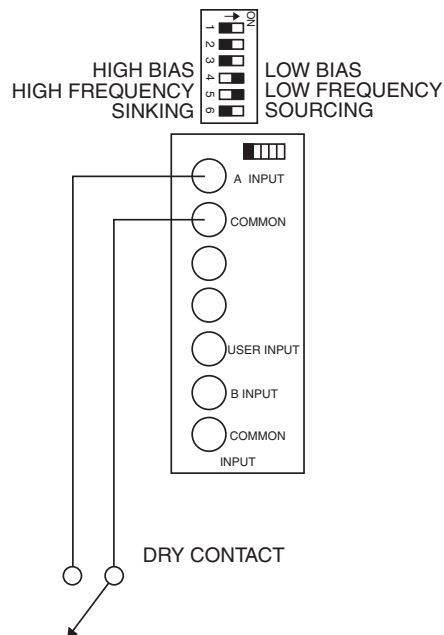

Figure 8a. Sensor Input example

## 2.5 Quadrature Input Module

The Quadrature / Universal Input Module has two operational modes: Quadrature mode and Standard mode. Quadrature mode is selected by positioning JP1 and JP2 on pins 1 and 2. Standard mode is selected by placing JP1 and JP2 on pins 2 and 3 (see Figure 10 for details). The Quadrature mode supports a wide range of encoders including the Simpson SE series.

While in Standard mode, this module works similarly to the Standard Input module, with the added capability to selectively invert A, B, and User input signals. The Input module also provides for a User input signal. On the S661 this input serves as a Display Hold. While active, the rate value shown on the display is “frozen.” Internal measurements and output controls continue to operate.

**NOTE: If B channel is not going to be used, use the default switch settings for SW1 positions 1 through 3. Default settings are provided in Table 3.**

In both modes, the state of the User input signal can be selected as active high or active low. DIP switch SW1 configures the counter to match the specifications of the accompanying sensor. When shipped from the factory, the counter is set for X1 quadrature, as shown in Figure 10 and Table 3:

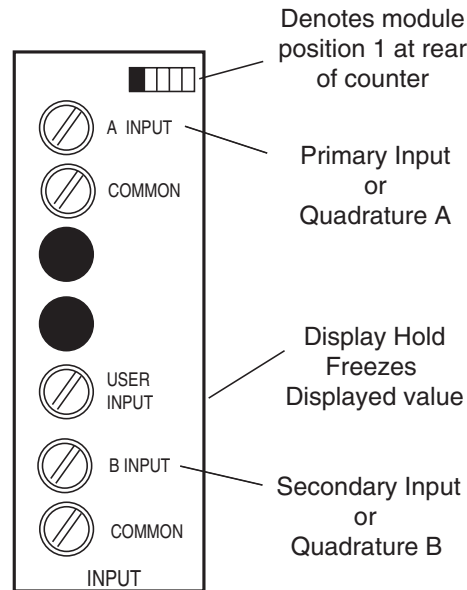

Figure 9. Quadrature / Universal Input Module

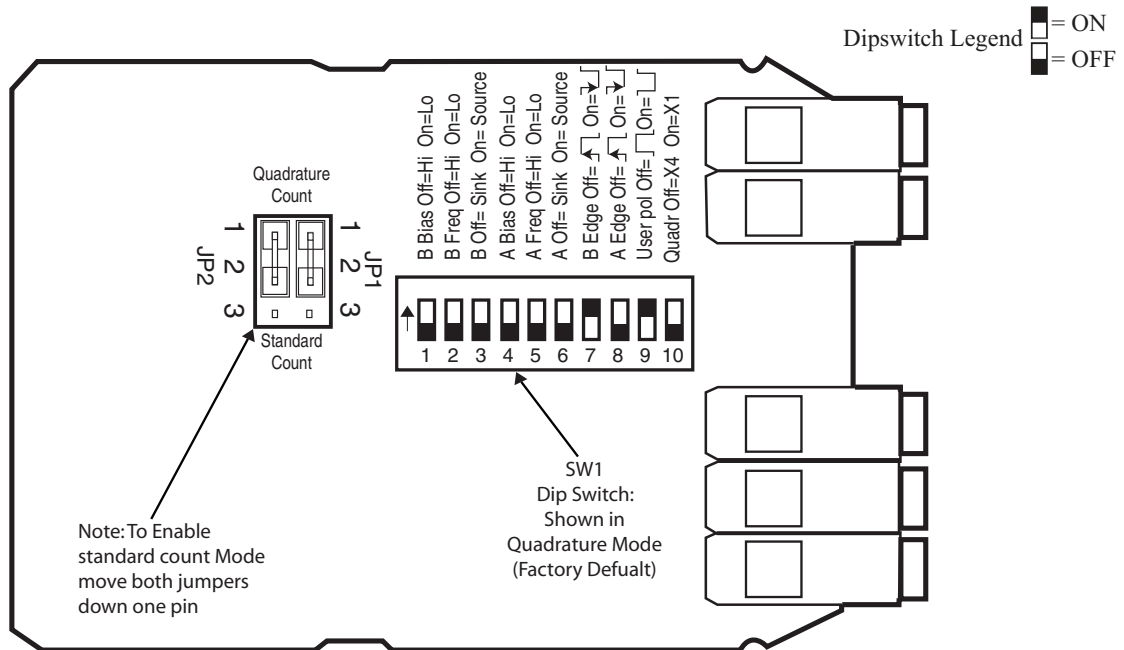

Figure 10. Quadrature Input Module Default Settings

Table 3. Quadrature Module DIP Switch and Jumper Settings

JP1/2: Count Mode Selector

Jumpered 1-2 = Quadrature mode\*\*

Jumpered 2-3 = Standard counter mode

SW1: 10 Position DIP Switch

\* = Factory Default setting

1 B Channel Bias:	OFF =	Hi*	VLT = 5.0V	VUT = 7.0V (+/- 10%)
	ON =	Low	VLT = 1.6V	VUT = 3.6V (+/- 10%)
2 B Channel Frequency:	OFF =	Hi*	(low pass filter disabled)	
	ON =	Low	(low pass filter enabled)	
3 B Channel Sensor:	OFF =	Sinking*	(internal pull-up enabled)	
	ON =	Source	(internal pull-down enabled)	
4 A Channel Bias:	OFF =	Hi*	VLT = 5.0 V	VUT = 7.0V (+/- 10%)
	ON =	Low	VLT = 1.6 V	VUT = 3.6V (+/- 10%)
5 A Channel Frequency:	OFF =	Hi*	(low pass filter disabled)	
	ON =	Lo	(low pass filter enabled)	
6 A Channel Sensor Type:	OFF =	Sinking*	(internal pull-up enabled)	
	ON =	Source	(internal pull-down enabled)	
7 B Channel Count Edge:	OFF =	Rising	(standard count mode only)	
	ON =	Falling*		
8 A Channel Count Edge:	OFF =	Rising	(standard count mode only)	
	ON =	Falling*		
9 User Input Polarity:	OFF =	High/open circuit	= Inhibit Count	
	ON* =	Low/closed circuit	= Inhibit Count	
10 Quadrature Mode:	OFF =	X4	(quadrature mode only)	
	ON =	X1*		

## 2.6 Excitation Module

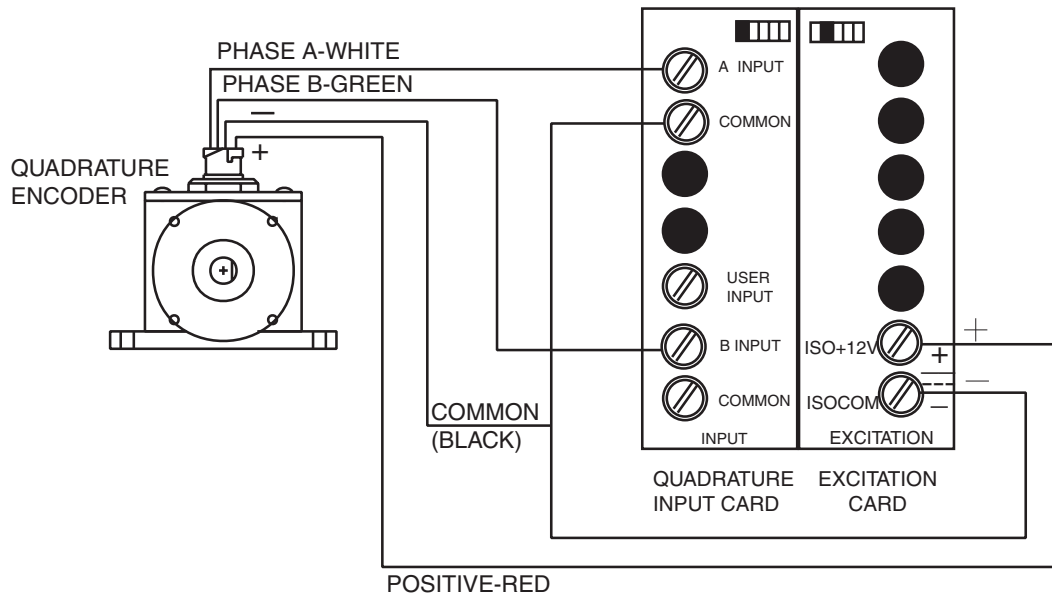

Figure 11. Wiring Encoder w/ Excitation Supply  
12 VDC Excitation Module

The Excitation Module can supply 12 VDC at up to 100 mA for external sensors or encoders. This excitation is isolated from the counter internal logic supply. When using sensors or encoders that do not have a signal return or imply a signal return that is in common with the supply voltage, a common attachment that ties the excitation supply to the logic input common may be required. Examples of this appear in figures 8, 8a, 11 and 12.

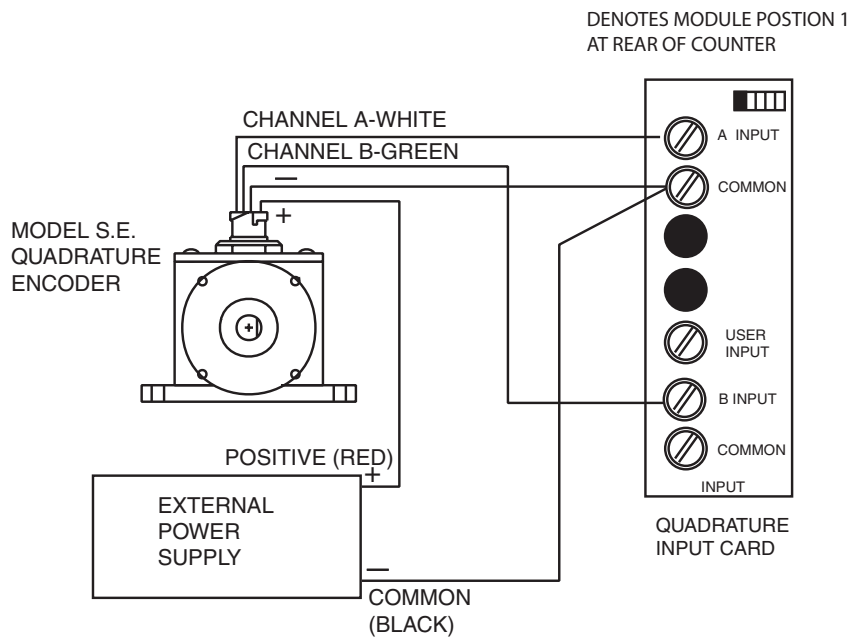

Figure 12. Wiring Encoder with External Supply

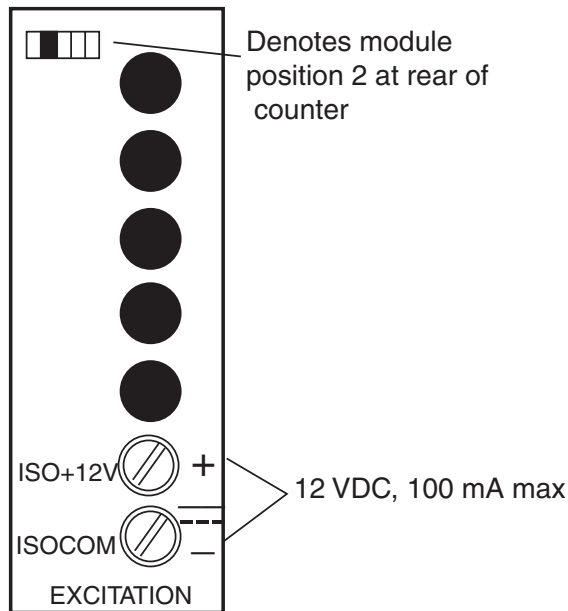

Figure 13. Excitation Module

## 2.7 Single and Dual Relay Modules

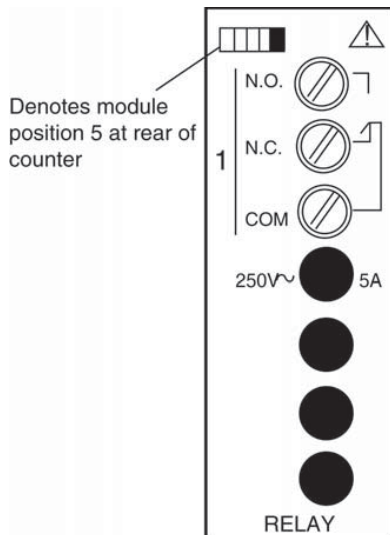

Figure 14. Single Relay

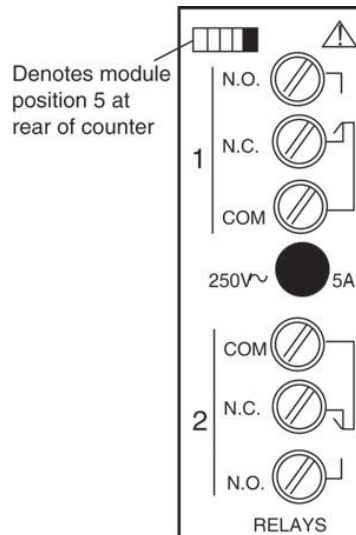

Figure 15. Dual Relay

The Single and Dual Relay modules can activate circuit loads of up to 5 amps at 250 VAC. A Form C configuration allows use of normally-open (NO) and normally-closed (NC) circuit action.

Only the output 1 channel is implemented in the single relay module.



## 3 Display & Keypad Controls

### 3.1 Display

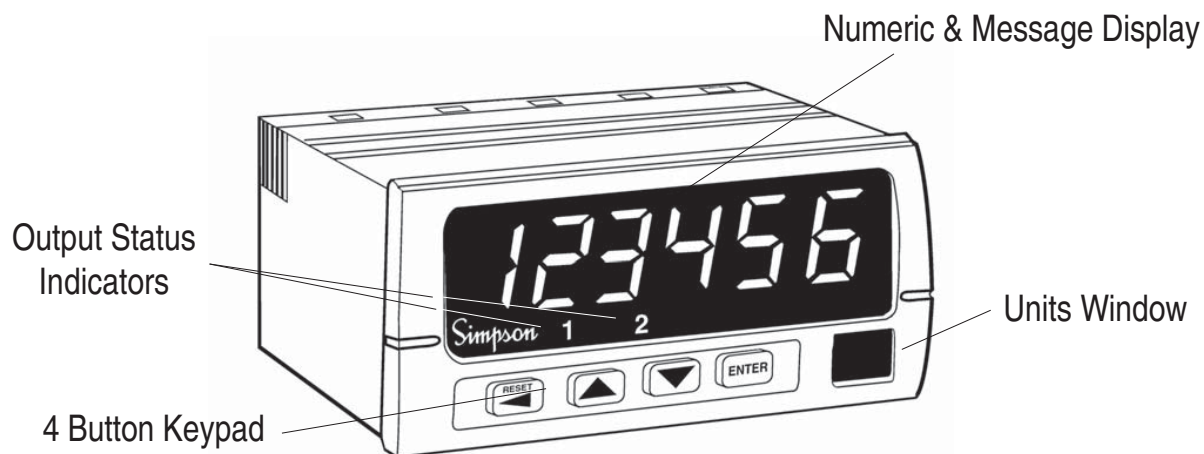

Figure 16. Display and Keypad Layout





- 6-digit 0.56" high red LED display.
- 2 Output Status Indicators; "1" and "2."
- Units Window for supplied label or legend.
- 4-Button keypad with tactile response.

## 3.2 Display Error Messages





Table 4. Display Error Messages

Display	Description	Action Required
PRdErr	The Keypad is disabled or a key is stuck in the ON position	Cycle power to the counter, if the error remains, return counter to factory for repair.
999999 or -999999 (Flashing)	The displayed count is too large for the counter to display. Since the internal count buffer is much larger than the display, the counter will maintain accurate count and control well beyond the display value.	Reset Counter
E1 (Outputs deactivate, count stops)	<b>Raw Count Overflow:</b> The number of count pulses has exceeded the counter's maximum internal value (2,147,483,648 or -2,147,483,648)	Reset Counter
E2 (Outputs deactivate, count stops)	<b>Math Overflow:</b> A large scale factor in combination with large raw count has exceeded the counter's maximum internal value (+2,147,483,648 or -2,147,483,648)	Reset Counter
E3 (Outputs deactivate, count stops)	<b>Watchdog Fault:</b> The counter did not experience an orderly power-down. This can happen by exceeding the maximum allowable count speed for a sustained period of time.	Reset Counter

### 3.3 What the Keys Do in Display Mode

Key	Keypad behavior
 or 	Allows quick access to all the set points. This feature can be disabled by using a password (see section 4.1).
Hold  and  Press 	Access the Programming Menu.

### 3.4 What the Keys Do in the Programming Mode

Key	Keypad behavior
	Press and hold for four seconds to exit the programming mode.
 or 	The up and down keys navigate through the available menu functions. The menu 'wraps around' when the bottom or top of the menu is reached.
	1) Enter the current menu or parameter to view/edit. 2) Write the change to the counter memory and move to the next function.

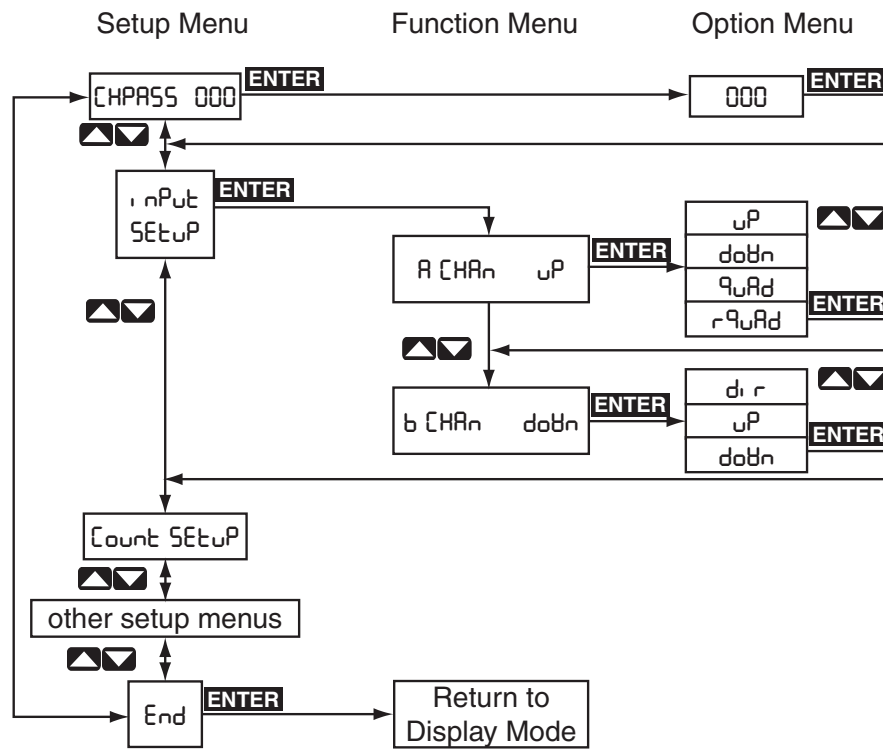

Figure 17. Programming Menu Structure

In the Programming Mode, the S661 will return to Display Mode automatically if a key is not pressed within 120 seconds (2 minutes). The menu is comprised of three levels: Setup Menu, Function Menu and Option Edit Menu. Figure 17 illustrates the three levels of the menu system.

**Password Entry** Entry (Pass) and changing of the password (Chpass) are similar to editing a numerical parameter. See Numerical Value below. If the password has been set to a value other than “000,” entry of the proper password is required to access the remainder of the menu.



**Setup Menu** At the first level of the menu, the arrow keys navigate up or down through the available Menu selections.

**Function Menu** The second level of the menu contains the functions or software parameters that need to be configured for the counter to operate properly





**Option Menu** Contains either Choice Lists or Numerical Values for configuring the counter

## Choice List

A Choice list allows one to select from a fixed number of options. A Choice List is found in the Options section of the menu. This list is made up of the available options for the function that is being edited. Example: Menu is Input Setup Menu, the Function is A Channel, the Choice List is up, down, quad and rquad (see Table 6).

Key	Keypad behavior
 	The up and down keys scroll through the available choices in the Choice list.
	Saves the current choice as new parameter setting and steps to next parameter or category.

Numerical Value A numerical entry allows the changing of set point values, scale values, etc.



Key	Keypad behavior
	Selects the next digit to the left of the current flashing digit for editing.
 or 	The up and down keys increment or decrement the flashing digit. Some parameters support negative numbers. In these cases, the most significant digit can be made negative by incrementing it past "9."
	Saves the values as the new setting for the function in memory and advances to the next function of the menu automatically.

### 3.5 Special Start-Up Modes

There are two start-up modes for the S661 counter. The default start-up mode will be used every time the counter is powered up by the user. There is one alternate start-up mode that will allow the operator to return the counter software functions to factory default settings.

The alternate start-up modes can only be accessed by pressing and holding certain keys during the power up sequence.

- Press and hold both keys on the face of the counter
- Apply power while holding keys

Key	Keypad behavior
 and 	Returns parameters to factory defaults. Resets password to 000, and all user scaling, operation modes and set points to factory defaults. The display will show <code>FrESEt</code> .

## 4 Counter Operations and Parameters

This section details the programming options of the S661, presuming all defaults are in place.

If you are already familiar with the S661 programming, see Appendix B for the Programming Quick Reference Guide.

To enter the Programming Mode, hold  and press .

To return to the Display Mode, press  and hold for four seconds.

## 4.1 Password and Security Controls

The security feature helps prevent accidental changes to counter settings.

The password value determines the counter's security level, as shown in Table 5.

If you have forgotten the password, see section 3.5; Special Start-Up Modes.

- 1) After entering the Programming Mode, the first field is Password.
  - a) If no password has been assigned, the counter will flash between chpass, for "Change Password," and the default value, 000.
  - b) To change the password, press **ENTER** when the display shows 000. Use the arrow keys to change the flashing digit to the desired number.
  - c) Press **RESET** to advance to the next digit. Press **ENTER** to accept the password to counter memory and press it again to advance to the next parameter, Input Setup.

Table 5. Password Values

Password Value	Level of Security
000	No Security - Default setting Allows full access to the Programming Menu and Quick Access to set points is enabled.
001 - 099	Fully secure The Programming Menu is secured by password and Quick Access to set points is disabled.
100 - 999	Quick Access Only Programming Menu is secured by password, Quick Access to set points via up and down keys enabled.

- 2) If a password is already in the counter, the display will flash between pass, for “Enter Password,” and the default value, 000.
  - a) When the display shows 000, press **ENTER**. Use the arrow keys to change the flashing digit to the desired number. Press **RESET** to advance to the next digit.
  - b) Press **ENTER** to enter the password as shown. If an incorrect password is entered, access denied will flash on the display. Press an arrow key to return to the pass display.
  - c) After entering the correct password, the counter will return to chpass. Press **ENTER** to change password, or press the **▼** key to continue to the Input Setup menu category.

## 4.2 A/B Channel Options (Input Setup)

The next category in the Programming Mode is the “Input Setup.” Here you can adjust the A and B channels to the appropriate count modes.

The A channel input may be selected as an Up, Down, Quadrature or Reverse Quadrature\* input.

As an Up channel, pulses applied to the A input are added to the display. In Down mode, subtraction occurs. Note that when using Quadrature inputs, appropriate hardware (jumper) settings may be needed.

\* The Reverse Quadrature input allows the user to reverse the count direction of the encoder in software instead of having to rewire/remount the encoder.

Table 6. Channel A Selection

A CHAN	Direction	B CHAN
UP	Up	User defined
DOWN	Down	User defined
QUAD	Up	Not Available
R QUAD	Down	Not Available



- 1) To set the A Channel value:
  - a) When the display flashes input setup, press **ENTER**. The display will change to a chan.
  - b) Press **ENTER** again to proceed to the choice list. Scroll through up, down, quad, and r quad using the arrow keys.
  - c) When the selection is complete, press **ENTER** to accept the selection to counter memory, and press again to proceed to the next parameter, Chan B Mode.

The B channel may be set as Up, Down or Direction. In the direction mode, the B channel is no longer a count source, but controls the count direction of the A channel input. This state control works as an 'exclusive-or' with the channel A direction. Thus, if B input is in the 'Down' state and A channel is set to Down, pulses at the A input will increment count.

A Channel Setting	State at B Input	Resulting Count
UP	UP	UP
UP	DOWN	DOWN
DOWN	UP	DOWN
DOWN	DOWN	UP

Table 7. Count Behavior with B Channel Set as Direction Control

When A channel has been set to either Quadrature or Reverse Quadrature settings, the B channel internally behaves as a direction control.

- 2) To set the B channel:
  - a) In the Input Setup area, after entering the A Chan value, the display will flash between b chan and the counter's default (dir).
  - b) When the display shows dir, press **ENTER**.
  - c) Use the arrow keys to change the value, then press **ENTER** to accept the selection and proceed to the next menu category, Count Setup.

**NOTE: The B channel will not show in the menu when Quadrature or Reverse Quadrature has been selected for the A Channel input.**





### 4.3 Rate (Frequency) Scaling and Display (Rate Setup)

One of four rate modes may be selected to best accommodate input frequencies ranging from 0.00278 Hz to 30 kHz. Select the rate mode according to Table 8.



Range (implied scale)	Typical Update Period	Min. Input Frequency	Max. Input Frequency	Comments / Typical Application
mSec (Hz ÷ 1000)	1.0 sec	1 Hz	30 KHz	1/1000 Hz resolution / High precision measurement of power line frequency
Sec (Hz x 1)	0.5 sec	2 Hz	30 KHz	1 Hz resolution / Typical Setting for most applications
Min (Hz x 60)	3 sec	20 Counts/Min	1.2M Counts/Min	Use when measuring 'units per Minute'
Hr (Hz x 3600)	90 sec	40 Counts/Hr	3.0M Counts/Hr	Measures 'units per Hour'. Also for very low frequencies.

Table 8. Rate Mode Selection





Rate can also be displayed as a signed entity and will be negative according to the direction state (see section 4.2). When B channel is configured for up or down count input, the rate is the sum of the frequencies at A and B with the polarity of rate determined by the A channel up/down mode.

- 1) To set the rate mode, enter the Programming Mode and press  until the rate setup menu category is reached.
- 2) Press  to continue to the parameter name rmmode. The display will flash between rmmode and the default setting sec. When the display shows sec, press .
- 3) Use the arrow keys to scroll through the choices (mm sec, sec, mmin, hr). Press  when the correct mode is selected to accept mode and proceed to next parameter, Scale.





#### Rate Scale

- 1) At scale, the display will flash between rscale and the default 01.0000, when the display shows 01.0000, press .
- 2) Use the arrow keys to select the correct value for the flashing digit, press  to advance to the next digit.
- 3) When the correct value is displayed, press  to accept and proceed to next parameter, Rate DP.

#### Rate Decimal Point Position

- 1) To set the Decimal Point position, enter the Programming Mode, and press  until the rate setup menu is reached.
- 2) Press  to continue to the Parameter Name rat dp. The display will flash between rat dp and the default 000000. When the display shows 000000, press .
- 3) Use the arrow keys to scroll through the choices. Press  when the correct decimal place is selected to accept value and proceed to the next parameter name, Rate Offset.

## Rate Offset

- 1) To set the Rate Offset, enter the Programming Mode, and press  until the rate setup menu is reached.
- 2) Press  to continue to the Parameter Name offset. The display will flash between offset and the default 000000. When the display shows 000000, press .
- 3) Use the arrow keys to select the correct value for the flashing digit, press  to advance to the next digit.
- 3) When the correct value is displayed, press  to accept and proceed to next menu category, Output 1 Mode.

Examples for Rate Mode, Rate Scale, Rate Decimal Point Position and Rate Offset are on following pages:

Description	Value	Formula Value
Pulses per second seen at input	10000	Input Frequency
Mode 2 = x1 sec/Hz	sec	Mode
User-entered Multiplier	.5000	Scale
User-entered additive value	100.00	Offset
Decimal Position	0000.00	DP

Table 9. Rate Example

The input frequency can be linearly scaled using the Scaling Multiplier, Offset and Decimal Point. The rate channel has an offset value as well. To illustrate, the following example will be used:

- 1) Multiply Input Frequency by implied Mode multiplier  
 $10000 \times 1 = 10000$
- 2) Multiply by user-specified Scale:
- 3) Discard all digits to right of decimal place:  
 (If number is larger than six digits, it will not fit in the display)  
 $5000$
- 4) Apply the user-specified DP location:  
 $50.00$
- 5) Add user-specified Offset location:  
 $250.00 - 100.00 = 150.00$   
 (That is what will be seen of the display)

The following notation may be used to describe this behavior:

Display = INT [Fint x Scale] DP + Offset

## 4.4 Output Control Modes





The S661 supports two independent output channels with four modes of operation: disabled, timed, latched and boundary.

Output Type	Description
<b>Disabled Output</b>	The output channel is inactive.
<b>Timed Output</b>	<p>The timed mode activates an output when a set point or 'trigger' condition is reached. Once active, the output is held for a specified delay period. The delay may be between 0.01 and 599.99 seconds.</p> <p>The output will activate when the specified value is encountered (SP1 for output 1, SP3 for output 2). If a timing period is in progress, a new trigger does not occur. This is referred to as a non-retriggereable timer. A RESET will cancel the timed output.</p>
<b>Latch Output</b>	<p>The latch mode activates an output when a 'trigger' or set point is reached.</p> <p>The output will activate when the value is encountered (SP1 for output 1, SP3 for output 2). Once activated, the output is held and can be deactivated only when the specified Latched Until condition is met. The Latched Until conditions can be seen in Table 10.</p>
<b>Boundary Output</b>	<p>The Boundary mode differs from the other output types in that it allows the counter to have an output activate/deactivate automatically within a specified range.</p> <p>Boundary mode activates an output when the count is between the specified low and high set points (SP1/SP2 for output 1, SP3/SP4 for output 2.)</p>

Latch Until	Description
Reset	A front panel or external reset event is required to deactivate the output.
SP#	Output deactivated when set point is encountered.
RstPos	Output deactivated when reset position is encountered.

Table 10. Latch Until

**NOTE:** The outputs for this counter activate regardless of count direction in all count modes.

- 1) To set the Output Control modes, enter the Programming Mode, and press  until the oput 1 setup menu category is reached.
- 2) Press  to continue to the Parameter Name mmode1. The display will flash between mmode1 and the default value of latch. When the display shows latch, press .
- 3) Use the arrow keys to select the correct mode. Press  when the correct mode is selected to accept value, and to the next parameter, Output 1 Bindings. Other choices may appear, depending on which Output 1 Mode is selected. See Appendix B for which options correspond to which parameters.
- 4) Press  until oput 2 setup is displayed to make similar selections for Output 2 Mode.
- 5) When all selections are entered and accepted into counter memory, counter will proceed to next menu category, Set Point Setup.

#### 4.5 Set Point Parameters (Set Point Setup)

The S661 has four set point parameters and an Offset Value.





SP1 and SP2 are used only with Output 1, and SP3 and SP4 are used only with Output 2.

The SP1 and SP3 parameters are used as Latched or Timed “trigger” values. When a Boundary Output is selected, SP1 and SP3 become the low boundary value.





The SP2 and SP4 parameters are used as high boundary value or ‘turn-off’ values when used with other alarm types (i.e. latched until SP4).

The values for all set points are -99999 to 999999. The decimal point will appear according to the current decimal point setting.

## Set Point Parameters

- 1) To set the Set Point parameters, enter the Programming Mode, and press  until the setpnt setup menu category is reached.
- 2) Press  to continue to the Parameter Name sp 1. The display will flash between sp 1 and the default value of 000010. When the display shows 000010, press .
- 3) Use the arrow keys to enter the correct value of the flashing digit. Use the  key to advance to the next digit. Press  when the correct set point is selected to accept value and proceed to the next parameter, SP 2.
- 4) Repeat these steps for SP 2, SP 3, and SP 4. The counter will proceed to the next menu category, Reset Setup.

## 4.6 Miscellaneous Controls

- 1) To access the Miscellaneous Controls, enter the Programming Mode, and press  until the reset setup menu category is reached.
- 2) Press  to continue to the Parameter Name rstbtn. The display will flash between rstbtn and the default value of enable. When the display shows enable, press .
- 3) Use the arrow keys to select either Enable or Disable. Press  when the correct mode is selected to accept selection.
- 4) The display will now show end. If you are finished programming the S661, press . If not, press the arrow keys to back up to the necessary parameter.

r St bt n <b>(Reset Button)</b>	The Reset button Inhibit feature disables the front panel reset button. This can be used to prevent accidental resets. The external (rear panel) hardware reset input is not affected by this setting.
------------------------------------	--

## Appendix A: Technical Specifications

### A.1 Functional Specifications

<b>Count modes supported</b>	Count/Direction, Add-Add, Add-Subtract, Subtract-Subtract, Quadrature, Batch, and Rate
<b>Count Inputs</b>	2: Channel A (Primary) and Channel B (Secondary/Dir control)
<b>Miscellaneous inputs</b>	2: Reset (Alarm Reset) and User (Display Hold)
<b>Maximum count rate</b>	30 KHz (Standard and Quadrature X1 modes) 7.5 KHz (Quadrature X4 mode)
<b>Min pulse width</b>	2 uS (Standard mode)
<b>Rate modes supported</b>	See Table 8
<b>Frequency accuracy (instantaneous)</b>	$> \pm 0.02\%$ of reading
<b>Frequency vs temperature</b>	+ 0.0001% of reading per °C
<b>Frequency vs time (aging)</b>	$\pm 0.002\%$ of reading per year
<b>Display Digits</b>	6-digit, 7-segment with leading zero blanking
<b>Display Decimal Point</b>	User-programmable
<b>Display LEDs</b>	Red 0.56" (14.2mm), high efficiency
<b>Display Range</b>	- 99,999 to + 999,999 (Independent of decimal position)
<b>Output channels</b>	2, with front panel indicator for each
<b>Output modes</b>	Disabled, Timed, Latching and Boundary
<b>Delay times</b>	0.01 to 599.99 sec tol: -2.5 ms/+15ms
<b>Output Response time</b>	Within 10 ms of reading update (see rate modes)
<b>Multi-tasking Operation</b>	Count and output control maintained while in Programming mode.

## A.2 Electrical, Environmental and Mechanical Specifications

<b>Power Requirements</b>	AC Supply: 120 or 240 VAC, $\pm 10\%$
<b>Power Consumption</b>	3VA
<b>Reset Input Signal</b>	Active Low: 0.2 VDC = active
<b>Storage Temperature</b>	-10 to 60°C
<b>Operating Temperature</b>	0 to 40°C
<b>Relative Humidity</b>	0 to 80% for temperatures less than 32°C, decreasing linearly to 50% at 40°C. (Non-condensing)
<b>Bezel</b>	3.93" x 2.04" x 0.52" (99.8 x 51.8 x 13.3mm)
<b>Panel Cutout</b>	3.62" x 1.77" (92 x 45 mm) 1/8 DIN
<b>Case Depth</b>	3.24" (82mm)
<b>Weight</b>	9.0 oz. (255.1g)

### Standard input module

<b>Input Channels</b>	A, B and User
<b>Count edge</b>	High to low transition (A and B channels)
<b>Input Sources</b>	Switch contact, CMOS or TTL logics, PNP or NPN devices
<b>Input Impedance</b>	Sinking: 10K, 5% Res. Pull-up to (9.0 - 16 VDC) $\pm 10\%$ Sourcing: 5.1K, 5% Res. Pull-down to common

### Input Thresholds

<b>A &amp; B channels</b>	Low Bias mode: VLT = 1.6V $\pm 10\%$ VUT = 3.6V $\pm 10\%$ High Bias mode: VLT = 5.0V $\pm 10\%$ VUT = 7.0V $\pm 10\%$
<b>User Channel</b>	VLT = 0.2V (min) VUT = 3.0V (max)
<b>Low pass filter</b>	Frequency < 200Hz (0 to 10V input square wave at 50% duty cycle)
<b>Max voltage</b>	A, B and User channels 30VDC maximum sustained



## Quadrature input module

<b>Input Channels</b>	A, B and User
<b>Input Inversion</b>	User-selectable input polarity. A and B channel polarity selective in standard mode only.
<b>Operation modes</b>	Standard, Quadrature X1 and Quadrature X4
<b>Input Sources</b>	Switch contact, CMOS or TTL logics, PNP or NPN devices quadrature (single-ended) encoders
<b>Input Impedance</b>	Sinking: 10K, 5% Res. Pull-up to (9.0 - 16 VDC) $\pm 10\%$ Sourcing: 5.1K, 5% Res. Pull-down to common

### Input Thresholds

<b>A &amp; B channels</b>	Low Bias mode: VLT = 1.6V $\pm 10\%$ VUT = 3.6V $\pm 10\%$ High Bias mode: VLT = 5.0V $\pm 10\%$ VUT = 7.0V $\pm 10\%$
<b>User Channel</b>	VLT = 0.9V (min) VUT = 3.15V (max)
<b>Low pass filter</b>	Frequency < 200Hz (0 to 10V input square wave at 50% duty cycle)
<b>Max voltage</b>	A, B and User channels 30VDC maximum sustained

## Single / Dual Relay Modules

<b>Contact Rating</b>	5 Amps 250 VAC
<b>Mechanical Life</b>	1,000,000 cycles

## Isolated 12V Excitation Module

<b>Excitation Output</b>	100 mA at 12 VDC $\pm 5\%$
<b>Excitation Isolation</b>	1500 V

## Appendix B: Programming Quick Reference

If you are unfamiliar with navigating menus in the S661 see section 3. Each parameter is listed in the order of appearance in the menu system. Refer to the paragraph indicated in the Tech Note column for technical details on a particular parameter.

Tip: Photocopy these pages to mark settings on.

Menu Category	Parameter Name	Choices / Format	Description	Tech Note
	PASS	000	<b>Password Entry and Verification</b>	4.1
	ACCESS<—	—>dEn, Ed	<b>Password Fail</b> <i>Appears if incorrect password entered</i>	4.1
	CHPASS	000*	<b>Password Change</b> <i>Appears if correct password entered</i> 000 = Password protection disabled 001-099 = Secures all parameters 100-999 = Enables <b>SPs/ResPos</b> access in display mode	4.1

\* = factory default settings

Menu Category	Parameter Name	Choices / Format	Description	Tech Note
INPUT SETUP	A CHAN	uP* doBn qUAd r qUAd	<b>Chan A Mode</b> Select count mode of A channel.	4.2
	B CHAN	di r* uP doBn	<b>Chan B Mode</b> Select count mode for B channel. Note: If A channel set to Quad or Rquad, this item is not accessible.	4.2
RATE SETUP	MODE	nnSEC* SEC nn n Hr	<b>Rate Mode</b> Defines the prescaling and sampling interval for frequency computation	4.3
	SCALE	00.0000*	<b>Scale</b> Set Display Value (Rate) scaling multiplier. <i>Values: -9.9999 to 9.9999</i>	4.3

\* = factory default settings

Menu Category	Parameter Name	Choices / Format	Description	Tech Note
	dP	000000* 000000. 00000.0 0000.00 000.000 00.0000 0.00000	<b>DP</b> Display Value 2 (Rate) Decimal Point location. Affects appearance of <b>Offset</b> and <b>Set Point</b> parameters.	4.3
	oFFSEt	000000*	<b>Offset</b> Set Display Value 2 (Rate) scaling offset. <i>Values:</i> -99999 to 999999. A decimal point will appear according to the user-programmed <b>DP</b> position.	4.3
oPut 1 SEtUP	mModE 1	d, sAbL t, nNEd LAtCH* bound	<b>Output 1 Mode</b> Set the mode of operation for Output 1. Can be disabled, timed, latched or boundary mode.	4.4

\* = factory default settings

Menu Category	Parameter Name	Choices / Format	Description	Tech Note
	SP1=Lo←	→SP2=Hi	<b>Output 1 Bindings</b> Reminder message indicates which and how the set points are used for comparison.	4.4
	dELAY 1	0 10.00*	<b>Delay 1</b> Output 1 delay time. <i>Appears only if Output 1 mode set to timed.</i>	4.4
oPut 2 SEtUP	mModE2	di, SAbl ti, nNEd LAteCH* bound	<b>Output 2 Mode</b> Set the mode of operation for Output 2. Can be disabled, timed, latched or boundary mode.	4.4
	SP3=Lo←	→SP4=Hi	<b>Output 2 Bindings</b> Reminder message indicates which and how the set points are used for comparison.	4.4

\* = factory default settings

Menu Category	Parameter Name	Choices / Format	Description	Tech Note
	dELAY 2	0 10.00*	<b>Delay 2</b> Output 2 delay time. <i>Appears only if Output 2 mode set to timed.</i>	4.4
SEtPnt SEtUP	SP 1	0000 10*	<b>SP1</b> Set point #1 Low. <i>Values:</i> -99999 to 999999. Decimal point will appear according to the current <b>DP</b> setting.	4.5
	SP2	000020 *	<b>SP2</b> Set point #1 High. <i>Values:</i> -99999 to 999999. Decimal point will appear according to the current <b>DP</b> setting.	4.5

\* = factory default settings

Menu Category	Parameter Name	Choices / Format	Description	Tech Note
	SP3	000030*	<b>SP3</b> Set point #2 Low. <i>Values:</i> -99999 to 999999. Decimal point will appear according to the current <b>DP</b> setting.	4.5
	SP4	000040*	<b>SP4</b> Set point #2 High. <i>Values:</i> -99999 to 999999. Decimal point will appear according to the current <b>DP</b> setting.	4.5
rESEt SEtUP	rStbLn	EnAbLE* d, SAbl	<b>Reset Button</b> Enable or disable front panel reset button.	4.6
End			<b>Exit Programming Menu</b>	

\* = factory default settings