

R9910SD

# REED INSTRUMENTS

## Data Logging Air Quality Meter



## Instruction Manual



# Table of Contents

Introduction .....	3
Product Quality.....	4
Safety .....	4
Features .....	4
Included .....	4
Specifications.....	5-6
Instrument Description .....	7
Display Description .....	8
Operating Instructions .....	9-11
<i>Power ON/OFF</i> .....	9
<i>Selecting Measurement Modes</i> .....	9
<i>Humidity/Temperature Mode</i> .....	10
<i>Dew Point Measurement Mode</i> .....	10
<i>Wet Bulb Temperature Measurement Mode</i> .....	10
<i>CO/Temperature Measurement Mode</i> .....	10
<i>O<sub>2</sub>/Temperature Measurement Mode</i> .....	10
<i>CO<sub>2</sub>/Temperature Measurement Mode</i> .....	11
<i>Data Hold</i> .....	11
<i>Recording Maximum and Minimum Readings</i> .....	11
<i>Backlight</i> .....	11
Setup Mode .....	12-16
<i>Formatting the SD Card (Sd F)</i> .....	12-13
<i>Setting the Time and Date (dAtE)</i> .....	13
<i>Setting the Data Logging Sampling Rate (SP-t)</i> .....	13
<i>Enabling/Disabling Auto Power Off (PoFF)</i> .....	14
<i>Enabling/Disabling the Beeper (bEEP)</i> .....	14
<i>Setting Data Decimal Format (dEC)</i> .....	14
<i>Selecting the Temperature Unit of Measure (t-CF)</i> .....	15

continued...

Setting Alarm Value for CO <sub>2</sub> .....	15
Advanced Setup Mode (CO <sub>2</sub> mode only) .....	15
Setting CO <sub>2</sub> Height Compensation Value (m) .....	15
Setting CO <sub>2</sub> Height Compensation Value (ft) .....	15
ESC .....	15
Verify Set Time and Date .....	16
Verify Sampling Rate .....	16
Data Logging .....	16-22
Data Recording Modes .....	16
Manual Data Logging Mode .....	16-17
Automatic Data Logging Mode .....	17
Transferring Data from the SD Memory Card to a Computer.....	17-21
Calibration of O <sub>2</sub> Sensor.....	21
Data Stream Output .....	22
3.5mm Terminal to RS-232 Serial Connection .....	22
System Reset .....	23
Battery Replacement .....	23
Applications .....	23
Accessories and Replacement Parts .....	24
Frequently Asked Questions (FAQ's) .....	24-25
Product Care .....	25
Product Warranty .....	26
Product Disposal and Recycling .....	26
Product Support .....	26

## Introduction

Thank you for purchasing your REED R9910SD Data Logging Air Quality Meter. Please read the following instructions carefully before using your instrument. By following the steps outlined in this manual your meter will provide years of reliable service.

## Product Quality

This product has been manufactured in an ISO9001 facility and has been calibrated during the manufacturing process to meet the stated product specifications. If a certificate of calibration is required please contact the nearest authorized REED distributor or authorized Service Center. Please note an additional fee for this service will apply.

## Safety

Never attempt to repair or modify your instrument. Dismantling your product, other than for the purpose of replacing batteries, may cause damage that will not be covered under the manufacturer's warranty. Servicing should only be provided by an authorized service center.

## Features

- Measures oxygen (O<sub>2</sub>), carbon dioxide (CO<sub>2</sub>), carbon monoxide (CO), temperature and humidity
- Records up to 3 readings simultaneously
- User adjustable audible alarms
- User selectable unit of measure (°F or °C)
- Data hold and Max/Min functions
- Real-time datalogger with integrated SD memory card
- User selectable sampling rate from 2 seconds to 8 hours
- Easy-to-read backlit LCD display
- Tripod mount for long-term monitoring
- Low battery indicator and auto shut off

## Included

- Humidity Probe
- Carbon Monoxide Probe
- Carbon Dioxide Probe
- Oxygen Probe
- Hard Carrying Case
- Batteries

# Specifications

## Temperature

Measuring Ranges:	32 to 122.0°F (0 to 50.0°C) Dew Point: -13.5 to 120.1°F (-25.3 to 48.9°C) Wet Bulb: -6.9 to 122.0°F (-21.6 to 50°C)
Accuracy	±1.5°F (±0.8°C)
Resolution	0.1°F/°C

## Humidity

Measuring Range:	5 to 95%RH
Accuracy:	>70%RH: ±(3% rdg + 1%RH) <70%RH: ±3%RH
Resolution:	0.1%RH

## CO<sub>2</sub>

Measuring Range:	0 to 4,000ppm
Accuracy:	< 999ppm: ±40ppm >1,000ppm ≤3,000ppm: ±5% rdg >3,000ppm: ±250ppm
Resolution:	1ppm

## CO

Measuring Range:	0 to 1,000ppm
Accuracy:	±(5% + 2ppm)
Resolution:	1ppm

## O<sub>2</sub>

Measuring Range:	0 to 30% O <sub>2</sub>
Accuracy:	±(1% + 0.2% O <sub>2</sub> )
Resolution:	0.10%

## General Specifications

Alarm Threshold:	<18% O <sub>2</sub>
Response Time:	1 second
Display:	4-digit dual LCD

*continued...*

**REED**

Backlit Display:	Yes
Data Hold:	Yes
Min:	Yes
Max:	Yes
Datalogging Capabilities:	Yes
Real-Time Clock and Date Stamp:	Yes
Selectable Sampling Rate:	Yes (1 second to 8 hours, 59 minutes and 59 seconds)
External Memory:	Yes, expandable up to 16GB with SD card (optional)
Auto Shut-off:	Yes (after 10 minutes/off)
Kick Stand:	Yes
Tripod Mountable:	Yes
Low Battery Indicator:	Yes
Power Supply:	6 x AA batteries or AC Adapter (optional)
Data Output:	Yes (RS-232)
Product Certifications:	CE
Operating Temperature:	0 to 122°F (0 to 50°C)
Storage Temperature:	14 to 140°F (-10 to 60°C)
Operating Humidity Range:	10 to 85%
Dimensions:	Instrument: 7.0 x 2.7 x 1.8" (177 x 68 x 45mm) Humidity Probe Length: 7.8" (197mm) CO Probe Length: 5.9" (150mm) CO <sub>2</sub> Probe Length: 7.5" (190mm) O <sub>2</sub> Probe Length: 5.9" (150mm)
Weight:	0.8lbs (350g)

# Instrument Description

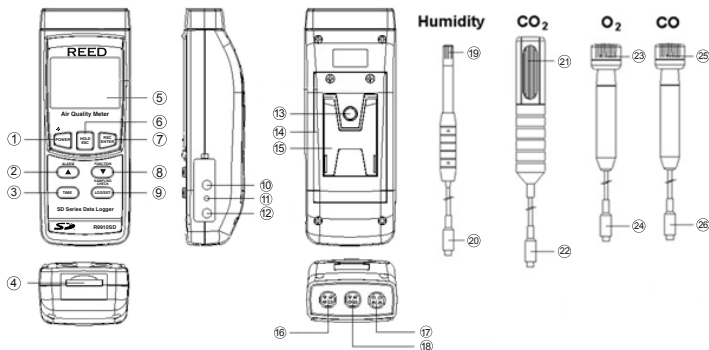

- |                                  |                                   |
|----------------------------------|-----------------------------------|
| 1. Power/Backlight Button        | 14. Battery Cover                 |
| 2. Up/Alarm Button               | 15. Kickstand                     |
| 3. Time Button                   | 16. Humidity Input Jack           |
| 4. SD Card Slot                  | 17. O <sub>2</sub> /CO Input Jack |
| 5. LCD Display                   | 18. CO <sub>2</sub> Input Jacket  |
| 6. Hold/ESC Button               | 19. Humidity Sensing Head         |
| 7. Rec/Enter Button              | 20. Humidity Probe Plug           |
| 8. Down/Function Button          | 21. CO <sub>2</sub> Sensing Head  |
| 9. Log/Set/Sampling Check Button | 22. CO <sub>2</sub> Probe Plug    |
| 10. RS-232 Output Jack           | 23. O <sub>2</sub> Sensing Head   |
| 11. Reset Pin                    | 24. O <sub>2</sub> Probe Plug     |
| 12. Power Adapter Input Jack     | 25. CO Sensing Head               |
| 13. Tripod Mounting Screw        | 26. CO Probe Plug                 |

## Display Description

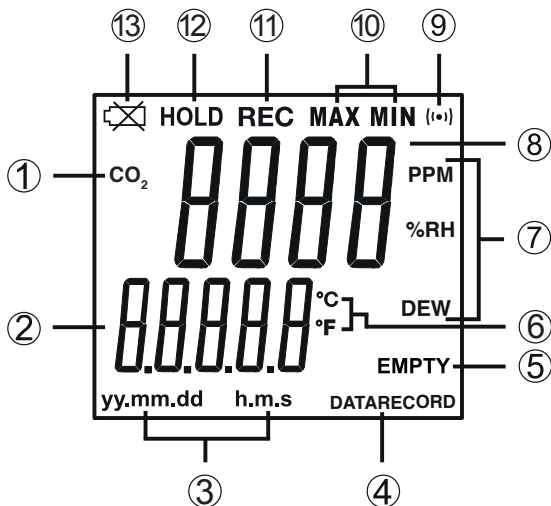

- |   |                                    |
|---|------------------------------------|
| 1. CO/CO <sub>2</sub> /O <sub>2</sub> Mode Indicators | 8. Measurement Reading Indicator   |
| 2. Date & Time Values/Temperature Measurement Reading | 9. CO <sub>2</sub> Sensor Signal   |
| 3. Date/Time Stamp                                    | 10. Maximum and Minimum Indicators |
| 4. Data Logging Status Indicator                      | 11. Record Mode Indicator          |
| 5. SD Card Status Indicator                           | 12. Data Hold Indicator            |
| 6. Temperature Unit of Measure                        | 13. Low Battery Indicator          |
| 7. CO/Humidity/Dew Point Units of Measure             |                                    |



# Operating Instructions

## *Power ON/OFF*

Turn the meter on by pressing the **POWER** button. To turn the meter off, press and hold the **POWER** button for 2 seconds.

**Note:** This meter can be powered by either six (6) "AA" batteries or AC adapter (sold separately).

## *Selecting Measurement Modes*

The R9910SD has 6 measurement modes:

- Humidity/Temperature
- Dew Point Temperature
- Wet Bulb Temperature
- CO/Temperature
- O<sub>2</sub>/Temperature
- CO<sub>2</sub>/Temperature

**Note:** Up to three probes can be plugged in at the same time: the Humidity, CO<sub>2</sub>, and either the O<sub>2</sub> or the CO Probe. The meter will data log all three values, however, only one value can be displayed at a time on the LCD screen.

1. Connect the Humidity, CO<sub>2</sub>, and either the O<sub>2</sub> or CO Probe into the meter.
2. When the meter is on, press the FUNCTION button to scroll through the measuring modes. The display will flash "rH" (for Humidity/Temperature measurement), "dP" (for Dew Point measurement), "\_Et" (for Wet Bulb measurement), "CO<sub>2</sub>" (for CO<sub>2</sub>/temperature measurement), "CO" (for CO/temperature measurement) and "O<sub>2</sub>" (for O<sub>2</sub>/temperature measurement).
3. Release the FUNCTION button to confirm selection.

*continued...*

## Humidity/Temperature Measurement Mode

1. Select the "rH" function (see *Selecting Measurement Modes* for details).
2. The top part of the display will leave the humidity value, and the lower part of the display will show the temperature value as shown.



## Dew Point Measurement Mode

1. Select the "dP" function (see *Selecting Measurement Modes* for details).
2. The top part of the display will indicate the Dew Point value while the lower part of the display will indicate "DEW" as shown.



## Wet Bulb Temperature Measurement Mode

1. Select the "\_Et" measurement mode (see *Selecting Measurement Modes* for details).
2. The LCD display will indicate the wet bulb value as shown.



**Note:** The wet bulb value is automatically calculated from the humidity/temperature measurement.

## CO/Temperature Measurement Mode

1. Select the "CO" function (see *Selecting Measurement Modes* for details).
2. The top part of the display will indicate the CO value in PPM, and the lower part of the display will show the temperature value as shown.

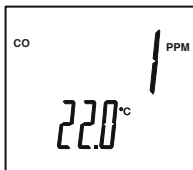

## O<sub>2</sub>/Temperature Measurement Mode

1. Select the "O<sub>2</sub>" function (see *Selecting Measurement Modes* for details).
2. The top part of the display will indicate the O<sub>2</sub>% value, and the lower part of the display will show the temperature value as shown.

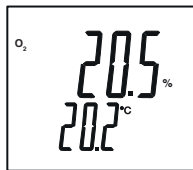

continued...

## CO<sub>2</sub>/Temperature Measurement Mode

1. Select the "CO<sub>2</sub>" function (see *Selecting Measurement Modes* for details).
2. The top part of the display will indicate the CO<sub>2</sub> value in PPM, and the lower part of the display will show the temperature value as shown.

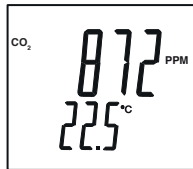

## Data Hold

1. While taking a measurement, press the **HOLD** button to freeze the current readings on the display.
2. While in this mode a HOLD symbol will appear.
3. Press the **HOLD** button again to resume normal operation.

**Note:** When the Data Hold feature is active all buttons except the **POWER** button are disabled.

## Recording Maximum and Minimum Readings

1. Press the **REC** button to enter recording mode as indicated by "RECORD" on the LCD. The meter will now begin recording maximum and minimum readings.
2. While in recording mode;
  - A) Press the **REC** button once and the maximum value will appear on the display as indicated by "RECORD MAX".
  - B) Press the **REC** button again and the minimum value will appear on the display as indicated by "RECORD MIN".
  - C) To exit recording mode and resume normal operation, press and hold the **REC** button for two seconds.

When in recording mode the **POWER** button is disabled and the meter cannot be turned off.

## Backlight

After powering the meter ON, the LCD Backlight will turn on automatically. Press the BACKLIGHT button to turn the LCD Backlight on or off.

## Setup Mode

1. Press and hold the **SET** button for 2 seconds to enter Setup Mode.
2. Press the **SET** button continuously to scroll through the following parameters.

Parameter	Description
Sd F	Format the SD memory card
dAtE	Set the time and date
SP-t	Set the data logging sampling rate
PoFF	Enable or disable the auto-power off function
bEEP	Turn the beeper on or off
dEC	Set the decimal format (USA (20.00) or European (20,00))
t-CF	Select the temperature unit of measure (°C or °F)
AL	Set alarm value
Hlgh	Set CO <sub>2</sub> height compensation value in meters (CO <sub>2</sub> mode only)
Hlghf	Set CO <sub>2</sub> height compensation value in feet (CO <sub>2</sub> mode only)
ESC	Exit Setup mode

3. Once the appropriate parameter has been selected, follow the instructions below.

**Note:** The meter will automatically exit out of the mode if no key is pressed within 7 seconds.

### *Formatting the SD Card (Sd F)*

Follow steps 1 through 4 when "Sd F" appears on the LCD.

1. Press the ▲ and ▼ buttons to select "YES" to format the card. Select "NO" to abort.
2. Press the **ENTER** button to confirm selection.
3. Press the **ENTER** button again to re-confirm.

*continued...*

4. The meter will format the SD card and automatically return to the Setup menu when formatting is complete.

**Note:** At any time, you can press the **ESC** button to exit the Setup mode and resume normal operation. It is recommended that new SD cards should be formatted prior to first use. If the formatting process fails or if no card is inserted, the meter will display "CARd Empty".

### ***Setting the Time and Date (dAtE)***

Follow steps 1 through 4 when "dAtE" appears on the LCD.

1. Press the ▲ and ▼ buttons to adjust the year as indicated by "YY."
2. Press the **ENTER** button to confirm selection.
3. Repeat steps 1 and 2 for month, day, hour, minute and seconds as indicated by (mm/dd/h/m/s).
4. Press the **SET** button to save the time stamp and skip to next parameter.

**Note:** At any time, you can press the **ESC** button to exit the Setup mode and resume normal operation. The internal clock will keep accurate time when the meter is powered off. When new batteries are installed the clock will have to be reset.

### ***Setting the Data Logging Sampling Rate (SP-t)***

Follow steps 1 through 4 when "SP-t" appears on the LCD.

1. The sampling rate can be set from "0" seconds (manual log mode only) up to 8 hours, 59 minutes and 59 seconds.
2. Press the ▲ and ▼ buttons to adjust the required sampling rate by hours, minutes or seconds as indicated by (h/m/s).
3. Press the **ENTER** button to confirm each selection.
4. Press the **SET** button to save the selected sampling rate and skip to next parameter.

**Note:** At any time, you can press the **ESC** button to exit the Setup mode and resume normal operation.

*continued...*

## ***Enabling/Disabling Auto Power Off (PoFF)***

Follow steps 1 through 3 when "PoFF" appears on the LCD.

1. Press the ▲ and ▼ buttons to select between YES (enabled) or NO (disabled). With the Auto Power OFF feature enabled, the meter will automatically switch OFF after 10 minutes of inactivity to preserve battery life.
2. Press the **ENTER** button to confirm selection.
3. Press the **SET** button to save and skip to the next parameter.

**Note:** At any time, you can press the **ESC** button to exit the Setup mode and resume normal operation.

## ***Enabling/Disabling the Beeper (bEEP)***

Follow steps 1 through 3 when "bEEP" appears on the LCD.

1. Press the ▲ and ▼ buttons to select between ON (enabled) or OFF (disabled).
2. Press the **ENTER** button to confirm selection.
3. Press the **SET** button to save and skip to the next parameter.

**Note:** At any time, you can press the **ESC** button to exit the Setup mode and resume normal operation.

## ***Setting Data Decimal Format (dEC)***

Numeric formats vary in different countries. By default the meter is set to bASIC mode where a decimal point is used to separate units, (i.e. 20.00). The European format uses a comma (i.e. 20,00) to separate units. To change this setting, follow steps 1 through 3 when "dEC" appears on the LCD.

1. Press the ▲ and ▼ buttons to select between bASIC and Euro.
2. Press the **ENTER** button to confirm selection.
3. Press the **SET** button to save and skip to the next parameter.

**Note:** At any time, you can press the **ESC** button to exit the Setup mode and resume normal operation.

*continued...*

## ***Selecting the Temperature Unit of Measure (t-CF)***

Follow steps 1 through 3 when "t-CF" appears on the LCD.

1. Press the ▲ and ▼ buttons to select between °C and °F.
2. Press the **ENTER** button to confirm selection.
3. Press the **SET** button to save and skip to the next parameter.

**Note:** At any time, you can press the **ESC** button to exit the Setup mode and resume normal operation.

## ***Setting Alarm Value for CO<sub>2</sub>***

Follow steps 1 through 3 when "AL" appears on the LCD.

1. Press the ▲ and ▼ buttons to adjust the CO<sub>2</sub> alarm value.
2. Press the **ENTER** button to confirm selection.
3. Press the **SET** button to save and skip to the next parameter.

**Note:** At any time, you can press the **ESC** button to exit the Setup mode and resume normal operation.

## ***Advanced Setup Mode (CO<sub>2</sub> mode only)***

### ***Setting CO<sub>2</sub> Height Compensation Value (m)***

Follow steps 1 through 3 when "Hlgh" appears on the LCD.

1. Press the ▲ and ▼ buttons to adjust the CO<sub>2</sub> height compensation value ranging from 0 to 8900 meters.
2. Press the **ENTER** button to confirm selection.
3. Press the **SET** button to save and skip to the next parameter.

### ***Setting CO<sub>2</sub> Height Compensation Value (ft)***

Follow steps 1 through 3 when "HlghF" appears on the LCD.

1. Press the ▲ and ▼ buttons to adjust the CO<sub>2</sub> height compensation value ranging from 0 to 2930 feet.
2. Press the **ENTER** button to confirm selection.
3. Press the **SET** button to save and skip to the next parameter.

## ***ESC***

Press the **SET** button when "ESC" appears on the LCD to exit the Setup mode and resume normal operation.

*continued...*

## Verify Set Time and Date

During normal operation, press the **TIME** button once to display the hour, minute, seconds. Press the **TIME** button to display the year, month, and day.

## Verify Sampling Rate

During normal operation, press the Sampling Check button to view the selected sampling rate.

## Data Logging

### Data Recording Modes

**Manual Data Logging:** Press the **LOG** button to manually log up to 99 readings on a SD memory card (see *Manual Data Logging Mode* for full setup instructions).

**Automatic Data Logging:** Setup the meter parameters in order to automatically log data on a SD memory card. The number of data points is limited by the size of the memory card.

**Note:** It is recommended to use a class 4 SDHC memory card between 1 and 16Gb. Insert the SD memory card in the slot at the bottom of the meter. The card must be inserted with the label side facing the rear of the meter.

### Manual Data Logging Mode

In manual mode, the "LOG" button is pressed to manually log a reading on the inserted SD card at any time. In order to setup the meter for manual data logging, follow steps 1 through 7 below.

1. Set the data logging sampling rate to "0" seconds (see "*Setting the Data Logging Sampling Rate*" for details).
2. Press the **REC** button and "RECORD" will appear on the LCD.
3. Press the **LOG** button to enter manual data logging function as indicated by "DATARECORD".
4. The meter will also display P-X (X = memory position number between 1 and 99)
5. Press the ▲ and ▼ buttons to select one of the 99 data memory positions in which to record.

*continued...*



6. Press the **LOG** button again to save a reading to memory. Both the memory position number and "DATARECORD" will flash each time a data point is stored.

**Note:** If a card is not inserted or the card is defective, the meter will flash "EMPTY". In this case, power the meter OFF and try again with another SD memory card or verify that the card is correctly inserted.

7. To exit manual data logging mode, press and hold the **REC** button 2 seconds to resume normal operation.

### ***Automatic Data Logging Mode***

In automatic mode the desired data logging sampling rate can be set between 1 second to 8 hours, 59 minutes and 59 seconds prior to recording. In order to setup the meter for automatic data logging, follow steps 1 through 5 below.

1. Press the **REC** button and "RECORD" will appear on the LCD.
2. Press the **LOG** button to enter automatic data logging function as indicated by "DATARECORD".

**Note:** If a card is not inserted or the card is defective, the meter will flash "EMPTY" above "DATARECORD". In this case, power the meter OFF and try again with another SD memory card or verify that the card is correctly inserted.

3. The "DATARECORD" icon will appear on the LCD and will flash every time a reading is stored.
4. To pause the data logging session press the **LOG** button and "DATARECORD" will stop flashing. To resume press the **LOG** button again.
5. To end the current data logging session press and hold the **REC** button for 2 seconds.

### ***Transferring Data from the SD Memory Card to a Computer***

1. While the meter is powered Off remove the SD memory card from the SD card slot.
2. Insert the SD memory card into the computer.

*continued...*

3. Open the file(s) with Excel. See sample below for a Humidity/Temperature measurement:

Position	Date	Time	Ch1_RH	RH_Unit	Ch1_rhT	rhT_unit
1	19-07-10	10:14:13	25	%RH	21.8	Degree_C
2	19-07-10	10:14:15	30	%RH	25	Degree_C
3	19-07-10	10:14:17	35	%RH	30	Degree_C
4	19-07-10	10:14:19	40	%RH	35	Degree_C
5	19-07-10	10:14:21	45	%RH	25	Degree_C
6	19-07-10	10:14:23	35	%RH	20	Degree_C
7	19-07-10	10:14:26	45	%RH	35	Degree_C
8	19-07-10	10:14:28	30	%RH	21.8	Degree_C
9	19-07-10	10:14:30	50	%RH	21.9	Degree_C
10	19-07-10	10:14:32	25	%RH	35	Degree_C
11	19-07-10	10:14:34	30	%RH	21.9	Degree_C
12	19-07-10	10:14:36	20	%RH	21.9	Degree_C

The raw data can be used to create a graph in Excel. See sample below:

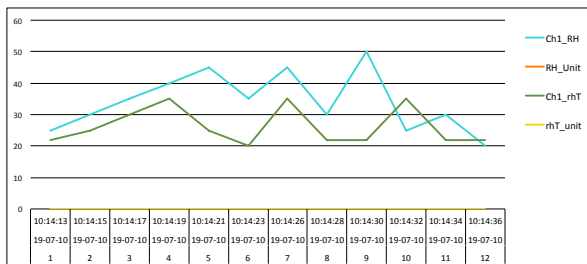

See sample below for a Dew Point Temperature measurement:

Position	Date	Time	Ch1_DEW	dew_unit
1	19-07-10	10:14:13	-2	DEW C
2	19-07-10	10:14:15	-2	DEW C
3	19-07-10	10:14:17	-3	DEW C
4	19-07-10	10:14:19	-2	DEW C
5	19-07-10	10:14:21	-5	DEW C
6	19-07-10	10:14:23	-2	DEW C
7	19-07-10	10:14:26	-2	DEW C
8	19-07-10	10:14:28	-3	DEW C
9	19-07-10	10:14:30	-2	DEW C
10	19-07-10	10:14:32	-2	DEW C
11	19-07-10	10:14:34	-5	DEW C
12	19-07-10	10:14:36	-2	DEW C

continued...

The raw data can be used to create a graph in Excel. See sample below:

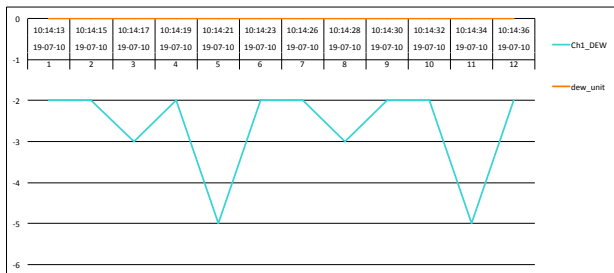

See sample below for a Wet Bulb Temperature measurement:

Position	Date	Time	Ch1_wet	wet_unit
1	19-07-10	10:14:13	15	WET C
2	19-07-10	10:14:15	20	WET C
3	19-07-10	10:14:17	2	WET C
4	19-07-10	10:14:19	15	WET C
5	19-07-10	10:14:21	20	WET C
6	19-07-10	10:14:23	25	WET C
7	19-07-10	10:14:26	2	WET C
8	19-07-10	10:14:28	20	WET C
9	19-07-10	10:14:30	25	WET C
10	19-07-10	10:14:32	30	WET C
11	19-07-10	10:14:34	15	WET C
12	19-07-10	10:14:36	10.4	WET C

The raw data can be used to create a graph in Excel. See sample below:

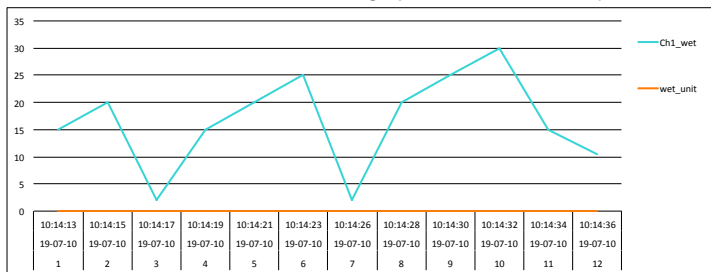

continued...

See sample below for a CO<sub>2</sub>/Temperature measurement:

Position	Date	Time	Ch2_CO <sub>2</sub>	CO <sub>2</sub> _unit
1	19-07-10	10:14:13	849	CO <sub>2</sub> PPM
2	19-07-10	10:14:15	750	CO <sub>2</sub> PPM
3	19-07-10	10:14:17	600	CO <sub>2</sub> PPM
4	19-07-10	10:14:19	800	CO <sub>2</sub> PPM
5	19-07-10	10:14:21	650	CO <sub>2</sub> PPM
6	19-07-10	10:14:23	700	CO <sub>2</sub> PPM
7	19-07-10	10:14:26	850	CO <sub>2</sub> PPM
8	19-07-10	10:14:28	845	CO <sub>2</sub> PPM
9	19-07-10	10:14:30	500	CO <sub>2</sub> PPM
10	19-07-10	10:14:32	845	CO <sub>2</sub> PPM
11	19-07-10	10:14:34	845	CO <sub>2</sub> PPM
12	19-07-10	10:14:36	845	CO <sub>2</sub> PPM

The raw data can be used to create a graph in Excel. See sample below:

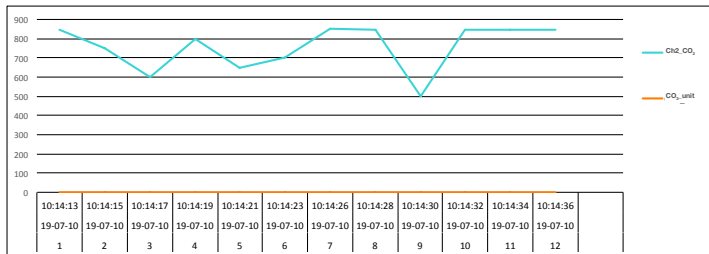

See sample below for a CO/Temperature measurement:

Position	Date	Time	Ch3_CO	Co_unit	Ch3_CoT	CoT_unit
1	19-07-10	10:14:13	2	CO PPM	21.1	Degree_C
2	19-07-10	10:14:15	5	CO PPM	22	Degree_C
3	19-07-10	10:14:17	10	CO PPM	23	Degree_C
4	19-07-10	10:14:19	15	CO PPM	25	Degree_C
5	19-07-10	10:14:21	20	CO PPM	25	Degree_C
6	19-07-10	10:14:23	10	CO PPM	23	Degree_C
7	19-07-10	10:14:26	15	CO PPM	25	Degree_C
8	19-07-10	10:14:28	15	CO PPM	23	Degree_C
9	19-07-10	10:14:30	10	CO PPM	25	Degree_C
10	19-07-10	10:14:32	25	CO PPM	21.1	Degree_C
11	19-07-10	10:14:34	10	CO PPM	21.2	Degree_C
12	19-07-10	10:14:36	5	CO PPM	21.2	Degree_C

continued...

The raw data can be used to create a graph in Excel. See sample below:

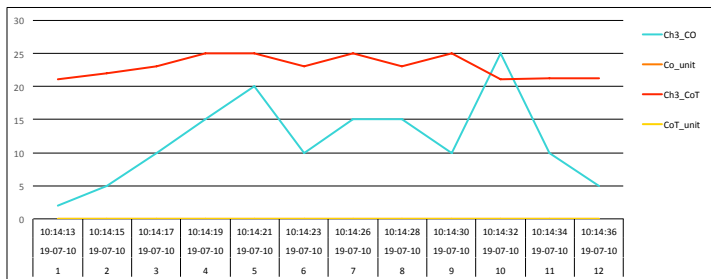

### Calibration of O<sub>2</sub> Sensor

It is not necessary to calibrate the Humidity, CO or CO<sub>2</sub> probes before use as they are calibrated during production. In reference to the O<sub>2</sub> probe, it is recommended to perform a calibration of the O<sub>2</sub> sensor prior to first use and when not in use for extended periods. Follow steps 1 through 6 if the O<sub>2</sub> appears to be providing false readings.

1. Place the probe in the air and wait a moment until the displayed readings become stable.
2. Press both the **HOLD** and **REC** buttons simultaneously.
3. Once the display indicates "CAL", release both buttons and the display will now "O<sub>2</sub>".
4. Press the **ENTER** button and the display should indicate "20.9".

**Note:** If it does not display the corrected value of "20.9", press the ▲ and ▼ buttons to adjust the displayed value to the standard value of "20.9".

5. Press the **ENTER** button again to confirm and complete the O<sub>2</sub> sensor calibration procedure.
6. At this point, the sensor is now calibrated and should be reading accurately.

## Data Stream Output

Using Terminal application, a data stream can be viewed from the RS-232 output, connect RS-232/USB cable between the product and terminal/PC and use the following setting to view the data stream.

Terminal Settings:

- Bits per second: 9600
- Data bits: 8
- Parity: None
- Stop bits: 1

47060100000209 = O<sub>2</sub> data (Probe 3) +20.9 % O<sub>2</sub>

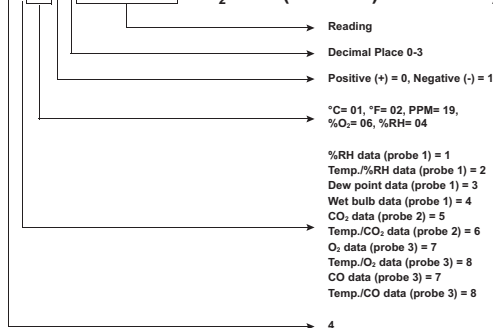

## 3.5mm Terminal to RS-232 Serial Connection

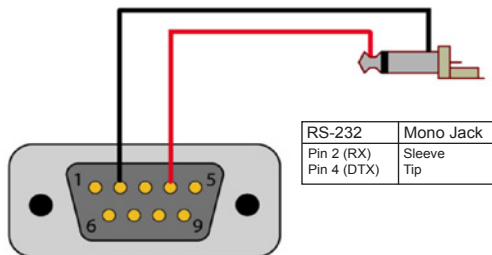

## System Reset

If the meter becomes unresponsive or if the display freezes, the Reset Pin can be used to reset the instrument.

1. Use a paper clip or any similar small object to press the Reset Pin.
2. After pressing the Reset Pin, power the meter back up by holding the **POWER** button for 2 seconds.
3. If resetting the meter does not resolve the issue, please return the meter to the nearest authorized REED distributor or authorized Service Center for repair.

## Battery Replacement

When the low battery icon  appears on the LCD, the batteries must be replaced.

1. Remove the two (2) Phillips screws on the back of the meter directly located above the top of the kickstand.
2. Remove the battery cover.
3. Replace 6 x "AA" batteries.
4. Secure the battery cover with the two (2) Phillips screws.

## Applications

Environmental Monitoring in:

- Schools
- Office buildings
- Greenhouses
- Factories
- Hotels
- Hospitals
- Areas where high levels of carbon dioxide are generated

## Accessories and Replacement Parts

**R9910SD-TH** Replacement Temp/Humidity Probe

**R9910SD-CO** Replacement CO Probe

**R9910SD-CO2** Replacement Carbon Dioxide Probe

**R9910SD-O2** Replacement Oxygen Probe

**R1500** Tripod

**RSD-ADP-NA** Power Supply, 110V

**RSD-ADP-EU** Power Supply, 220V

**CA-05A** Soft Carrying Case

**R8888** Deluxe Hard Carrying Case

**SD-4GB** 4GB Class 4 SDHC Memory Card

**RSD-16GB** 16GB Micro SD Memory Card w/ Adapter

Don't see your part listed here? For a complete list of all accessories and replacement parts visit your product page on [www.REEDInstruments.com](http://www.REEDInstruments.com).

## Frequently Asked Questions (FAQ's)

### I cannot turn off my meter, do you know why?

Often times, the meter cannot be turned off because it is in recording mode ("REC" mode). Make sure to exit that function by holding down the **REC** button before attempting to turn the meter off.

### How long can I record for?

Battery life will depend on a number of factors:

- Quality of Battery
- Whether the beeper is ON or OFF
- Whether the backlight is ON or OFF
- Environmental Conditions during data logging

As a reference, using alkaline batteries with both the backlight and beeper on while automatic data logging at a 2 second sampling rate; the batteries lasted approx. 14 hours.

*continued...*

**REED**

**24**



## **Can this model be used for continuous monitoring or does it always turn off after 10 minutes? Can the auto shut off be disabled?**

The meter is set to turn off after 10 minutes by default, however it can be disabled. (See *Enabling/Disabling Auto Power OFF* for details).

## **If I wanted to monitor CO/CO<sub>2</sub> and temp at the same time do all the probes have to be connected and can they be?**

Yes, the R9910SD can have three probes plugged in at the same time: the Humidity, CO<sub>2</sub>, and either the O<sub>2</sub> or the CO Probe. The meter will data log all three values, however, only one value can be displayed at one time on the LCD screen.

## **How many data points can it hold and does it hold them on the SD card only?**

The first time an SD card (Maximum size of 16Gb) is used in the meter, the SD card will generate a folder named AQA01. Within this folder, a new file named AQA01001.XLS is created when the data logger begins recording. This file is used until the Data has reached to 30,000 rows. At that point, the meter will then generate a new file with a subsequent number, for example AQA01002.XLS. The folder AQA01 can hold 99 .XLS files. When that number has been reached, the meter will then will generate a new folder with a subsequent number, for example AQA02. The maximum number of AQA-- folders is 10.

## **Product Care**

To keep your instrument in good working order we recommend the following:

- Store your product in a clean, dry place.
- Change the battery as needed.
- If your instrument isn't being used for a period of one month or longer please remove the battery.
- Clean your product and accessories with biodegradable cleaner. Do not spray the cleaner directly on the instrument. Use on external parts only.

## Product Warranty

REED Instruments guarantees this instrument to be free of defects in material or workmanship for a period of one (1) year from date of shipment. During the warranty period, REED Instruments will repair or replace, at no charge, products or parts of a product that proves to be defective because of improper material or workmanship, under normal use and maintenance. REED Instruments total liability is limited to repair or replacement of the product. REED Instruments shall not be liable for damages to goods, property, or persons due to improper use or through attempts to utilize the instrument under conditions which exceed the designed capabilities. In order to begin the warranty service process, please contact us by phone at 1-877-849-2127 or by email at [info@REEDInstruments.com](mailto:info@REEDInstruments.com) to discuss the claim and determine the appropriate steps to process the warranty.

## Product Disposal and Recycling



Please follow local laws and regulations when disposing or recycling your instrument. Your product contains electronic components and must be disposed of separately from standard waste products.

## Product Support

If you have any questions on your product, please contact your authorized REED distributor or REED Instruments Customer Service by phone at 1-877-849-2127 or by email at [info@REEDInstruments.com](mailto:info@REEDInstruments.com).

Please visit [www.REEDInstruments.com](http://www.REEDInstruments.com) for the most up-to-date manuals, datasheets, product guides and software.

*Product specifications subject to change without notice.  
All rights reserved. Any unauthorized copying or reproduction of this manual is strictly prohibited without prior written permission from REED Instruments.*

# REED INSTRUMENTS

## TEST & MEASURE WITH CONFIDENCE



Access our  
Product Catalog

Over 200 portable test and  
measurement instruments



# REED INSTRUMENTS

TEMPERATURE  
& HUMIDITY



SOUND



MOISTURE



AIR VELOCITY



ELECTRICAL

