

R7000SD

REED INSTRUMENTS

Data Logging Vibration Meter



Instruction Manual

Table of Contents

Introduction	3
Product Quality.....	3
Safety	4
Features.....	4
Included	4
Specifications.....	5-6
Instrument Description	7
Display Description	8
Operating Instructions.....	9-11
<i>Power ON/OFF</i>	9
<i>Vibration Sensor</i>	9
<i>Selecting Measurement Modes</i>	9
<i>Changing Units of Measure</i>	10
<i>Zero Adjustment</i>	10
<i>Max Hold Reset</i>	10
<i>Data Hold</i>	11
<i>Recording Maximum and Minimum Readings</i>	11
<i>Backlight</i>	11
Setup Mode	12-14
<i>Setting the Time and Date (dAtE)</i>	12
<i>Setting Data Decimal Format (dEC)</i>	13
<i>Enabling/Disabling Auto Power Off (PoFF)</i>	13
<i>Enabling/Disabling the Beeper (bEEP)</i>	13
<i>Setting the Data Logging Sampling Rate (SP-t)</i>	14
<i>Formatting the SD Card (Sd F)</i>	14
<i>Verify Set Time and Date</i>	14
<i>Verify Sampling Rate</i>	14

continued...

Data Logging	15
<i>Data Recording Modes</i>	15
<i>Manual Data Logging Mode</i>	15
<i>Automatic Data Logging Mode</i>	16
<i>Transferring Data from the SD Memory Card to a Computer</i>	16
Data Stream Output	17
<i>3.5mm Terminal to RS-232 Serial Connection</i>	18
System Reset	18
Battery Replacement	18
Applications	19
Accessories and Replacement Parts	19
Appendix	20
Frequently Asked Questions (FAQ's)	21
Product Care	21
Product Warranty	22
Product Disposal and Recycling	22
Product Support	22

Introduction

Thank you for purchasing your REED R7000SD Data Logging Vibration Meter. Please read the following instructions carefully before using your instrument. By following the steps outlined in this manual your meter will provide years of reliable service.

Product Quality

This product has been manufactured in an ISO9001 facility and has been calibrated during the manufacturing process to meet the stated product specifications. If a certificate of calibration is required please contact the nearest authorized REED distributor or authorized Service Center. Please note an additional fee for this service will apply.

Safety

Never attempt to repair or modify your instrument. Dismantling your product, other than for the purpose of replacing batteries, may cause damage that will not be covered under the manufacturer's warranty. Servicing should only be provided by an authorized service center.

Features

- Measures velocity and acceleration to determine vibration level
- User selectable unit of measure (metric or imperial)
- RMS, Peak hold, Data hold and Max/Min functions
- 10Hz to 1kHz frequency range
- Basic accuracy of +/-5%
- Real-time datalogger with integrated SD memory card
- User selectable sampling rate from 1 to 3600 seconds
- Easy-to-read backlit LCD display
- Tripod mount for long-term monitoring
- Meets ISO 2954 standards
- Low battery indicator and auto shut off

Included

- Vibration Probe with 47.2" (1.2m) Cable
- Hard Carrying Case
- Batteries

Specifications

Acceleration

Measuring Range:	0.5 to 199.9m/s ² 0.05 to 20.39g 2 to 656ft/s ²
Accuracy:	±(5% + 5 dgt)
Resolution:	0.1m/s ² 0.01g 1ft/s ²

Velocity

Measuring Range:	0.5 to 199.9mm/s 0.05 to 19.99cm/s 0.02 to 7.87in/s
Accuracy:	±(5% + 5 dgt)
Resolution:	0.1mm/s 0.01cm/s 0.01in/s

General Specifications

Response Time:	1 second
Frequency Range:	10Hz to 1KHz
Display:	4-digit LCD
Backlit Display:	Yes
RMS, Peak and Max Hold Measurements:	Yes
Data Hold:	Yes
Min:	Yes
Max:	Yes
Zero Adjustment:	Yes
Datalogging Capabilities:	Yes
Real-Time Clock and Date Stamp:	Yes

continued...

Selectable Sampling Rate:	Yes (1, 2, 5, 10, 30, 60, 120, 300, 600, 1800, 3600 seconds)
External Memory:	Yes, expandable up to 16GB with SD card (optional)
Auto Shut-off:	Yes (after 10 minutes/off)
Kick Stand:	Yes
Tripod Mountable:	Yes
Low Battery Indicator:	Yes
Probe Cable Length:	47.2" (1.2m)
Power Supply:	6 x AA batteries or AC Adapter (optional)
Data Output:	Yes (RS-232)
Product Certifications:	CE
Operating Temperature:	0 to 122°F (0 to 50°C)
Storage Temperature:	14 to 140°F (-10 to 60°C)
Operating Humidity Range:	10 to 85%
Dimensions:	Instrument: 9.7 x 2.7 x 1.8" (203 x 76 x 38mm) Probe: 1.5 x 0.6" (37 x 16mm)
Weight	Instrument: 17.3oz (515g) Probe: 3.5oz (99g)

Instrument Description

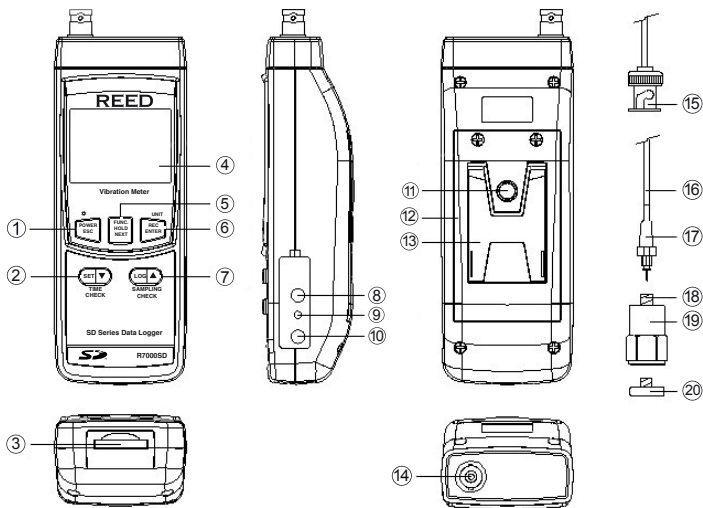

- | | |
|------------------------------------|-----------------------------------|
| 1. POWER/Backlight/ESC Button | 10. Power Adapter Input |
| 2. SET/Down/Time Button | 11. Tripod Mounting Screw |
| 3. SD Card Slot | 12. Battery Cover |
| 4. LCD Display | 13. Kickstand |
| 5. HOLD/FUNCTION/
NEXT Button | 14. BNC Input Socket |
| 6. REC/ENTER/UNIT Button | 15. Cable BNC Plug |
| 7. LOG/Up/Sampling
Check Button | 16. Sensor Cable |
| 8. RS-232 Output Jack | 17. Mini Plug |
| 9. Reset Pin | 18. Vibration Sensor Input Socket |
| | 19. Vibration Sensor |
| | 20. Magnetic Base |

Display Description

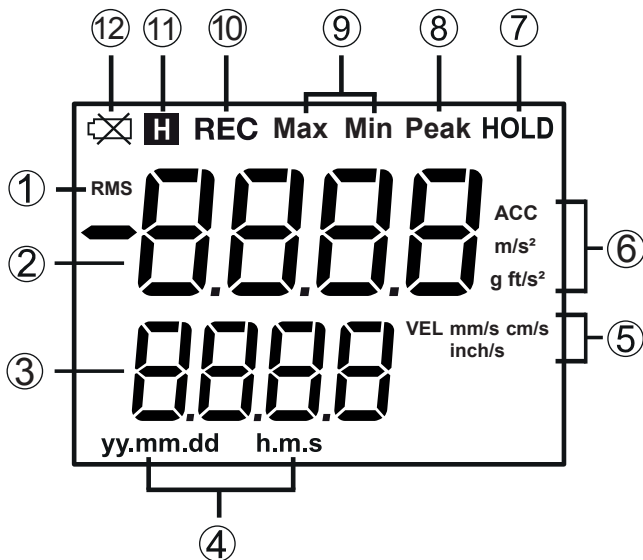

- | | |
|----------------------------------|-----------------------------------|
| 1. RMS Mode Indicator | 7. Maximum Peak Hold Indicator |
| 2. Measurement Reading Indicator | 8. Peak Mode Indicator |
| 3. Date & Time Values | 9. Maximum and Minimum Indicators |
| 4. Date/Time Stamp | 10. Record Mode Indicator |
| 5. Velocity Unit of Measure | 11. Data Hold Indicator |
| 6. Acceleration Unit of Measure | 12. Low Battery Indicator |

Operating Instructions

Power ON/OFF

Turn the meter on by pressing the **POWER** button. To turn the meter off, press and hold the **POWER** button for 2 seconds.

Note: This meter can be powered by either six (6) "AA" batteries or AC adapter (sold separately).

Vibration Sensor

1. Plug in the BNC cable into the BNC input socket.
2. If the material under test is non-ferrous, place the vibration sensor on the surface to take a measurement.
3. If the material under test is ferrous, connect the magnetic base to the vibration sensor. Place the vibration sensor and magnetic base on the surface to take a measurement. Do not touch the sensor cable when taking measurements.

Selecting Measurement Modes

The R7000SD has 3 measurement modes:

- Root Mean Square: Measures Acceleration and Velocity
 - PEAK: Measures the Peak value of vibration
 - MAX HOLD: Measures and updates the maximum Peak Value
1. When the meter is on, press and hold the **FUNCTION** button to toggle between "RMS", "Peak" & "Max HOLD".
 2. Release the **FUNCTION** button to confirm selection.

continued...

Changing Units of Measure

1. Press and hold the UNIT button, while in RMS measurement mode.
2. The LCD display will toggle between the following units:

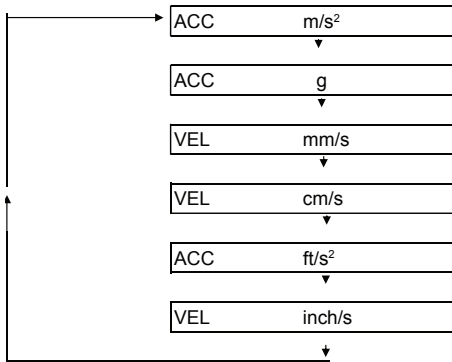

3. Release the UNIT button to select the displayed unit.
4. The selected unit will be saved as the new default.

Zero Adjustment

The zero adjustment is intended to remove small offsets caused by environmental changes.

1. Ensure the vibration sensor is properly secured to the meter.
2. Set the measurement function to "Acceleration" (m/s², g, ft/s²).
3. Keep the vibration sensor motionless so no signal is picked up.
4. Press and hold the **LOG** button for approx. 5 seconds or until a zero value is displayed.

Note: The zero adjustment function only works when the measured value is less than 10 digits.

Max Hold Reset

While in the Max Hold function, press and hold the **LOG** button for 3 seconds to clear the current max hold value.

continued...

Data Hold

1. While taking a measurement, press the **HOLD** button to freeze the current readings on the display.
2. While in this mode the **H** symbol will appear on the LCD.
3. Press the **HOLD** button again to resume normal operation.

Note: When the Data Hold feature is active all buttons except the **POWER** button are disabled.

Recording Maximum and Minimum Readings

1. Press the **REC** button to enter recording mode as indicated by "REC" on the LCD. The meter will now begin recording maximum and minimum readings.
2. While in recording mode;
 - A) Press the **REC** button once and the maximum value will appear on the display as indicated by "REC MAX".
 - B) Press the **REC** button again and the minimum value will appear on the display as indicated by "REC MIN".
 - C) To exit recording mode and resume normal operation, press and hold the **REC** button for two seconds.

When in recording mode the **POWER** button is disabled and the meter cannot be turned off.

Backlight

After powering the meter ON, the LCD Backlight will turn on automatically. Press the BACKLIGHT button to turn the LCD Backlight on or off.

Setup Mode

1. Press and hold the **SET** button for 2 seconds to enter Setup Mode.
2. Press the **NEXT** button continuously to scroll through the following parameters.

Parameter	Description
dAtE	Set the time and date
dEC	Set the decimal format (USA (20.00) or European (20,00))
PoFF	Enable or disable the auto-power off function
bEEP	Turn the beeper on or off
SP-t	Set the data logging sampling rate
Sd F	Format the SD memory card

3. Once the appropriate parameter has been selected, follow the instructions below.

Note: The meter automatically exits out of the Setup mode if no key is pressed within 7 seconds.

Setting the Time and Date (dAtE)

1. Press the **ENTER** button when "dAtE" appears on the LCD.
2. Press the **▲** and **▼** buttons to adjust the year as indicated by "YY."
3. Press the **ENTER** button to confirm selection.
4. Repeat steps 2 and 3 for month, day, hour, minute and seconds as indicated by (mm/dd/h/m/s).
5. After each value has been selected and confirmed, it will automatically skip to the next parameter.

Note: At any time, you can press the **ESC** button to exit the Setup mode and resume normal operation. The internal clock will keep accurate time when the meter is powered off. When new batteries are installed the clock will have to be reset.

continued...

Setting Data Decimal Format (dEC)

Numeric formats vary in different countries. By default the meter is set to bASIC mode where a decimal point is used to separate units, (i.e. 20.00). The European format uses a comma (i.e. 20,00) to separate units. To change this setting, follow steps 1 and 2 when the "dEC" parameter appears on the LCD.

1. Press the ▲ and ▼ buttons to select between bASIC and Euro.
2. Press the **ENTER** button to confirm selection and skip to next parameter.

Note: At any time, you can press the **ESC** button to exit the Setup mode and resume normal operation.

Enabling/Disabling Auto Power Off (PoFF)

Follow steps 1 and 2 when "PoFF" appears on the LCD.

1. Press the ▲ and ▼ buttons to select between YES (enabled) or NO (disabled). With the Auto Power OFF feature enabled, the meter will automatically switch OFF after 10 minutes of inactivity to preserve battery life.
2. Press the **ENTER** button to confirm selection and skip to next parameter.

Note: At any time, you can press the **ESC** button to exit the Setup mode and resume normal operation.

Enabling/Disabling the Beeper (bEEP)

Follow steps 1 and 2 when "bEEP" appears on the LCD.

1. Press the ▲ and ▼ buttons to select between ON (enabled) or OFF (disabled).
2. Press the **ENTER** button to confirm selection and skip to next parameter.

Note: At any time, you can press the **ESC** button to exit the Setup mode and resume normal operation.

continued...

Setting the Data Logging Sampling Rate (SP-t)

Follow steps 1 and 2 when "SP-t" appears on the LCD.

1. Press the ▲ and ▼ buttons to adjust the sampling rate between 0, 1, 2, 5, 10, 30, 60, 120, 300, 600, 1800, and 3600 seconds.
2. Press the **ENTER** button to confirm selection and skip to next parameter.

Note: At any time, you can press the **ESC** button to exit the Setup mode and resume normal operation.

Formatting the SD Card (Sd F)

Follow steps 1 through 5 when "Sd F" appears on the LCD.

1. Press the ▲ and ▼ buttons to select "YES" to format the card. Select "NO" to abort.
2. Press the **ENTER** button to confirm selection.
3. Press the **ENTER** button again to re-confirm.
4. The meter will format the SD card and automatically return to the Setup menu when formatting is complete.
5. Press the **ESC** button to exit the Setup mode and resume normal operation.

Note: It is recommended that new SD cards should be formatted prior to first use. If the formatting process fails, the meter will display -E-.

Verify Set Time and Date

During normal operation, press the **TIME CHECK** button to display the year, month, day, hour and minutes.

Verify Sampling Rate

During normal operation, press the **SAMPLING CHECK** button to view the selected sampling rate.

Data Logging

Data Recording Modes

Manual Data Logging: Press the **LOG** button to manually log up to 99 readings on a SD memory card (see *Manual Data Logging Mode* for full setup instructions).

Automatic Data Logging: Setup the meter parameters in order to automatically log data on a SD memory card. The number of data points is limited by the size of the memory card.

Note: It is recommended to use a class 4 SDHC memory card between 1 and 16Gb. Insert the SD memory card in the slot at the bottom of the meter. The card must be inserted with the label side facing the rear of the meter.

Manual Data Logging Mode

In manual mode, the **LOG** button is pressed to manually log a reading on the inserted SD card at any time. In order to setup the meter for manual data logging, follow steps 1 through 7 below.

1. Set the data logging sampling rate to "0" seconds (see *Setting the Data Logging Sampling Rate* section for details).
2. Press the **REC** button and "REC" will appear on the LCD.
3. The meter will also display P-X (X = memory position number between 1 and 99).
4. Press the **▲** and **▼** buttons to select one of the 99 data memory positions in which to record.
5. Press the **ENTER** button to confirm selection.
6. Press the **LOG** button to save a reading to memory. "REC" will flash each time a data point is stored.

Note: If a card is not inserted or the card is defective, the meter will flash "CArD -E-". In this case, power the meter OFF and try again with another SD memory card or verify that the card is correctly inserted.

7. To exit manual data logging mode, press and hold the **REC** button 2 seconds to resume normal operation.

continued...

Automatic Data Logging Mode

In automatic mode the desired data logging sampling rate is set to 1, 2, 5, 10, 30, 60, 120, 300, 600, 1800 or 3600 seconds prior to recording (see *Setting the Data Logging Sampling Rate* section for details). In order to setup the meter for automatic data logging, follow steps 1 through 5 below.

1. To begin a data logging session, press the **REC** button and "REC" will appear on the LCD.
2. Press the **LOG** button. The meter will scan for a SD memory card.
Note: If a card is not inserted or the card is defective, the meter will flash "CARd -E-" indefinitely. In this case, power the meter OFF and try again with another SD memory card or verify that the card is correctly inserted.
3. The "REC" icon will appear on the LCD and will continuously flash while in a data logging session.
4. To pause the data logging session, press the **LOG** button and "REC" will stop flashing. To resume press the **LOG** button again.
5. To end the current data logging session, pause the data logging session and hold the **REC** button until "REC" disappears.

Transferring Data from the SD Memory Card to a Computer

1. While the meter is powered Off remove the SD memory card from the SD card slot.
2. Insert the SD memory card into the computer.
3. Open the file(s) with Excel. See sample below:

Date	Time	Display	1 Unit
19-07-10	11:04:23	1.1	m/Sec ²
19-07-10	11:27:03	1.3	m/Sec ²
19-07-10	11:27:08	0.7	m/Sec ²
19-07-10	11:27:13	1.3	m/Sec ²
19-07-10	11:29:55	1.2	m/Sec ²
19-07-10	11:30:00	1.1	m/Sec ²
19-07-10	11:30:05	1.2	m/Sec ²
19-07-10	11:30:07	1.3	m/Sec ²
19-07-10	11:30:15	1	m/Sec ²
19-07-10	11:30:20	1.1	m/Sec ²
19-07-10	11:30:25	1.2	m/Sec ²

continued...

The raw data can be used to create a graph in Excel. See sample below:

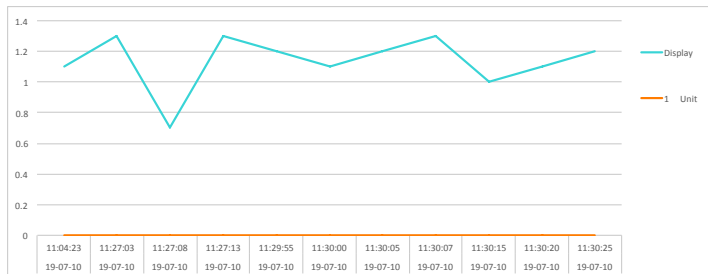

Data Stream Output

Using Terminal application, a data stream can be viewed from the RS-232 output, connect RS-232/USB cable between the product and terminal/PC and use the following setting to view the data stream.

Terminal Settings:

- Bits per second: 9600
- Data bits: 8
- Parity: None
- Stop bits: 1

41920100001999 = 199.9 m/s²

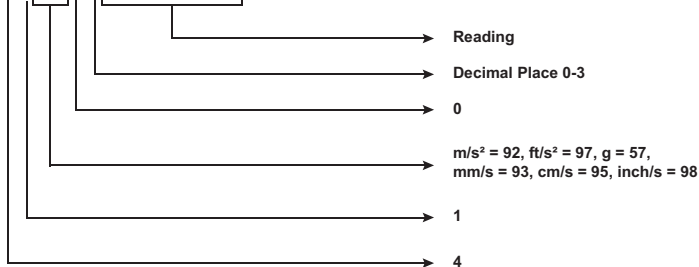

continued...

3.5mm Terminal to RS-232 Serial Connection

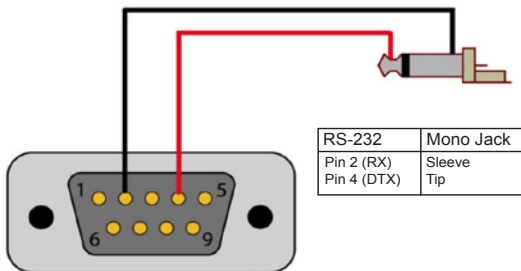

System Reset

If the meter becomes unresponsive or if the display freezes, the Reset Pin can be used to reset the instrument.

1. Use a paper clip or any similar small object to press the Reset Pin.
2. After pressing the Reset Pin, power the meter back up by holding the **POWER** button for 2 seconds.
3. If resetting the meter does not resolve the issue, please return the meter to the nearest authorized REED distributor or authorized Service Center for repair.

Battery Replacement

When the low battery icon  appears on the LCD, the batteries must be replaced.

1. Remove the two (2) Phillips screws on the back of the meter directly located above the top of the kickstand.
2. Remove the battery cover.
3. Replace 6 x "AA" batteries.
4. Secure the battery cover with the two (2) Phillips screws.

Applications

- Evaluation of rotational industrial equipment (fans, pumps, turbines, compressors, conveyors, motors and bearings)
- Equipment shock and pulsation checks
- Preventative maintenance programs
- Power hand tools and transportation equipment

Accessories and Replacement Parts

R7000SD-PROBE Replacement Probe for R7000SD

SD-VMB Magnetic Base for R7000SD

R1500 Tripod

RSD-ADP-NA Power Supply, 110V

RSD-ADP-EU Power Supply, 220V

CA-05A Soft Carrying Case

R8888 Deluxe Hard Carrying Case

SD-4GB 4GB Class 4 SDHC Memory Card

RSD-16GB 16GB Micro SD w/ Adapter

Don't see your part listed here? For a complete list of all accessories and replacement parts visit your product page on www.REEDInstruments.com.

continued...

REED

19

Appendix

ISO 10816 Standards

This standard is used to evaluate the severity of overall vibration levels with the help of the vibration chart below.

ISO 10816-3 separates the working conditions into four zones:

- Zone A (Green): Vibration values from class machines just put into operation (Good Condition)
- Zone B (Yellow): Continuous operation without any restrictions (Satisfactory Condition)
- Zone C (Orange): Condition is acceptable only for a limited period of time (Unsatisfactory Condition)
- Zone D (Red): Dangerous vibration values. Damage could occur at any time (Unacceptable Condition)

Machine		Class I Small Machines	Class II Medium Machines	Class III Large Rigid Foundation	Class IV Large Soft Foundation
in/s	mm/s				
Vibration Velocity V_{ms}	0.01	0.28			
	0.02	0.45			
	0.03	0.71			
	0.04	1.12		Good	
	0.07	1.80			
	0.11	2.80		Satisfactory	
	0.18	4.50			
	0.28	7.10		Unsatisfactory	
	0.44	11.2			
	0.70	18.0		Unacceptable	
	0.71	28.0			
1.10	45.0				

Class I: Small machines/production electrical motors up to 15kW.

Class II: Medium-sized machines/electrical motors with a maximum 75kW output without special foundations.

Class III: Large machines on heavy foundations that are relatively stiff in the direction of the vibration measurements.

Class IV: Large prime-movers and other large machines with rotating masses mounted on foundations that are relatively soft in the direction of vibration measurements (for example, turbo generator sets and gas turbines with outputs greater than 10MW).

Frequently Asked Questions (FAQ's)

I cannot turn off my meter, do you know why?

Often times, the meter cannot be turned off because it is in recording mode ("REC" mode). Make sure to exit that function by holding down the **REC** button before attempting to turn the meter off.

How long can I record for?

Battery life will depend on a number of factors:

- Quality of Battery
- Whether the beeper is ON or OFF
- Whether the backlight is ON or OFF
- Environmental Conditions during data logging

As a reference, using alkaline batteries with both the backlight and beeper on while automatic data logging at a 2 second sampling rate; the batteries lasted approx. 14 hours.

Product Care

To keep your instrument in good working order we recommend the following:

- Store your product in a clean, dry place.
- Change the battery as needed.
- If your instrument isn't being used for a period of one month or longer please remove the battery.
- Clean your product and accessories with biodegradable cleaner. Do not spray the cleaner directly on the instrument. Use on external parts only.

Product Warranty

REED Instruments guarantees this instrument to be free of defects in material or workmanship for a period of one (1) year from date of shipment. During the warranty period, REED Instruments will repair or replace, at no charge, products or parts of a product that proves to be defective because of improper material or workmanship, under normal use and maintenance. REED Instruments total liability is limited to repair or replacement of the product. REED Instruments shall not be liable for damages to goods, property, or persons due to improper use or through attempts to utilize the instrument under conditions which exceed the designed capabilities. In order to begin the warranty service process, please contact us by phone at 1-877-849-2127 or by email at info@REEDInstruments.com to discuss the claim and determine the appropriate steps to process the warranty.

Product Disposal and Recycling



Please follow local laws and regulations when disposing or recycling your instrument. Your product contains electronic components and must be disposed of separately from standard waste products.

Product Support

If you have any questions on your product, please contact your authorized REED distributor or REED Instruments Customer Service by phone at 1-877-849-2127 or by email at info@REEDInstruments.com.

Please visit www.REEDInstruments.com for the most up-to-date manuals, datasheets, product guides and software.

*Product specifications subject to change without notice.
All rights reserved. Any unauthorized copying or reproduction of this manual is strictly prohibited without prior written permission from REED Instruments.*

REED INSTRUMENTS

TEST & MEASURE WITH CONFIDENCE



Access our
Product Catalog

Over 200 portable test and
measurement instruments



REED INSTRUMENTS

TEMPERATURE
& HUMIDITY



SOUND



MOISTURE



AIR VELOCITY



ELECTRICAL

