

User's Guide

QL-810W
QL-820NWB

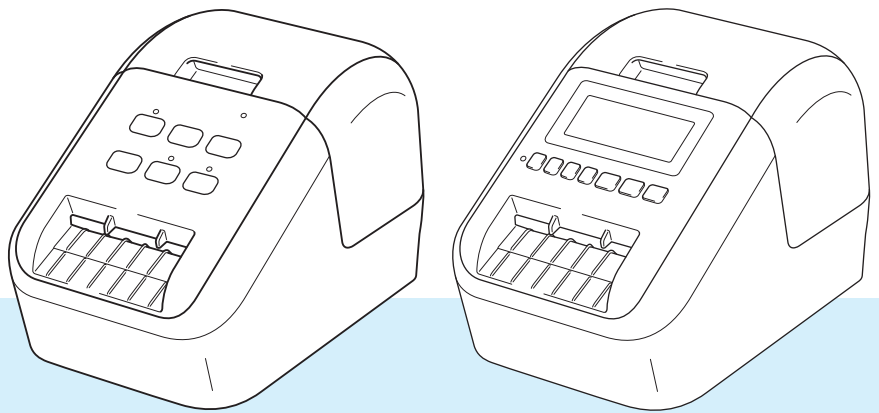

Read the *Product Safety Guide* first, then read the *Quick Setup Guide* for the correct setup procedure. After reading this guide, keep it in a safe place for quick reference.

Version 06

Introduction

Important Notice

- The contents of this document and the specifications of this product are subject to change without notice.
- Brother reserves the right to make changes without notice in the specifications and materials contained herein and shall not be responsible for any damages (including consequential) caused by reliance on the materials presented, including but not limited to typographical and other errors relating to the publications.
- Screen images in this document may differ depending on your computer's operating system, your product model, and software version.
- Before using the Label Printer, make sure you read all the documents included with the Label Printer for information about safety and operation.
- The Label Printer shown in the illustrations may be different from your Label Printer.
- The available options and supplies may vary depending on the country.

Available Manuals





Product Safety Guide ¹	This guide provides safety information; read it before you use the Label Printer.
Quick Setup Guide ¹	This guide provides basic information about using the Label Printer along with troubleshooting tips.
User's Guide ²	This guide provides additional information about the Label Printer settings and operations, network connection and settings, troubleshooting tips, and maintenance instructions.

¹ Printed manual in the box

² PDF manual on the Brother support website



Symbols Used in This Guide

The following symbols are used throughout this guide:

 WARNING	Tells you what to do to avoid the risk of injury.
 CAUTION	Tells you about procedures you must follow to avoid minor personal injury or damage to the Label Printer.
 Important	Indicates information or directions that should be followed. Ignoring them may result in damage, or failed operations.
 Note	Indicates notes that provide information or directions that can help you better understand and use the product more efficiently.

General Precautions

DK Roll (DK Label and DK Tape)

- Use only genuine Brother accessories and supplies (with ,  marks). DO NOT use any unauthorized accessories or supplies.
- If the label is attached to a wet, dirty, or oily surface, it may peel off easily. Before applying the label, clean the surface to which the label will be applied.
- DK Rolls use thermal paper or film that can fade in color or peel off surfaces if exposed to ultraviolet light, wind or rain.
- DO NOT expose the DK Rolls to direct sunlight, high temperatures, high humidity, or dust. Store in a cool, dark place. Use the DK Rolls soon after opening the package.
- Scratching the printed surface of the label with your finger nails or metal objects, or touching the printed surface with damp or wet hands can cause the color to change or fade.
- DO NOT apply labels to any persons, animals, or plants. In addition, never apply labels to public or private property without permission.
- As the end of the DK Roll is designed to not adhere to the label spool, the last label may not be cut correctly. If this happens, remove the remaining labels, insert a new DK Roll, and reprint the last label.
Note: To account for this, the number of DK Labels included on each DK Roll may be more than indicated on the package.
- When a label is removed after being applied to a surface, a portion of the label may remain applied.
- Prior to using CD/DVD labels, be sure to follow the instructions in your CD/DVD player's instruction guide regarding applying CD/DVD labels.
- DO NOT use CD/DVD labels in a slot loading CD/DVD player.
- DO NOT peel off the CD/DVD label once it is applied to the CD/DVD, a thin surface layer may come off, resulting in damage to the disc.
- DO NOT apply CD/DVD labels to CDs/DVDs designed for use with inkjet printers. Labels peel off these discs easily and using discs with peeling labels can result in loss or damage of data.
- When applying CD/DVD labels, use the applicator included with the CD/DVD label rolls. Failure to do so could cause damage to the CD/DVD player.
- Users shall take full responsibility for applying CD/DVD labels. Brother accepts no responsibility for any loss or damage of data caused by the inappropriate use of CD/DVD labels.
- Be careful not to drop the DK Roll.
- DK Rolls use thermal paper and thermal film. Both the label and print will fade with sunlight and heat. DO NOT use DK Rolls for any outdoor use that requires durability.
- Depending on the area, material, and environmental conditions, the label may unpeel or become irremovable, or the color of the label may change or be transferred to other objects. Before applying the label, check the environmental conditions and the material. Test the label by affixing a small piece of it to an inconspicuous area of the intended surface.
- If print results are not as expected, use the adjustment options in the printer driver or the Printer Setting Tool.

IMPORTANT NOTE

- This product is approved for use in the country of purchase only. Do not use this product outside the country of purchase as it may violate the wireless telecommunication and power regulations of that country.
- Windows Vista in this document represents all editions of Windows Vista.
- Windows 7 in this document represents all editions of Windows 7.
- Windows 8 in this document represents all editions of Windows 8.
- Windows 8.1 in this document represents all editions of Windows 8.1.
- Windows 10 in this document represents Windows 10 Home, Windows 10 Pro, Windows 10 Enterprise, and Windows 10 Education.
Windows 10 in this document does not represent Windows 10 Mobile, Windows 10 Mobile Enterprise, or Windows 10 IoT Core.
- Windows Server 2008 in this document represents all editions of Windows Server 2008 and Windows Server 2008 R2.
- Windows Server 2012 in this document represents all editions of Windows Server 2012 and Windows Server 2012 R2.
- Not all models are available in all countries.

©2019 Brother Industries, Ltd. All rights reserved.

Table of Contents

Section I Basic Operations

1	Setting Up the Label Printer	2
	Parts Description	2
	Front	2
	Rear	4
	Loading the DK Roll.....	5
	Connecting the AC Adapter	7
	Installing the Coin Cell Battery (QL-820NWB only)	8
	Turning Power On/Off.....	10
	Setting LCD Language (QL-820NWB only).....	10
	Setting the Time and Date (QL-820NWB only).....	10
	LCD (QL-820NWB only).....	11
	Screen	11
	LCD Settings	12
2	Printing Using a Computer (P-touch Editor)	22
	Installing the Software and Printer Drivers to a Computer.....	22
	Connecting the Label Printer to a Computer	23
	Connecting Using USB.....	23
	Connecting Using Wi-Fi.....	23
	Connecting Using a Wired LAN (QL-820NWB only)	28
	Bluetooth Connection (QL-820NWB only).....	28
	Connecting the Label Printer to a Barcode Scanner using Bluetooth (QL-820NWB only)	29
	Printing from a Computer.....	30
	Available Applications.....	30
	Creating Labels from Your Computer.....	31
	Attaching Labels	32
3	Printing Using the Mobile Device	33
	Installing Applications for Use with Mobile Devices.....	33
	Available Applications.....	33
	Connecting the Label Printer to a Mobile Device.....	33
	Printing from a Mobile Device.....	35
	Using a Mobile Device to Print Templates Created on a Computer	35
	Attaching Labels	36
4	Changing the Label Printer Settings	37
	Printer Setting Tool for Windows	37
	Before Using the Printer Setting Tool	37
	Using the Printer Setting Tool for Windows	38
	Communication Settings for Windows	40
	Settings Dialog Box	40
	Menu Bar	42
	General Tab.....	44

Wired LAN (QL-820NWB only) / Wireless LAN Tabs	46
Wireless Direct Tab	48
Bluetooth Tab (QL-820NWB only)	49
Applying Setting Changes to Multiple Printers	50
Device Settings for Windows	51
Settings Dialog Box	51
Menu Bar	53
Basic Tab	54
Advanced Tab	55
Display Tab (QL-820NWB only)	56
Management Tab	57
Applying Setting Changes to Multiple Label Printers	58
P-touch Template Settings for Windows	59
P-touch Template Settings Dialog Box	60
Printer Setting Tool for Mac	62
Before Using the Printer Setting Tool	62
Using the Printer Setting Tool for Mac	62
Settings Dialog Box	63
Basic Tab	64
Advanced Tab	65
Management Tab	65
Bluetooth Settings Tab (QL-820NWB only)	66
Wireless LAN Tab	66
Applying Setting Changes to Multiple Label Printers	67
Changing Settings When Printing from a Mobile Device	68

5 Printing Labels Using P-touch Template 69

P-touch Template Operations	69
Preparation	70
Specifying Settings in the P-touch Template Settings Tool	70
Connecting a Barcode Scanner (QL-820NWB only)	72
Standard Template Printing	73
Advanced Template Printing	75
Database Lookup Printing	78
Numbering (Serialized Number) Printing	81
Text Numbering (Serializing)	81
Barcode Numbering (Serializing)	82
Printing with Numbering (Serializing) Advanced Operation	83

6 Other Functions 84

Confirming the Label Printer Settings	84
2-Color Printing Configuration with Other Applications	85
Mass Storage Mode (QL-820NWB only)	86
Description	86
Using the Mass Storage Mode	87
JPEG Printing	88
Template Printing from the Label Printer Using the LCD menu (QL-820NWB only)	89
Remote Update	92
Distributed Printing (Windows only)	92

Section II Application

7	How to Use P-touch Editor	97
	For Windows.....	97
	Starting P-touch Editor	97
	Printing with P-touch Editor	99
	Transferring Data to the Label Printer	100
	Printing Using a 2.4" (62 mm) Black/Red DK Roll	101
	Adjusting the Color Range, Brightness, and Contrast	104
	For Mac.....	106
	Starting P-touch Editor	106
	Operation modes	107
	Transferring Data to the Label Printer	107
	2-Color Printing Configuration	108
	Adjusting the Color Range.....	109
	How to use the P-touch Address Book (Windows only)	110
	Starting the P-touch Address Book	110
	Creating a new contact.....	112
8	How to use P-touch Editor Lite (Windows only)	114
	How to use P-touch Editor Lite (QL-810W only) (Windows only)	114
	How to use P-touch Editor Lite LAN (Windows only).....	118
9	How to Use P-touch Transfer Manager and P-touch Library (Windows only)	123
	P-touch Transfer Manager.....	123
	Transferring the Template to P-touch Transfer Manager	123
	Transferring Templates or Other Data from the Computer to the Label Printer	126
	Backing up Templates or Other Data Saved in the Label Printer	131
	Deleting Label Printer Data.....	132
	Creating Transfer Files and Transfer Package Files	133
	P-touch Library	134
	Starting P-touch Library	134
	Opening and Editing Templates	136
	Printing Templates.....	137
	Searching for Templates.....	138
10	Transferring Templates with P-touch Transfer Express (Windows only)	140
	Preparing P-touch Transfer Express	140
	Transferring the Template to P-touch Transfer Manager	141
	Saving the Template as a Transfer Package File (.pdz).....	142
	Distributing the Transfer Package File (.pdz) and P-touch Transfer Express to the User	144
	Transferring the Transfer Package File (.pdz) to Your Label Printer	145
11	How to Update P-touch Software	148
	Updating P-touch Editor and P-touch Address Book (Windows only)	148
	For Windows.....	148
	For Mac	150

Updating P-touch Editor Lite (Windows only) and the Firmware	151
For Windows.....	151
For Mac	153

Section III Network

12	Introduction	156
	Network Features	156
13	Changing Your Label Printer Network Settings	157
	Changing Your Label Printer's Network Settings (IP Address, Subnet Mask and Gateway)	157
	Using the BRAdmin Light Utility (Windows only)	157
	Other Management Utilities	159
	Using Web Based Management (Web Browser).....	159
	Using the BRAdmin Professional Utility (Windows only)	159
14	Web Based Management	160
	Overview.....	160
	Configuring the Printer Settings Using Web Based Management (Web Browser).....	161

Section IV Appendix

15	Resetting the Label Printer	163
	Resetting All Settings to the Factory Settings Using the Label Printer Buttons (QL-810W only)	163
	Resetting Data Using the LCD menu (QL-820NWB only)	163
	Resetting Data Using the Printer Setting Tool	164
16	Maintenance	165
	Cleaning the Exterior of the Unit.....	165
	Cleaning the Print Head.....	165
	Cleaning the Roller	165
	Cleaning the Label Outlet	167
17	Troubleshooting	168
	Overview.....	168
	Printing Problems	169
	Network Setup Problems.....	174
	Label Printer Cannot Print over the Network	
	Label Printer Is Not Found on the Network Even after Successful Installation	176
	Security Software Problems	176
	Checking the Operation of Network Devices.....	177
	Version Information	177

	LED Indications.....	178
	QL-810W	178
	QL-820NWB	180
	Troubleshooting.....	182
18	Product Specifications	183
	Label Printer Specifications	183
19	Notes on Using P-touch Transfer Manager	185
	Notes on Creating Templates	185
	Notes on Transferring Templates	185
	Notes on Transferring Data Other Than Templates	186
20	Network Terms and Information	187
	Supported Protocols and Security Features	187
	Types of Network Connections and Protocols.....	188
	Types of Network Connections.....	188
	Configuring Your Label Printer for a Network.....	190
	IP Addresses, Subnet Masks and Gateways	190
	Wireless Network Terms and Concepts	192
	Security Terms	192
21	List of Barcodes for the P-touch Template Function	196
	General Procedure for the P-touch Template Function.....	196
	List of Barcodes for Specifying Settings	197
22	Using the Optional Battery Unit (Rechargeable Li-ion Battery included)	200
	Charging the Optional Battery Unit (PA-BU-001)	200
	Discontinue charging the Battery Unit	201
	Product Specifications	202
23	Using the Brother Barcode Scanner (Optional: PA-BR-001) (QL-820NWB only)	203



Basic Operations

Setting Up the Label Printer	2
Printing Using a Computer (P-touch Editor)	22
Printing Using the Mobile Device	33
Changing the Label Printer Settings	37
Printing Labels Using P-touch Template	69
Other Functions	84

1

Setting Up the Label Printer

1

Parts Description

Front

QL-810W

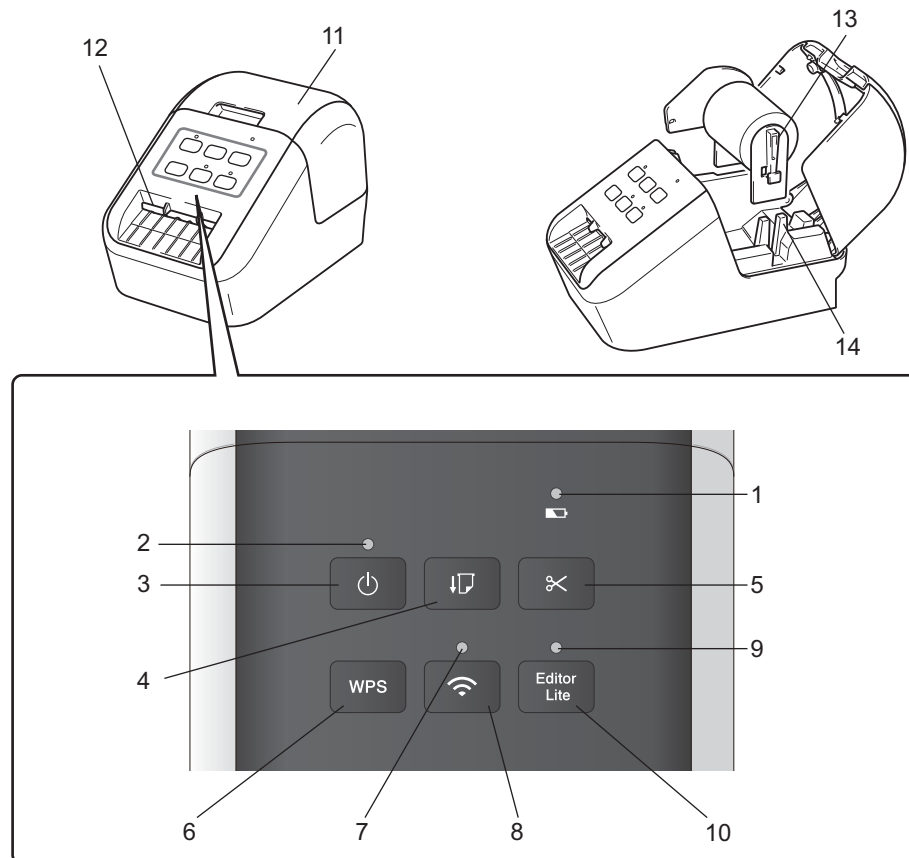

- 1 Battery LED
- 2 Status LED
- 3 Power Button
- 4 Feed Button
- 5 Cutter Button
- 6 WPS Button
- 7 Wi-Fi LED

- 8 Wi-Fi Button
- 9 Editor Lite LED
- 10 Editor Lite Button
- 11 DK Roll Compartment Cover
- 12 Label Output Slot
- 13 Roll Spool Arm
- 14 Roll Spool Guide

QL-820NWB

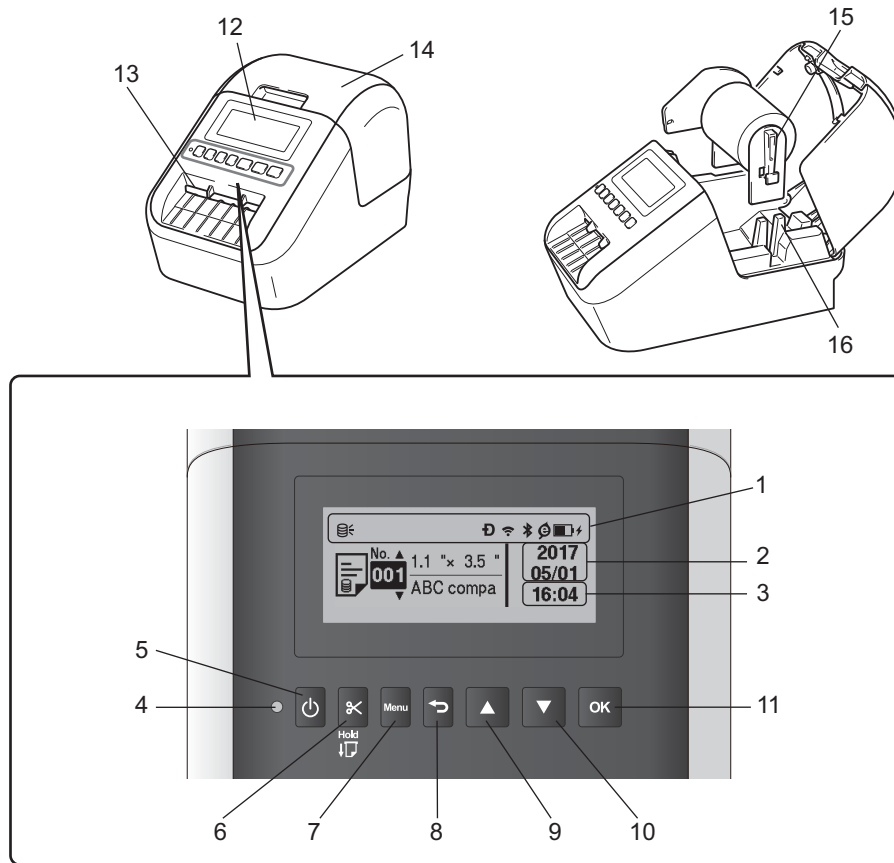

- 1 Indicator Display
- 2 Date Display
- 3 Time Display
- 4 Status LED
- 5 Power Button
- 6 Cutter Button
- 7 Menu Button
- 8 Cancel Button
- 9 Up Arrow Button
- 10 Down Arrow Button
- 11 OK Button
- 12 LCD

- 13 Label Output Slot
- 14 DK Roll Compartment Cover
- 15 Roll Spool Arm
- 16 Roll Spool Guide

Rear

QL-810W

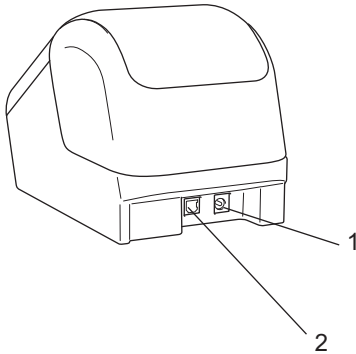

QL-820NWB

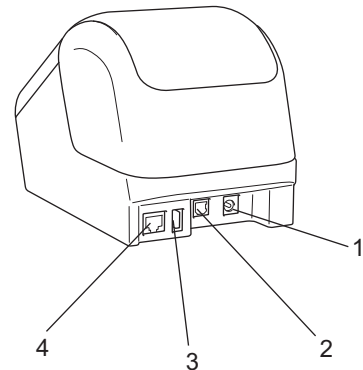

- 1 AC Adapter Port
- 2 USB Port
- 3 USB Host
- 4 LAN Port

⚠ Important

Before using the Label Printer, make sure you remove the Protective Sheet, as shown below:

- 1 Make sure that the Label Printer is turned Off.
Hold the Label Printer by the front, and firmly lift the DK Roll Compartment Cover to open it.
- 2 Remove the Protective Sheet from the Label Output Slot.



- **Do not throw away the Protective Sheet.**
- When the Label Printer is not in use, lift the DK Roll Compartment Cover and remove any DK Rolls from inside the Label Printer. Then, insert the Protective Sheet into the Label Output Slot to maintain good printing quality.

Loading the DK Roll

- 1 Make sure that the Label Printer is turned Off.
Hold the Label Printer by the front, and firmly lift the DK Roll Compartment Cover to open it.



- 2 After removing the Protective Sheet, place the DK Roll into the Roll Spool Guide.
 - Make sure that the Roll Spool Arm is inserted firmly in the Roll Spool Guide.
 - Make sure the Stabilizer (1) slides into the notch of the Label Printer.

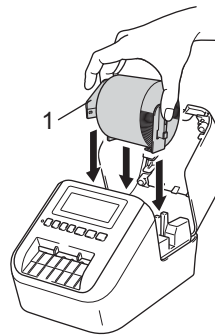

Note

If using P-touch Editor, select the DK Roll size in **[Paper Type]** (Windows) / **[Print Media]** (Mac) drop-down list. For more information, see *DK Label & Tape Guide* which is included in the package or the *How to Use P-touch Editor* on page 97.

- 3 Thread the DK Roll through the Label Printer.
 - Align the edge of the DK Roll with the upright edge of the Label Output Slot.
 - Insert the first label into the slot inside the compartment.
 - Push the label through the Label Output Slot until the end reaches the mark, as shown below.

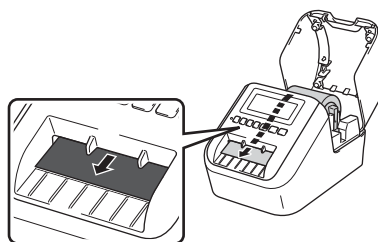

- 4 Close the DK Roll Compartment Cover.
When you press the Power (⏻) Button to turn the Label Printer On, the end of the DK Roll aligns automatically.

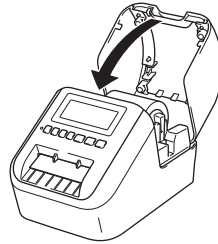

! **Important** Do not leave any printed labels in the Label Printer. Doing so will cause the labels to jam.

Connecting the AC Adapter

Connect the AC Adapter to the Label Printer and to the AC Power Cord. Then, plug the AC Power Cord into a grounded AC power outlet.

The PA-BU-001 (optional Battery Unit) can also be used.

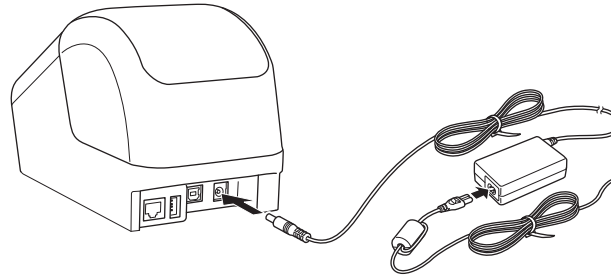

Installing the Coin Cell Battery (QL-820NWB only)

A coin cell battery is used as a backup power supply to maintain the settings for the internal clock. Please note that battery power will be consumed even if the Label Printer is not in use.

- 1 The Label Printer has a preinstalled coin cell battery. Make sure that the Label Printer is turned Off. Hold the Label Printer by the front, and firmly lift the DK Roll Compartment Cover to open it.
- 2 Remove the insulation seal on the coin cell battery.

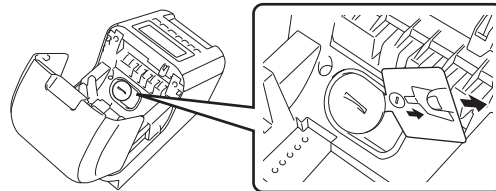

! Important

- Using a coin or similar object, slowly turn the coin cell battery cover in the direction of the arrow on the battery cover until it stops, and then remove the coin cell battery cover. Do not turn the coin cell battery cover past the unlock position, or you may damage it.

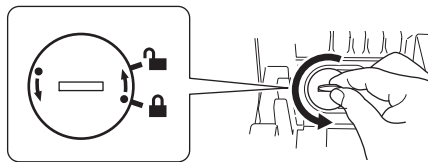

- Replace the coin cell battery. Be sure to insert the new battery with the + and - sides facing the correct direction. Using a coin or similar object, slowly turn the coin cell battery cover in the opposite direction of the arrow on the battery cover until it locks into place.

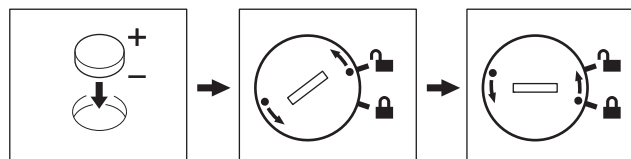

⚠ CAUTION

- Remove the battery if you do not intend to use the Label Printer for an extended period of time.
- Dispose of the battery at an appropriate collection point, not in the general waste stream. Be sure to observe all applicable federal, state, and local regulations.
- When storing or discarding a battery, wrap it with cellophane tape to prevent it from short-circuiting. (see illustration)

- 1 Cellophane tape**
- 2 Coin Cell battery**

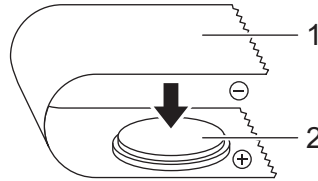

- We recommend replacing the battery every two years.
- If the clock resets while you are powering the Label Printer using the AC Power Cord, it is time to replace the battery. We recommend using a battery from Hitachi, Maxell, or FDK.

Turning Power On/Off

On: Press the Power (⏻) Button to turn the Label Printer On. The Status LED turns green.

Off: Press and hold the Power (⏻) Button again to turn the Label Printer Off.

Important

When turning the Label Printer Off, do not remove the battery or disconnect the AC Adapter until the orange Status LED turns Off.

Setting LCD Language (QL-820NWB only)

- 1 Press the Menu Button.
- 2 Press the ▲ or ▼ Button to select the [Administration] menu, and then press the OK Button.
- 3 Select [🗨 Language], scroll to select your language, and then press the OK Button.

Note

The first time you start up the Label Printer, the language configuration is automatically displayed without going through the menu.

Setting the Time and Date (QL-820NWB only)

Adjust the clock to the current time and date. The time and date set here are displayed on the main screen.

- 1 Press the Menu, ▲, or ▼ Button to select the [Settings] menu, and then press the OK Button.
- 2 Select [Set Clock] using ▲ or ▼ Button, and then press the OK Button. The clock setting screen appears.
- 3 Use ▲ or ▼ to specify the last two digits of the year, and then press the OK Button. Specify two digits for the month and day in the same way.
- 4 Use ▲ or ▼ to specify two digits each for the hours and minutes, and then select [AM], [PM] or [24].
- 5 Press the OK Button. The [Settings] menu is displayed.

Note

The format for the time and date can be changed. Select [Administration], and then select [Date Format] or [Time Format] to specify the setting.

LCD (QL-820NWB only)

Screen

When the Label Printer is turned on, the main screen appears.

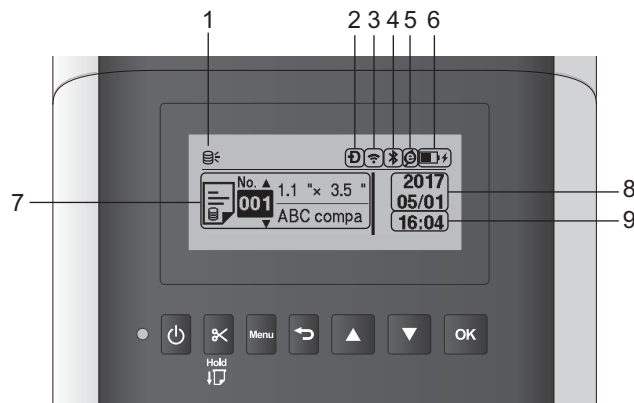

1 Update icon

Indicates whether updated templates, databases, and other data are available.

: There is new data.

(flashing) : Data update failed.

(flashing) : Cannot communicate with the server.

2 Wireless Direct icon

3 WLAN icon



: The network is connected correctly.

: Your Label Printer is searching for the network.

4 Bluetooth icon

: Bluetooth mode

(flashing): Auto Reconnect function is On, and not connected.

5 Eco Charging icon (only appears when Battery Unit is installed)

6 Battery level (only appears when Battery Unit is installed)

Indicates the remaining battery level.

■ Full:

■ Half:

■ Low:

■ Charging:

7 Template

8 Date display

9 Time display



Note

While using the buttons on the Label Printer, do not send prints or change settings from your computer or other devices.

LCD Settings

The settings for the LCD can be specified either by using the Label Printer or by using the **Printer Setting Tool** on a computer connected to the Label Printer. For more information on connecting a computer and specifying settings, see *Changing the Label Printer Settings* on page 37.

Specifying Settings from the Printer

Press the Menu, ▲, or ▼ Button to select a menu option, and then press the OK Button. Press ▲ or ▼ to select an option, and then press the OK Button.

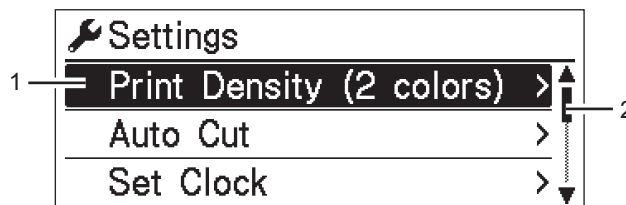

- 1 The currently selected option is highlighted.
- 2 The scroll bar shows the position of the highlighted option on the list.

Using the buttons on the Label Printer, the following settings can be specified:

Menu	Title	Sub title	Settings	Description
Settings	Print Density (2 colors)	Color 1 (Black)	-6 -5 -4 -3 -2 -1 0 +1 +2 +3 +4 +5 +6	Adjust the density of the first color when using 2-color printing.
		Color 2 (Red)	-6 -5 -4 -3 -2 -1 0 +1 +2 +3 +4 +5 +6	Adjust the density of the second color when using 2-color printing.
	Auto Cut		Auto Cut OFF Cut at End	Set the cutting method when printing multiple labels. Auto Cut: Always cuts automatically. OFF: Does not cut automatically. Cut at End: Only cuts at the end, when multiple labels are printed.
	Set Clock		Y (2000-2099) M (1-12) D (1-31) 0-23 (H) 0-59 (M) AM/PM/24	Specify the date and time.

Menu	Title	Sub title	Settings	Description	
Settings (Continued)	Auto Power Off	Adapter	Off 10 20 30 40 50 60	Specify the period of time that passes before the Label Printer turns off automatically when connected to an AC power outlet.	
		Li-ion Battery	Off 10 20 30 40 50 60	Specify the period of time that passes before the Label Printer turns off automatically when powered by the Rechargeable Li-ion Battery.	
	LCD Contrast		-2 -1 0 +1 +2	Set the contrast of the LCD. The higher the number, the stronger the contrast.	
	Backlight			On Off	Switch the backlight On or Off.
		Backlight Timeout		Off 5s 10s 20s 30s 60s	Specify the amount of time of inactivity that passes before the backlight of the LCD turns off automatically.
	Eco Charging			100% 80%	Switch to Eco Charging. If set at 80%, charging will stop automatically when 80% charge is reached.

Menu	Title	Sub title	Settings	Description
Template Settings	Template Mode		On Off	Select whether the template mode starts when the Label Printer is turned on.  Note In the template mode, you can replace the contents of the templates stored in the Label Printer and print them. For further information, see <i>Printing Labels Using P-touch Template</i> on page 69.
	Confirm Print		On Off	Select whether a message appears before printing so that the number of copies can be confirmed.
	Serialize Mode		Cont From Last	Select to serialize from the last number printed.
			From Starting #	Select to serialize from the default number each time you print.
	Serialize Reset		Reset Back	Reset the sequential number to the default number. Select [Back] to return to the previous screen without resetting the number.
	Default Print Quantity		001 999	Specify the default value for the print quantity.
	Preset Template		Show Hide	Select whether or not to display preset templates when using templates other than the factory preset templates.

Menu	Title	Sub title	Settings	Description
Information	Configuration		Printer: QL-820NWB ProgVer: *.* FontVer: *.* Memory: ***/8064kbytes	Display the Label Printer information.
	Print Configuration	All	Start Back	Print the Label Printer set-up information (missing dot test pattern, usage log, printer settings, wireless setting information and transfer data). Select [Back] to return to the previous screen without printing the information.
		Usage Log	Start Back	Print the Label Printer usage log. Select [Back] to return to the previous screen without printing the log.
		Printer Settings	Start Back	Print the Label Printer settings. Select [Back] to return to the previous screen without printing the settings.
		Transfer Data	Start Back	Print the transfer data. Select [Back] to return to the previous screen without printing the transfer data.

Menu	Title	Sub title	Settings	Description
Administration	Command Mode		P-touch Template ESC/P Raster	Select the type of command mode.
	Date Format		1/31/2099 01/31/2099 31/1/2099 31/01/2099 31.1.2099 31.01.2099 31-1-2099 31-01-2099 2099/1/31 2099/01/31 2099-1-31 2099-01-31	Select the date format for the clock.
	Time Format		01:59 (24) 1:59 (24) 1:59AM 01:59AM	Select the time format for the clock.
	 Language		Čeština Dansk Deutsch English Español Français Hrvatski Italiano Magyar Nederlands Norsk Polski Português Română Slovenski Slovenský Suomi Svenska	Select the language of the LCD.
	Unit		inch mm	Select the measurement units for displayed settings.

Menu	Title	Sub title	Settings	Description	
Administration (Continued)	Reset	Factory Reset	Reset Back	Returns all printer settings, including the communication settings and device settings, to their factory defaults. Templates and databases stored in the Label Printer are also deleted.	
		User Data Reset	Reset Back	Returns all device settings to their factory defaults. Templates and databases stored in the Label Printer are also deleted.	
		Network Reset	Reset Back	Returns the communication settings to their factory defaults.	
	Airplane Mode		On Off	If you select [On], the Label Printer is set to Airplane Mode. The following conditions apply: [WLAN] and [Bluetooth] will disappear from the LCD.	
	Menu Locks		Settings Template Settings Information WLAN Bluetooth Feed Remote Update Finish	Select the check boxes for any options you want to prevent changes from the LCD of the Label Printer. After selecting the check boxes, select [Finish] to complete the settings. If the Menu Locks are set, a lock icon is displayed for parameters that cannot be selected.	
	Menu Security			On Off	Select whether a password is required to enter the Administration mode.
				Set Password	If you select [On], specify the 4-digit password.

Menu	Title	Sub title	Settings	Description
WLAN	WLAN (On/Off)		On Off	Select whether to turn the WLAN function On or Off.
	Network Mode		Infrastructure Mode Direct Mode Infra/ Direct Mode	Set which network is used when you select [On] from [WLAN (On/Off)].
	WPS Button Push			Try to connect to wireless access points in the vicinity.
	WPS PIN Code			Display the Label Printer's 8-digit pin code.
	Infra Manual Setting			Display the SSIDs of wireless access points in the vicinity. After you select an SSID and press the OK Button, the password entry screen will appear. Push the Cancel Button several times to return to the previous screen until it is displayed.
	Direct Manual Setting			Manually enter the SSID and password of a wireless access point to connect. Push the Cancel Button several times to return to the previous screen until it is displayed.
	WLAN Status	Infrastructure Mode	Status: **** SSID: **** IP Addr: *.*.*.* NodeName: **** Subnet: *.*.*.* Gateway: *.*.*.* MAC Addr: ****	Display the WLAN status.
	Direct Mode	Status: **** SSID: **** IP Addr: *.*.*.* Password: **** Channel: ****	Display the WLAN status.	
Bluetooth	Bluetooth (On/Off)		On Off	Turn the Bluetooth function on or off.
	Automatic Reconnection		On Off	Switch to Automatic Reconnection mode (only for Apple device : iPad, iPhone, or iPod touch).
	Bluetooth Status		Usage: **** Device: **** Visible: **** Address: ****	Display the status of the Bluetooth function.

Menu	Title	Sub title	Settings	Description
Feed	Feed Start			Determine when the label feed starts. These modes may vary depending on the DK Roll used.
	Die-cut Feed Setting		Current Page	Label feed starts on the current page when the die-cut black mark is detected on the reverse side. If a die-cut black mark is undetected on the current page, this mode feeds to the next page and detection begins from there.
			Next Page	This mode always feeds to the next page and detection begins from there.
Remote Update	Remote Update?		Start Back	Available only when the Label Printer is connected to the FTP Server and when the templates, databases, and other files need to be updated. Press [Start] to begin the remote update. After the update is completed, the Label Printer automatically returns to the main screen.



Note

- Some settings may differ depending on the firmware (printer software).
- If you want to reset the settings, use [Device settings] in the **Printer Setting Tool** to return all settings to their factory defaults. For more information, see *Menu Bar* on page 53.

Setting the Menu Security

When setting the menu security, access to the Administration mode can be restricted by setting a password.

1

- 1 Press the Menu, ▲, or ▼ Button to select the [Administration] menu, and then press the OK Button.
- 2 Select [Menu Security], press ▲ or ▼ to select [On], and then press the OK Button.

Specify the first number using ▲ or ▼, and then press the OK Button to proceed to the next number. Specify the remaining three numbers in the same way.



Note

- After a password has been set, the password input screen appears when the [Administration] menu is selected. Enter the specified 4-digit password using ▲ or ▼, and then press the OK Button.
- To cancel the password settings, select the [Administration] menu and enter the password. Then, select [Menu Security] > [Off].
- If you do not remember the password, use [Device settings] in the **Printer Setting Tool** to return all settings to their factory defaults, or specify the password again and apply it. For more information, see *Menu Bar* on page 53.

Installing the Software and Printer Drivers to a Computer

To print from your Windows computer or Mac, install the printer drivers, P-touch Editor, and other applications to your computer.

For Windows:

Printer Driver, P-touch Editor, P-touch Address Book, P-touch Update Software, Printer Setting Tool, BRAdmin Light and BRAdmin Professional

For Mac:

Printer Driver, P-touch Editor, P-touch Update Software, Printer Setting Tool and Wireless Device Setup Wizard

! Important

QL-810W only: When printing with P-touch Editor, press and hold the P-touch Editor Lite Button until the green Editor Lite LED turns off.

- 1 Visit our website (install.brother) and download the Software Installer for the latest software and manuals.
- 2 Double-click the downloaded EXE file (for Windows) or DMG file (for Mac), and follow the on-screen instructions to proceed with the installation.



Note

To connect the Label Printer to a computer using a wireless connection, we recommend the following:

- Configure the wireless network settings while installing the software. You can change the settings later using the Printer Setting Tool.
- Install the software on a computer wirelessly connected to your network and configure the Label Printer using a USB cable.
- Make a note of the SSID (network name) and password (network key) of the wireless network in advance. If you cannot find this information, ask your network administrator or wireless access point/router manufacturer.
- If your wireless access point/router supports WPS, you can use WPS (Wi-Fi Protected Setup) to quickly configure the wireless network settings.

- 3 Close the dialog box when the installation is complete.

Connecting the Label Printer to a Computer

Refer to these directions for the type or connection method:

- USB cable connection
See *Connecting Using USB* on page 23.
- Wireless LAN connection
See *Connecting Using Wi-Fi* on page 23.
- Bluetooth Connection (QL-820NWB only)
See *Bluetooth Connection (QL-820NWB only)* on page 28.
- Wired LAN connection (QL-820NWB only)
See *Connecting Using a Wired LAN (QL-820NWB only)* on page 28.

Connecting Using USB

- 1 Before connecting the USB Cable, make sure that the Label Printer is turned Off.
- 2 Connect the USB cable to the USB Port on the back of the Label Printer.
- 3 Connect the USB cable to the USB Port on the computer.
- 4 Turn the Label Printer On.

Connecting Using Wi-Fi

The following Wi-Fi connection methods are available:

- Wireless Direct
- Infrastructure Mode
- Infrastructure Mode + Wireless Direct
- WPS (Wi-Fi Protected Setup™)

Wireless Direct

Wireless Direct allows you to connect the Label Printer to your computer or mobile device directly without a Wi-Fi access point/router; the printer serves as a Wi-Fi access point.

- 1 Confirm the Wireless Direct settings of the Label Printer.
 - Using the Label Printer (QL-820NWB only)
 - 1 Press the Menu and ▼ Buttons to select the [WLAN] menu, and then press the OK Button. Set [WLAN (On/Off)] to [On].
 - 2 Press the Menu and ▼ Buttons to select the [WLAN] menu, and then press the OK Button.
 - 3 Press the ▼ Button to select the [Network Mode] menu, and then press the OK Button.

4 Select [Direct Mode], and then press the OK Button. The Wireless Direct icon appears on the LCD.

■ For Windows

Connect the Label Printer and computer with a USB cable. Start the Printer Setting Tool on your computer, and click [Communication Settings]. Select [Infrastructure and Wireless Direct] or [Wireless Direct] for [Selected Interface] in [Communication Settings] in the [General] tab, and confirm the [Wireless Direct] tab.

For more information, see *Communication Settings for Windows* on page 40.

■ For Mac

Start the Printer Setting Tool on your computer, and select [On] for [Wireless Direct] in the [Wireless LAN] tab.

2 Use your computer to select the SSID of the Label Printer ("DIRECT-*****_QL-810W" or "DIRECT-*****_QL-820NWB" where ***** is the last five digits of the product serial number). If required, enter the password (810*****/820***** where ***** is the last five digits of the product serial number).

 **Note**

- You can change the Label Printer's network settings using the Printer Setting Tool. For more information, see *Wireless Settings* on page 46.
- The Printer Setting Tool also allows you to apply the network settings changes to multiple Label Printers. For more information, see *Applying Setting Changes to Multiple Printers* on page 50.
- You can find the serial number label in the DK Roll Compartment of the Label Printer.
- You cannot connect to the Internet on your computer via Wi-Fi while using Wireless Direct.
- The SSID can also be entered using the LCD. Select the SSID from the displayed list, or press the ▼ Button to select the [Direct Manual setting], and then manually enter the SSID and password. Push the Cancel Button several times to return to the previous screen until it is displayed.

Infrastructure Mode

Infrastructure Mode allows you to connect the Label Printer to a computer via a Wi-Fi access point/router.

■ **Before You Begin**

First, you must configure the Wi-Fi settings of the Label Printer to communicate with your Wi-Fi access point/router. After the Label Printer is configured, computers on your network will have access to the Label Printer.

❗ **Important**

- If you are going to connect the Label Printer to your network, we recommend that you contact your system administrator before installation. You must confirm your Wi-Fi settings before you proceed with this installation.
- To configure the Wi-Fi settings again, or if the status of the Wi-Fi connection for the Label Printer is unknown, reset the Wi-Fi settings of the Label Printer.

For QL-810W

1 Press and hold the Power (⏻) Button to turn the Label Printer off.

- 2 Press and hold the Cutter (✂) Button and the Power (⏻) Button for about one second. The Status LED starts blinking in green.
- 3 The Status LED is lit in orange, the Editor Lite LED flashes in green and the Wi-Fi LED flashes in blue. While pressing the Power (⏻) Button, press the Cutter (✂) Button once and the Status LED lights in orange.
- 4 Release the Power (⏻) Button. Then the Status LED is lit in orange, the Editor Lite LED flashes in green and the Wi-Fi LED flashes in blue. The Wi-Fi settings of the printer is reset.

For QL-820NWB

Select [Network Reset] from the menu.

For more information, see *LCD Settings* on page 12.

Note

- We recommend making a note of the SSID (network name) and password (network key) of the wireless network in advance.
- To achieve the best results with normal everyday document printing, use the Label Printer as close to the Wi-Fi access point/router as possible with minimal obstructions. Large objects and walls between the two devices as well as interference from other electronic devices can affect communication, or the data transfer speed of your documents.

■ Connecting the Label Printer to your Wi-Fi access point/router

- 1 First, write down the SSID (network name) and password (network key) of your Wi-Fi access point/router.
- 2 Connect the Label Printer and computer with a USB cable.
- 3 Configure the Infrastructure Mode settings of the Label Printer.
 - Using the Label Printer (QL-820NWB only)
 - 1 Press the Menu and ▼ Buttons to select the [WLAN] menu, and then press the OK Button.
 - 2 Press the ▼ Button to select the [Network Mode] menu, and then press the OK Button.
 - 3 Select [Infrastructure Mode], and then press the OK Button.

Note

The SSID can also be entered using the LCD. Press the Menu and ▼ Buttons to select the [WLAN] menu, and then press the OK Button. Press the ▼ Button to select the [Infra Manual Setting]. Push the Cancel Button several times to return to the previous screen until it is displayed.

■ For Windows

- 1 Start the Printer Setting Tool on your computer, and click [Communication Settings]. Select [Infrastructure or Ad-hoc] or [Infrastructure and Wireless Direct] for [Selected Interface] in [Communication Settings] in the [General] tab, and select [Infrastructure] for [Communication Mode] in [Wireless Settings] in the [Wireless LAN] tab.

- 2 Enter the SSID that you wrote down, or click [**Search**] and select the SSID from the displayed list, and enter the password (network key) of your Wi-Fi access point/router.
- 3 Click [**Apply**].

For more information, see *Communication Settings for Windows* on page 40.

■ For Mac

Start the Wireless Device Setup Wizard included in the Printer Driver Package, and then follow the on-screen instructions. The Wireless Device Setup Wizard can be found in the [**Utilities**] folder.

- 4 **For QL-810W**
Press and hold the Wi-Fi (📶) Button for one second.

For QL-820NWB

Press the Menu and ▼ Buttons to select the [WLAN] menu, and then press the OK Button. Set [WLAN (On/Off)] to [On].

- 5 When the connection between the Label Printer and your Wi-Fi access point/router is established, the Wi-Fi (📶) LED starts flashing in blue (QL-810W) or [Connected!] appears on the LCD (QL-820NWB). Computers and mobile devices that are on the same network as the Label Printer will have access to the Label Printer.



Note

To change any other network settings, use the Printer Setting Tool. For more information, see *Changing the Label Printer Settings* on page 37.

Infrastructure Mode + Wireless Direct

Infrastructure Mode and Wireless Direct can be used at the same time.

- 1 Set the Label Printer to Infrastructure/Direct Mode.
 - Using the Label Printer
 - 1 Press the Menu and ▼ Buttons to select the [WLAN] menu, and then press the OK Button.
 - 2 Press the ▼ Button to select the [Network Mode] menu, and then press the OK Button.
 - 3 Select [Infra/Direct Mode], and then press the OK Button.
 - For computers
 - 1 Start the Printer Setting Tool on your computer, and click the [**Communication Settings**] button.
 - 2 Select [**Infrastructure and WirelessDirect**] for [**Selected Interface**] in the [**General**] tab.
For more information on the Communication Settings, see *General Tab* on page 44.
- 2 For QL-820NWB, press the Menu and ▼ Buttons to select the [WLAN] menu, and then press the OK Button.
Set [WLAN (On/Off)] to [On].

For QL-810W, press and hold the Wi-Fi (📶) Button.

- 3 To use the computer or mobile device to select the SSID of the Label Printer, see step 2 of *Wireless Direct* on page 24.
To configure the Infrastructure Mode settings of the Label Printer, see step 3 of *Connecting the Label Printer to your Wi-Fi access point/router* on page 25.

WPS (Wi-Fi Protected Setup™)

If your Wi-Fi access point/router supports WPS, settings and connections can be configured quickly.

- 1 First, confirm that your Wi-Fi access point/router has the WPS symbol.



- 2 Place the Label Printer within the range of your Wi-Fi access point/router. The range may differ depending on your environment. See the instructions provided with your Wi-Fi access point/router.
- 3 On the Label Printer:
 - **For QL-810W**
Press and hold the WPS Button for one second.
When the connection is established, The Wi-Fi (📶) LED is lit blue.
 - **For QL-820NWB**
 - a). Press the Menu and ▼ Buttons to select [WLAN] menu, and then press the OK Button.
 - b). Press the ▼ Button to select the [WPS Button Push] menu, and then press the OK Button.
When the connection is established, the WLAN icon appears on the Label Printer LCD.

Note

- Computers and mobile devices that are on the same network as the Label Printer will have access to the Label Printer.
- The Label Printer will try to connect using WPS for two minutes. If the WPS Button (QL-810W) or OK Button (QL-820NWB) is pressed during that time, the Label Printer will continue trying to connect for an additional two minutes.
- You can also configure this using the PIN code.

Connecting Using a Wired LAN (QL-820NWB only)



Note

To use a static IP address to connect your Label Printer to a wired LAN connection, install the printer drivers and Printer Setting Tool, and then specify the wired LAN connection settings.

For more information, see *Installing the Software and Printer Drivers to a Computer* on page 22.

- 1 Unless wireless LAN is turned off, a wired LAN cannot be used. Turn off wireless LAN using the Printer Setting Tool before connecting the Label Printer to a wired LAN connection.
- 2 Turn off the Label Printer before connecting the LAN cable.
- 3 Connect the LAN cable to the LAN Port on the back of the Label Printer.
- 4 Connect the LAN cable to an active LAN Port on the network.
- 5 Turn the Label Printer On.



Note

The Label Printer's communication settings can be changed under [**Communication Settings**] in the Printer Setting Tool. For more information on the Communication Settings, see *General Tab* on page 44.

Network Cable

Use a straight-through Category 5 (or greater) twisted-pair cable for 10BASE-T or 100BASE-TX Fast Ethernet Network.



Note

Do not connect this product to any LAN connection that is subject to overvoltages.

Bluetooth Connection (QL-820NWB only)

Important

In order for the Label Printer and your Bluetooth-equipped computer or adapter to communicate, you must first pair the Label Printer with the computer or mobile device using the Bluetooth management software using your computer or mobile device.

- 1 Press the Menu Button.
- 2 Press the ▲ or ▼ Button to select the [Bluetooth] menu.
- 3 Press the OK Button.
- 4 Press the ▲ or ▼ Button to select [Bluetooth(On/Off)], then press OK Button. Press the ▲ or ▼ Button to select [On], then press OK Button.
- 5 Use your Bluetooth management software to discover the Label Printer. Bluetooth communication is now available.

Connecting the Label Printer to a Barcode Scanner using Bluetooth (QL-820NWB only)

You can connect the Label Printer to a Barcode Scanner using a Bluetooth interface.



Note

- Follow the recommendations of the manufacturer of your Bluetooth-equipped devices, such as Barcode Scanners, and install any necessary hardware and software.
- The Bluetooth connection settings are saved even after the Label Printer is turned off.

■ Connecting the Label Printer to a Barcode Scanner using Bluetooth

To print barcodes using a Bluetooth connection you must perform the following steps:

Once a connection has been established, the Label Printer remains connected until it is turned off, preventing it from connecting to another device.

- 1 Press the Menu and ▼ Button to select the [Bluetooth] menu, and then press the OK Button. Set [Bluetooth (On/Off)] to [On].

For Bluetooth Version 2.0 or earlier

- 2 Check the PIN code in the Bluetooth tab in the settings dialog box in the Printer Setting Tools, and enter it into your destination Bluetooth device.

For Bluetooth Version 2.1 or later

- 2 Execute pairing from a destination Bluetooth device.
- 3 When the [Request Secure Simple Pairing (SSP) settings during pairing] check box is not selected, a Bluetooth Pass Key for a Bluetooth device (of destination) is displayed on the LCD and the Bluetooth connection is made.

When [Request Secure Simple Pairing (SSP) settings during pairing] check box is selected, a Bluetooth Pass Key is displayed on the LCD. Press OK Button on the Label Printer. As the displayed Bluetooth Pass Key is entered to the Bluetooth device (of destination), the Bluetooth connection is made.

Printing from a Computer

Available Applications

To use the Label Printer effectively, a number of applications and functions are available.

You must install the printer driver to use these applications.

Visit our website (install.brother) and download the installer for the applications and printer driver.

Application	Windows	Mac	Features
P-touch Editor	✓	✓	Designs and prints custom labels with built-in drawing tools, text using different fonts and styles, imported graphic images and barcodes.
P-touch Transfer Manager	✓		Allows you to transfer templates and other data to the Label Printer and save backups of your data on the computer. This application is installed with P-touch Editor.
P-touch Library	✓		Manages and prints P-touch Editor templates. You can use P-touch Library to print templates. This application is installed with P-touch Editor.
P-touch Update Software	✓	✓	Updates software to the latest version.
P-touch Address Book	✓		Prints address labels using an address database.
P-touch Editor Lite LAN	✓		Prints over wireless as well as wired connections.
Printer Setting Tool	✓	✓	Specifies the Label Printer's device settings from a computer.
Wireless Device Setup Wizard		✓	Allows you to configure the Label Printer for a wireless network.
BRAdmin Light	✓		Finds the Label Printer on your network and allows you to configure basic settings from your computer.
BRAdmin Professional	✓		Finds the Label Printer on your network and allows you to configure advanced settings and updates from your computer.

Function	Windows	Mac	Features
Distributed printing	✓		When printing a large number of labels, printing can be distributed among multiple Label Printers. Because printing is performed at the same time, the total printing time can be reduced. For more information, see <i>Distributed Printing (Windows only)</i> on page 92.

Creating Labels from Your Computer

There are various methods for printing with this Label Printer.



The following describes the procedure for printing from a computer using P-touch Editor or P-touch Address Book.

- 1 Start P-touch Editor or P-touch Address Book, and then open the document you want to print.
- 2 Create a label design.
- 3 Check the cutting options.
- 4 Select **[File]** and then select **[Print]** from the menu bar or click the **[Print]** icon.

Cutting Options

The cutting options allow you to specify how the item is fed and cut when it is printed. Use the printer driver to select the cutting option when printing from the computer.

Label Cut Option Table

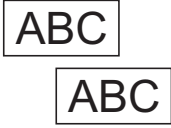
Auto Cut	Cut at end	Image
No	Yes	
No	No	
Yes	Yes or No	

Attaching Labels

- 1 Peel the backing from the label.
- 2 Position the label, and then press firmly from top to bottom with your finger to attach the label.



Note

Labels may be difficult to attach to surfaces that are wet, dirty, or uneven. The labels may peel off easily from these surfaces.

Installing Applications for Use with Mobile Devices

Brother offers various applications for use with your Label Printer, including applications that allow you to print directly from your Apple iPhone, iPad, and iPod touch or Android™ smartphone or tablet, and applications that allow you to transfer data wirelessly, such as templates, symbols, and databases created using a computer, to your Label Printer.

Available Applications

The following free Brother applications can be downloaded from the App Store or Google Play™:

Application	Features
Brother iPrint&Label	Create and print labels using templates on a smartphone, tablet or other mobile device directly to your Label Printer.
Mobile Transfer Express	Allows you to use a mobile device to download databases and label data, created on a computer using P-touch Editor and saved to a cloud service, and send them to your Label Printer.



Note

You can also connect your printer and Android mobile device using a USB On-the-Go cable (purchased separately).

Connecting the Label Printer to a Mobile Device

- 1 Confirm the Wireless Direct settings of the Label Printer, and then connect the Label Printer to your computer using a USB cable.
 - Using the Label Printer (QL-820NWB only)
 - 1 Press the Menu and ▼ Buttons to select the [WLAN] menu, and then press the OK Button. Set [WLAN (On/Off)] to [On].
 - 2 Press the Menu and ▼ Buttons to select the [WLAN] menu, and then press the OK Button.
 - 3 Press the ▼ Button to select the [Network Mode] menu, and then press the OK Button.
 - 4 Select [Direct Mode], and then press the OK Button. The Wireless Direct icon appears on the LCD.
 - For Windows

Connect the Label Printer and computer with a USB cable. Start the Printer Setting Tool on your computer, and click **[Communication Settings]**. Select **[Infrastructure and Wireless Direct]** or **[Wireless Direct]** for **[Selected Interface]** in **[Communication Settings]** in the **[General]** tab, and confirm the **[Wireless Direct]** tab.

See *Communication Settings for Windows* on page 40 for more information on the Communication Settings.

- For Mac
 - a) Launch the **Printer Setting Tool** on your computer.
 - b) Click the [**Wireless LAN**] tab.
 - c) Confirm that [**Wireless Direct**] is set to [**On**].

2 For QL-810W

Press and hold the Wi-Fi (📶) Button on the Label Printer for one second to turn the Wi-Fi function On. The Wi-Fi (📶) LED starts flashing blue once every three seconds.

For QL-820NWB

Press the Menu and ▼ Buttons to select the [WLAN] menu, and then press the OK Button.

Set [WLAN (On/Off)] to [On] to turn the Wi-Fi function On. The Wi-Fi (📶) icon appears on the LCD.

- 3** In the Wi-Fi settings screen of your mobile device, select the SSID of the Label Printer and enter the password.



Note

- The factory default SSID and password are as follows:
SSID: "DIRECT-*****_QL-810W" or "DIRECT-*****_QL-820NWB" where ***** is the last five digits of the product serial number.
(You can find the product serial number label in the DK Roll Compartment of the Label Printer.)
The password: 810*****/820***** where ***** is the last five digits of the product serial number.
- You can connect the Label Printer to a mobile device in the Infrastructure Mode via a wireless access point/router.

Printing from a Mobile Device

- 1 Make sure that the Label Printer is connected to your mobile device. Start the mobile printing application on your mobile device. See *Connecting the Label Printer to a Mobile Device* on page 33.
- 2 Select a label template or design. You can also select a previously designed label or image and print it.
- 3 Tap [Print] in the application menu.

Cutting Options

See *Cutting Options* on page 31.

Using a Mobile Device to Print Templates Created on a Computer

You can use P-touch Transfer Manager to save template data, which was created using P-touch Editor, in the BLF or PDZ format. Then, you can use Mobile Transfer Express to send the saved file from your mobile device to the Label Printer and print the file.

- 1 Save the template data in the BLF format or the PDZ format using P-touch Transfer Manager. For more information, see *Creating Transfer Files and Transfer Package Files* on page 133.
- 2 Use one of the following methods to use a .blf file or .pdz file with your mobile device.
 - Save the file using a cloud storage service, and then use the sharing function of the mobile device's operating system to share the file.
 - Send the file as an email attachment from the computer to the mobile device, and then save the file to the mobile device.
- 3 Connect the Label Printer to your mobile device, and then start Mobile Transfer Express. The template data appears.
- 4 Select the template that you want to print, and then transfer the template to the Label Printer.



Note

To download a file from a cloud storage service to your mobile device, you must connect your mobile device using Infrastructure Mode. Therefore, if you also connect your mobile device to the Label Printer using Infrastructure Mode, you can quickly transfer downloaded files (.blf files only).

- 5 Use the Barcode Scanner or the LCD (QL-820NWB only) to select the template that you want to print from the transferred file and print it.

Attaching Labels

- 1 Peel the backing from the label.
- 2 Position the label, and then press firmly from top to bottom with your finger to attach the label.



Note

Labels may be difficult to attach to surfaces that are wet, dirty, or uneven. The labels may peel off easily from these surfaces.

Printer Setting Tool for Windows

Use the Printer Setting Tool to specify the Label Printer's communication settings, device settings and P-touch Template settings from a Windows computer.



Note

The Printer Setting Tool is installed automatically when you use the initial installer to install the printer driver. For more information, see *Installing the Software and Printer Drivers to a Computer* on page 22.



Important

The Printer Setting Tool is available only with compatible Brother printers.

Before Using the Printer Setting Tool

- Make sure the AC Adapter is connected to the Label Printer and to an AC power outlet, or a fully-charged battery is installed.
- Make sure the printer driver has been installed correctly and you can print.
- Connect this Label Printer to a computer with a USB cable.

Using the Printer Setting Tool for Windows

- 1 Connect the Label Printer you want to configure to the computer.
- 2 Start the Printer Setting Tool.
 - **For Windows Vista / Windows 7 / Windows Server 2008 / Windows Server 2008 R2:**
Click **Start > All Programs > Brother > Labels & Mobile Printer > Printer Setting Tool.**
 - **For Windows 8 / Windows 8.1 / Windows Server 2012 / Windows Server 2012 R2:**
On the **Apps** screen, click the **Printer Setting Tool.**
 - **For Windows 10:**
Click **Start > Brother > Label & Mobile Printer > Printer Setting Tool.**
The main window appears.

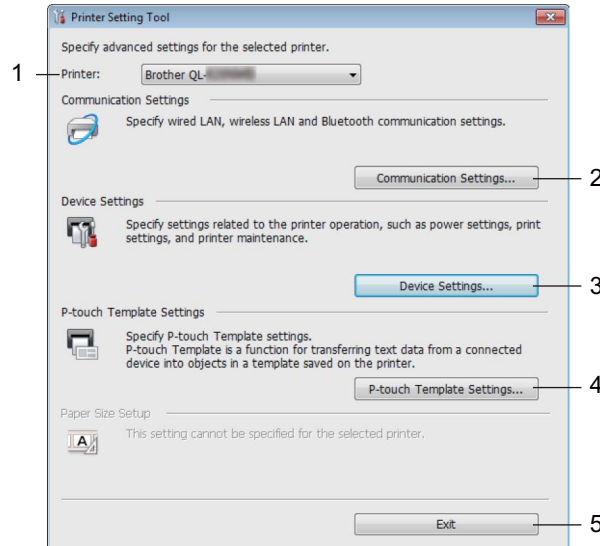

1 Printer

Lists the connected Label Printers.

2 Communication Settings

Specifies wired LAN (QL-820NWB only), wireless LAN and Bluetooth (QL-820NWB only) communication settings.

3 Device Settings

Specifies printer device settings, such as power settings and printer settings.

4 P-touch Template Settings

Specifies P-touch Template settings.

For more information on P-touch Template, download the *P-touch Template Manual/Command Reference* (English only)

5 Exit

Closes the window.

- 3 Check that the Label Printer you want to configure appears next to **[Printer]**. If a different Label Printer appears, select the Label Printer you want from the drop-down list.



Note

If only one Label Printer is connected, it is unnecessary to make a selection because only that Label Printer is available.

- 4 Select the settings you want to change, and then specify or change the settings in the dialog box. For more information on the settings dialog boxes, see *Communication Settings for Windows* on page 40, *Device Settings for Windows* on page 51 or *P-touch Template Settings for Windows* on page 59.
- 5 Click **[Apply]**, and then click **[Exit...]** to apply the settings to the Label Printer.
- 6 Click **[Exit]** in the main window to finish specifying settings.

Important

Use the Printer Setting Tool to configure the Label Printer *only* when the Label Printer is waiting for the next print job. The Label Printer may malfunction if you try to configure it while it is handling a job.

Communication Settings for Windows

Use [Communication Settings] in the Printer Setting Tool to specify or change the Label Printer communication information when connecting the Label Printer and computer with a USB cable or via a Bluetooth connection (QL-820NWB only). Not only can you change the communication settings for one Label Printer, but you can also apply the same settings to multiple Label Printer.

Settings Dialog Box

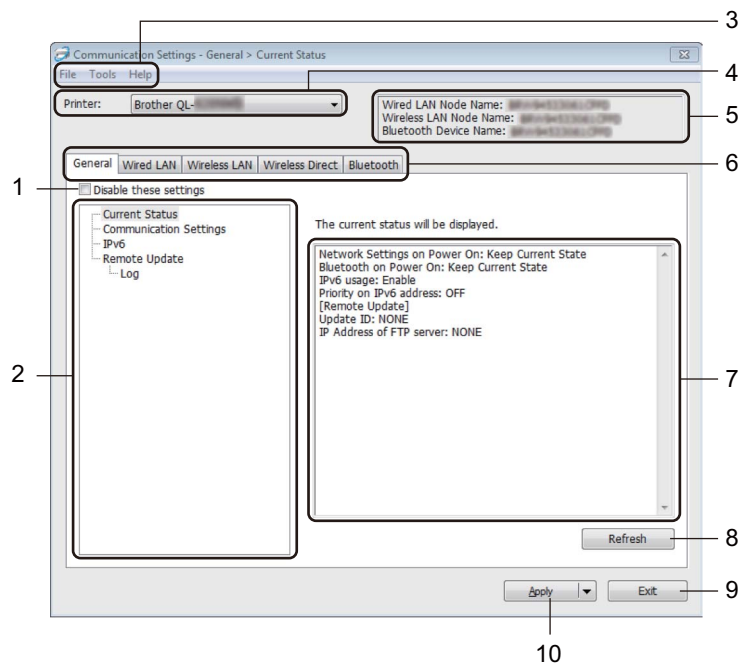

1 Disable these settings

When this check box is selected,  appears in the tab, and the settings can no longer be specified or changed.

Settings in a tab where  appears will not be applied to the Label Printer even if [Apply] is clicked. In addition, the settings in the tab will not be saved or exported when the [Save in Command File] or [Export] command is used.

To apply the settings to the Label Printer, or to save or export them, make sure you clear the check box.

2 Items

When [Current Status] is selected, the current settings appear in the settings display/change area. Select the item for the settings that you want to change.

3 Menu Bar

Commands are categorized under each menu (File, Tools and Help) by function.

4 Printer

Lists the connected Label Printers.

5 Node Name

Displays the node name (nodes can be renamed). For more information, see *Menu Bar* on page 42.

6 Settings Tabs

Contains settings that may be specified or changed.

If  appears in the tab, the settings in that tab will not be applied to the Label Printer.

7 Settings Display/Change Area

Displays the current settings for the selected item.

8 Refresh

Updates the displayed settings with the most recent information.

9 Exit

Exits [**Communication Settings**], and returns to the main window of the Printer Setting Tool.

! Important

Settings are not applied to Label Printers if [**Exit**] is clicked without clicking the [**Apply**] button after changing the settings.

10 Apply

Applies the settings to the Label Printer.

To save the specified settings in a command file, select [**Save in Command File**] from the drop-down list. The saved command file can be used with the mass storage mode to apply the settings to a Label Printer. For more information, see *Mass Storage Mode (QL-820NWB only)* on page 86.

! Important

Clicking [**Apply**] applies all settings in all tabs to the Label Printer.

If the [**Disable these settings**] check box is selected, the settings in that tab are not applied.

Menu Bar

The following explains about the menu items in the settings dialog box.

- **Apply Settings to the Printer**
Applies the settings to the Label Printer.
- **Save Settings in Command File**
Saves the specified settings in a command file. The file extension is .bin.
The saved command file can be used with the mass storage mode to apply the settings to a Label Printer.
For more information, see *Mass Storage Mode (QL-820NWB only)* on page 86.



Note

If the [**Disable these settings**] check box is selected, the settings in that tab are not saved.

Important

- The following information is not saved with the command file:
 - Node name
 - IP address, subnet mask and default gateway (when the IP address is set to [**STATIC**])
 - The saved communication settings commands are intended to be used only for applying settings to a Label Printer. To apply the settings to the Label Printer using this command file, use the mass storage mode.
 - Saved command files contain authentication keys and passwords. Take necessary measures to protect saved command files, such as saving them in a location that cannot be accessed by other users.
 - Do not send command files to a different printer model.
-

Import

■ Import from the current computer wireless settings

Imports the settings from the computer.



Note

- When importing the computer's wireless settings, administrator privileges for the computer are needed.
 - Only personal security authentication settings (open system, public key authentication and WPA/WPA2-PSK) can be imported. Enterprise security authentication (such as LEAP and EAP-FAST), WPA2-PSK (TKIP) and WPA-PSK (AES) settings cannot be imported.
 - If multiple wireless LANs are enabled for the computer you use, the first wireless settings (only personal settings) that are detected will be considered for the import data.
 - Only the settings (communication mode, SSID, authentication method, encryption mode and authentication key) from the [**Wireless LAN**] tab - [**Wireless Settings**] pane can be imported.
-

■ Select a Profile to import

Imports the exported file and applies the settings to a Label Printer.

Click [**Browse**] and select the file you want to import. The settings in the selected file appear in the settings display/change area.



Note

- All settings, such as wireless settings or TCP/IP settings, can be imported, except for node names.
- Only profiles that are compatible with the selected Label Printer can be imported.
- If the imported profile's IP address is set to **[STATIC]**, change the IP address of the imported profile, if needed, so that it does not duplicate the IP address of an existing configured Label Printer on the network.

• Export

Saves the current settings in a file.

If the **[Disable these settings]** check box is selected the settings in that tab are not saved.



Important

Exported files are not encrypted.

• Automatically restart the Label Printer after applying new settings

If this check box is selected, the Label Printer automatically restarts after communication settings are applied.

If this check box is cleared, you must restart the Label Printer manually.



Note

When configuring multiple Label Printer's, you can reduce the time needed to change settings by clearing this check box. In this case, we recommend selecting this check box when configuring the first Label Printer so that you can confirm that each setting is operating as intended.

• Automatically detects the connected Label Printer, and retrieves the current settings

If this check box is selected and a Label Printer is connected to the computer, the Label Printer is automatically detected and the Label Printer's current settings are displayed in the **[Current Status]** pane.



Note

If the model of the connected Label Printer is different from that of the Label Printer shown in the **[Printer]** drop-down list, the settings available on all tabs change to match the connected Label Printer.

• Change Node Name/Bluetooth Device Name

Allows renaming a node.

• Reset to Default Communication Settings

Returns the communication settings to their factory settings.

• Display Help

Displays the Help topics.

General Tab

The following explains about the General Tab in the settings dialog box.

Communication Settings

- **Network Settings on Power On**
Specifies the conditions for connecting via Wi-Fi when the Label Printer is turned on.
QL-810W: Select [**On by Default**], [**Off by Default**] or [**Keep Current State**].
QL-820NWB: Select [**Wireless LAN by Default**], [**Wired LAN by Default**] or [**Keep Current State**].
- **Selected Interface**
Selects [**Infrastructure or Ad-hoc**], [**Infrastructure and Wireless Direct**] or [**Wireless Direct**].
- **Bluetooth on Power On (QL-820NWB only)**
Specifies the conditions for connecting via Bluetooth when the Label Printer is turned on.
Select [**On by Default**], [**Off by Default**] or [**Keep Current State**].

IPv6

- **IPv6 usage**
Selects [**Enable**] or [**Disable**].
- **Priority on IPv6 address**
Selects to give priority to an IPv6 address.

Remote Update (QL-820NWB only)

Remote Update is a Label Printer feature that enables the semi-automatic update of the Label Printer's settings with a simple connection to an FTP server where the update files are saved.

- **IP Address of FTP server**
Types the FTP server address.
- **Port**
Specifies the port number used to access the FTP server.
- **PASV Mode**
Set the PASV Mode to on or off.
- **User name**
Enters a user name that has permission to login to the FTP server.
- **Password**
Enters the password associated with the user name you entered in the Username field.
- **Display the key and password on-screen**
- **Path**
Enters the path to the folder on the FTP server where you want to download the update file from.
- **Setting file name**
Specifies the update file name on the FTP server.

Log (QL-820NWB only)

- **Log storage**
Selects whether to export the update log to the FTP server.
- **Log storage path of FTP server**
Enters the path to the folder on the FTP server where you want to export the log data.

Wired LAN (QL-820NWB only) / Wireless LAN Tabs

The following explains about the Wired LAN (QL-820NWB only) and Wireless Tab in the settings dialog box.

TCP/IP (Wired/Wireless)

- **Boot Method**
Selects [AUTO], [BOOTP], [DHCP], [RARP], or [STATIC].
- **IP Address/Subnet Mask/Gateway**
Specifies the various networking values.
You can enter these settings only when the IP address is set to [STATIC].
- **DNS Server Method**
Selects [AUTO] or [STATIC].
- **Primary DNS Server IP Address/Secondary DNS Server IP Address**
You can enter these settings only when the DNS server is set to [STATIC].

IPv6

- **Static IPv6 Address**
Specifies a permanent IPv6 address.
- **Enable this address**
Enables the specified static IPv6 address.
- **Primary DNS Server IPv6 Address/Secondary DNS Server IPv6 Address**
Specifies the DNS server IPv6 addresses.
- **IPv6 Address List**
Displays the list of IPv6 addresses.

Wireless Settings

- **Communication Mode**
Selects [Infrastructure] or [Ad-hoc].
- **SSID (Network Name)**
Clicking [Search] displays the available SSID selections in a separate dialog box.
- **Channel**
Lists available channels.



Note

This setting is valid only in Ad-Hoc mode.

- **Authentication Method/Encryption Mode**
The supported encryption modes for the authentication methods are as shown in *Communication Modes and Authentication Methods/Encryption Modes* on page 47.
- **WEP Key**
You can specify a setting only when WEP is selected as the encryption mode.
- **Passphrase**
You can specify a setting only when WPA/WPA2-PSK is selected as the authentication method.

- **User ID/Password**

You can specify settings only when LEAP, EAP-FAST, PEAP, EAP-TTLS or EAP-TLS is selected as the authentication method. In addition, with EAP-TLS, it is not necessary to register a password, but a client certificate must be registered. To register a certificate, connect to the Label Printer from a web browser, and then specify the certificate. For more information on using a web browser, see *Web Based Management* on page 160.

- **Display the key and password on-screen**

If this check box is selected, keys and passwords are displayed in plain (non-encrypted) text.

Communication Modes and Authentication Methods/Encryption Modes

■ When [Communication Mode] is set to [Ad-hoc]

Authentication Method	Encryption Mode
Open System	None / WEP

■ When [Communication Mode] is set to [Infrastructure]

Authentication Method	Encryption Mode
Open System	None / WEP
Shared Key	WEP
WPA/WPA2-PSK	TKIP+AES / AES
LEAP	CKIP
EAP-FAST/NONE	TKIP+AES / AES
EAP-FAST/MS-CHAPv2	TKIP+AES / AES
EAP-FAST/GTC	TKIP+AES / AES
PEAP/MS-CHAPv2	TKIP+AES / AES
PEAP/GTC	TKIP+AES / AES
EAP-TTLS/CHAP	TKIP+AES / AES
EAP-TTLS/MS-CHAP	TKIP+AES / AES
EAP-TTLS/MS-CHAPv2	TKIP+AES / AES
EAP-TTLS/PAP	TKIP+AES / AES
EAP-TLS	TKIP+AES / AES

! Important

To specify higher level security settings:

When performing certificate verification with EAP-FAST, PEAP, EAP-TTLS or EAP-TLS authentication methods, the certificate cannot be specified from the Printer Setting Tool. After the Label Printer is configured to connect to the network, specify the certificate by accessing the Label Printer from a web browser.

For more information on using a web browser, see *Web Based Management* on page 160.

Wireless Direct Tab

The following explains about the Wireless Direct Tab in the settings dialog box.

Wireless Direct Settings

- **SSID/Network Key Generation**
Select [AUTO] or [STATIC].
- **SSID (Network Name)/Network Key**
Specifies the SSID (25 ASCII characters or fewer) and the network key (63 characters or fewer) you want to use in the Wireless Direct mode.



Note

The factory settings for the SSID and password are as follows:

SSID: "DIRECT-*****_QL-810W" or "DIRECT-*****_QL-820NWB" where "*****" is the last five digits of the product serial number.

(You can find the product serial number label in the DK Roll Compartment of the Label Printer.)

The password: 810*****/820***** where ***** is the last five digits of the product serial number.

- **Channel**
Specifies the channel to use for the Wireless Direct mode.

Bluetooth Tab (QL-820NWB only)

The following explains about the Bluetooth Tab in the settings dialog box.

Bluetooth Settings

- **Visible to Other Devices**

Allows the Label Printer to be “discovered” by other Bluetooth devices.

Available settings: [**Discoverable**], [**Not Discoverable**]

- **Change PIN code**

If this check box is selected, you can change the PIN.

- **PIN code**

Specifies the PIN that will be used when pairing with devices compliant with Bluetooth 2.0 or earlier.

- **Display the PIN code on-screen**

If this check box is selected, your computer displays the PIN by default.

- **Request Secure Simple Pairing (SSP) settings during pairing**

If this check box is selected, pairing can be performed using the Label Printer buttons for devices that are compliant with Bluetooth 2.1 or later.

Auto Reconnect

- **Auto re-pairing**

Sets whether or not to automatically reconnect to previously connected Apple device (iPad, iPhone or iPod touch).

Available settings: [**Enable**], [**Disable**]

Applying Setting Changes to Multiple Printers

- 1 After applying settings to the first Label Printer, disconnect the Label Printer from the computer, and then connect the second Label Printer to the computer.
- 2 Select the newly connected Label Printer from the **[Printer]** drop-down list.

 **Note**

If the **[Automatically detects the connected Label Printer, and retrieves the current settings]** check box in the **Option Setting** dialog box is selected, the Label Printer connected with the USB cable is automatically selected. For more information, see *Communication Settings for Windows* on page 40.

- 3 Click **[Apply]**.
The same settings that were applied to the first Label Printer are applied to the second Label Printer.

 **Note**

We recommend selecting the **[Automatically restart the Label Printer after applying new settings]** check box when configuring the first Label Printer so that you can confirm that a connection with the wireless access point/router can be correctly established with the settings. For more information, see *Communication Settings for Windows* on page 40.

- 4 Repeat steps 1 – 3 for all Label Printers whose settings you want to change.

 **Important**

If the IP address is set to **[STATIC]**, the Label Printer's IP address will also be changed to the same address as the first Label Printer. Change the IP address if needed.

 **Note**

To save the current settings in a file, click **[File] - [Export]**.

The same settings can be applied to another Label Printer by clicking **[File] - [Import]**, then selecting the exported settings file. For further information, see *Communication Settings for Windows* on page 40.

Device Settings for Windows

Use **[Device Settings]** in the Printer Setting Tool to specify or change printer settings when connecting the Label Printer and computer with a USB cable or via a Bluetooth connection. Not only can you change the device settings for one Label Printer, but you can also apply the same settings to multiple Label Printer.

When printing from a computer application, various printing settings can be specified from the printer driver; however, by using **[Device Settings]** in the Printer Setting Tool, more advanced settings can be specified.

When **[Device Settings]** is opened, the Label Printer's current settings are retrieved and displayed. If the current settings could not be retrieved, the previous settings are displayed. If the current settings could not be retrieved and previous settings have not been specified, the machine's factory settings are displayed.

Settings Dialog Box

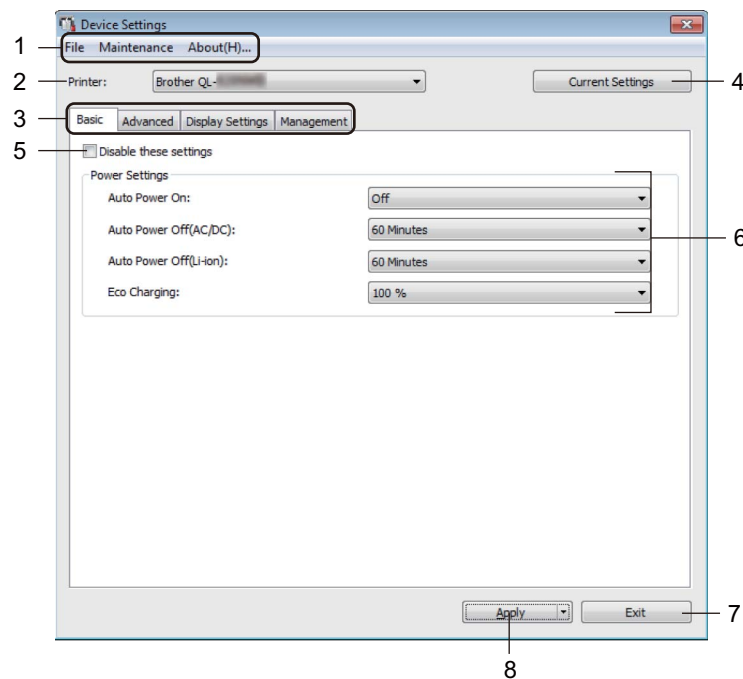

1 Menu Bar

Selects a command contained in each menu from the list.

2 Printer

Specifies the Label Printer you want to configure.

If only one Label Printer is connected, it is unnecessary to make a selection because only that Label Printer will appear.

3 Settings Tabs

Contains settings that may be specified or changed.



Note

If  appears in the tab, the settings in that tab cannot be specified or changed. In addition, the settings in the tab will not be applied to the Label Printer even if **[Apply]** is clicked. The settings in the tab will also not be saved or exported when the **[Save in Command File]** or **[Export]** command is used.

4 Current Settings

Retrieves the settings from the currently connected Label Printer and displays them in the dialog box.

Settings will also be retrieved for parameters on tabs with .

5 Disable these settings

When this check box is selected,  appears in the tab, and the settings can no longer be specified or changed.

Settings in a tab where  appears will not be applied to the Label Printer even if **[Apply]** is clicked. In addition, the settings in the tab will not be saved or exported when the **[Save in Command File]** or **[Export]** command is used.

6 Parameters

Displays the current settings.

7 Exit

Exits **[Device Settings]** and returns to the main window of the Printer Setting Tool.

8 Apply

Applies the settings to the Label Printer.

To save the specified settings in a command file, select **[Save in Command File]** from the drop-down list. The saved command file can be used with the mass storage mode to apply the settings to a Label Printer. For more information, see *Mass Storage Mode (QL-820NWB only)* on page 86.

Menu Bar

The following explains about the menu items in the settings dialog box.

- **Apply Settings to the Printer**

Applies the settings to the Label Printer.

Performs the same operation as when [**Apply**] is clicked.

- **Check Setting**

Displays the current settings.

- **Save Settings in Command File**

Saves the specified settings in a command file.

Performs the same operation as when [**Save in Command File**] is selected from the [**Apply**] drop-down list.

- **Import**

Imports the exported file.

- **Export**

Saves the current settings in a file.

- **Print Unit Settings...**

Prints a report containing firmware version and device setting information.

For QL-810W

You can also print this report using the Cutter (✂) Button. For more information, see *Confirming the Label Printer Settings* on page 84.

For QL-820NWB

You can also print this report using the LCD menu. For more information, see *LCD Settings* on page 12.



Note

When you print this report, use 2.4" (62 mm) DK Roll.

- **Factory Reset**

Resets all the Label Printer settings to the factory settings.

- **Reset only Device Settings**

Deletes the user settings stored in the Label Printer.

- **Delete Template and Database**

Deletes the templates and databases stored in the Label Printer.

- **Option Settings**

If the [**Do not display an error message if the current settings cannot be retrieved at startup**] check box is selected, a message will not be displayed next time.

Basic Tab

The following explains about the Basic Tab in the settings dialog box.

- **Auto Power On**

Specifies whether the Label Printer turns on automatically when the AC Power Cord is plugged into an AC power outlet.

Available settings: [Off], [On]

- **Auto Power Off (AC/DC)**

Specifies the period of time that passes before the Label Printer turns off automatically when connected to an AC power outlet.

Available settings: [None], [10/20/30/40/50/60 Minutes]

- **Auto Power Off (Li-ion)**

Specifies the period of time that passes before the Label Printer turns off automatically when powered by the Rechargeable Li-ion Battery.

Available settings: [None], [10/20/30/40/50/60 Minutes]



Note

Auto Power Off is disabled when connecting with wireless network, wired network (QL-820NWB only), or Bluetooth connection (QL-820NWB only).

- **Eco Charging**

Specifies whether to operate in Eco Charging mode. The service life of the battery can be extended by setting it to charge to [80%] capacity.

Available settings: [100%], [80%]



Note

To get the longest life from the battery, select [80 %]. Although the number of pages that can be printed on a single charge will be less when you select [80 %], you can get a longer life from the battery.

Advanced Tab

The following explains about the Advanced Tab in the settings dialog box.

- **Print Density (Black)**

Sets the density of black.

Available settings: [+6/+5/+4/+3/+2/+1/0/-1/-2/-3/-4/-5/-6]

- **Print Density (Red)**

Sets the density of red.

Available settings: [+6/+5/+4/+3/+2/+1/0/-1/-2/-3/-4/-5/-6]

- **Print Data after Printing**

Specifies whether or not print data is erased after printing.

Available settings: [Keep Print Data], [Erase All Print Data]

- **Printer Information Report**

Selects the information you want to include in the Printer Information Report.

Available settings: [All], [Usage Log], [Printer Settings], [Printer Transfer Data]

- **Auto Cut**

Sets the cutting method when printing multiple labels.

Available settings: [OFF], [Auto Cut], [Cut at End] (Only cuts the places that have finished printing when multiple labels are printed.)

- **Serialize Mode**

Available settings: [Cont From Last] (Select to serialize from the last number printed.), [From Starting] (Select to serialize from the default number each time you print.)

Display Tab (QL-820NWB only)

The following explains about the Display Tab in the settings dialog box.

- **Set Clock**

Sets date and time.

Clicking the [**Current Date/Time**] button will sync to the date and time on the computer.

- **Display Brightness**

Sets the brightness of the display. The higher the number, the brighter the display.

Available settings: [+2/+1/0/-1/-2]

- **Backlight**

Switches the backlight On or Off.

Available settings: [On], [Off]

- **Backlight Timeout**

Sets the period of time before the backlight turns off if the Label Printer is not used.

Available settings: [Off] (never turns off), [5/10/20/30/60 seconds]

- **Template Mode**

Specifies whether the Label Printer operates in P-touch Template Mode.

P-touch Template Mode allows you to enter just text and print labels using a previously configured template.

Available settings: [On], [Off]

- **Preset Template**

Specifies whether to display preset templates when using templates other than the factory preset templates.

Available settings: [Show], [Hide]

- **Confirm Print**

Specifies whether a message appears before printing so that the number of copies can be confirmed.

Available settings: [On], [Off]

- **Default Print**

Specifies the default value for the print quantity.

Available settings: [1-999]

Management Tab

The following explains about the Management Tab in the settings dialog box.

❗ Important

To display these tabs, you must have administrator privileges for the computer or the printer.
You can confirm the administrator privileges for the printer in the [**Printer properties**] - [**Security**] tab.

- **Command Mode**

Selects the type of command mode.

Available settings: [**Raster**], [**ESC/P**], [**P-touch Template**]

- **Airplane Mode**

Allows disabling the Bluetooth or Wi-Fi interfaces. This function is useful when you use the Label Printer in a place where signal transmissions are not allowed. The following conditions apply:

QL-810W: Pressing and holding the Wi-Fi (📶) Button and WPS Button will be ineffective.

QL-820NWB: [**WLAN**] and [**Bluetooth**] menu will disappear from the LCD.

Available settings: [**Off**], [**On**]

- **Lock Settings (QL-820NWB only)**

Locks the menu settings so that they cannot be changed.

Mark the settings to be locked using the [**Select**] button.

- **Admin Password (QL-820NWB only)**

Selects On to configure administrator mode. Set a 4-digit password that must be used in order to change the menu settings.

Available settings: [**Off**], [**On**]

- **Unit (QL-820NWB only)**

Specifies the default unit.

Available settings: [**inch**], [**mm**]

- **Language (QL-820NWB only)**

Selects the language of the LCD.

- **Date Format (QL-820NWB only)**

Selects the date format for the clock.

- **Time Format (QL-820NWB only)**

Selects the time format for the clock.

Applying Setting Changes to Multiple Label Printers

- 1 After applying settings to the first Label Printer, disconnect the Label Printer from the computer, and then connect the second Label Printer to the computer.
- 2 Select the newly connected Label Printer from the **[Printer]** drop-down list.
- 3 Click **[Apply]**. The same settings that were applied to the first Label Printer are applied to the second Label Printer.
- 4 Repeat steps 1 – 3 for all Label Printers whose settings you want to change.



Note

To save the current settings in a file, click **[File]** - **[Export]**.

The same settings can be applied to another Label Printer by clicking **[File]** - **[Import]**, and then selecting the exported settings file. For more information, see *Device Settings for Windows* on page 51.

P-touch Template Settings for Windows

The P-touch template mode allows you to insert data into text and barcode objects from a downloaded template using an optional Barcode Scanner, (PA-BR-001) or other devices connected to the Label Printer.

Please note the available options and supplies may vary depending on your country.

To specify or change P-touch Template functions, go to the Printer Setting Tool, and select [**P-touch Template Settings**].



Note

- P-touch template mode is also compatible with other input devices like a scale, testing machine, controller or a programmable logic device.
- For more information on P-touch Template, download the *P-touch Template Manual/Command Reference* (English only)
[Select your region/country.] - [Manuals] - [Choose your product]
- When printing using a P-touch Template, some symbols printed in red or black may look different from when printed using the computer. For more information, see *P-touch Template Manual/Command Reference* (English only)

P-touch Template Settings Dialog Box

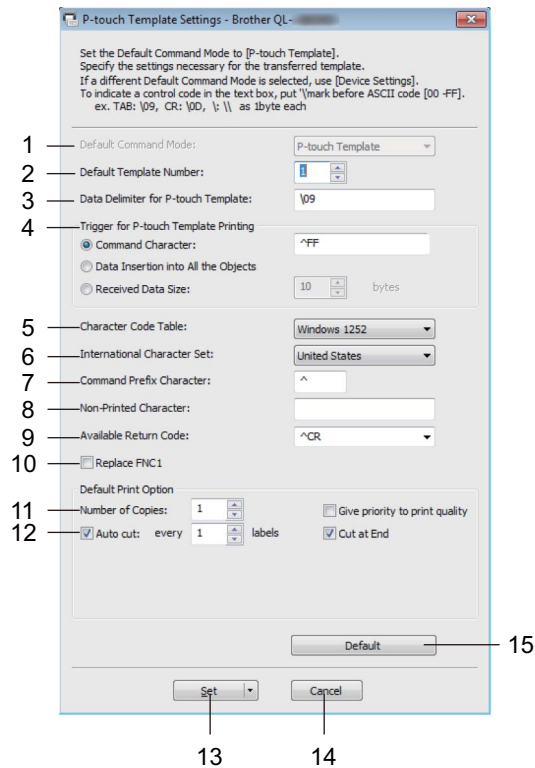

1 Default Command Mode

Specifies the P-touch Template mode as the default mode.
To change the mode, see the *Management Tab* on page 57.

2 Default Template Number

Specifies a default template number that the Label Printer sets when it is turned on. If you do not want to transfer a template to the Label Printer, do not specify a template number.

3 Data Delimiter for P-touch Template

Displays a symbol used to indicate the boundaries between groups of data in a file. Between 1 and 20 characters can be specified.

4 Trigger for P-touch Template Printing

Specifies a trigger to begin printing from a number of options.

[Command Character]: Printing starts when the command character specified here is received.

[Data Insertion into All the Objects]: Printing starts when the delimiter for the last object is received.

[Received Data Size]: Printing starts when the number of characters specified here is received. However, delimiters are not counted in the number of characters.

5 Character Code Table

Selects one of the following character code sets:

Available settings: **[Windows 1252]**, **[Windows 1250 Eastern Europe]**, **[Brother standard]**

6 International Character Set

Lists character sets for specific countries.

Available settings: [United States], [France], [Germany], [Britain], [Denmark], [Sweden], [Italy], [Spain], [Japan], [Norway], [Denmark II], [Spain II], [Latin America], [Korea], [Legal]

The following 12 codes are switched depending on the country selected from the list above:

23h 24h 40h 5Bh 5Ch 5Dh 5Eh 60h 7Bh 7Ch 7Dh 7Eh

For switched characters, download *P-touch Template Manual/Command Reference* (English only)

7 Command Prefix Character

Specifies the prefix character code which identifies commands used in P-touch Template mode.

8 Non-Printed Character

Characters specified here are not printed when data is received. Specify 1 to 20 characters.

9 Available Return Code

The line feed code is used when feeding data to indicate that the following data should be moved to the next line in a text object. One of the following four line feed codes can be selected, or 1 to 20 characters can be specified as the line feed code.

Available settings: [^CR], [\0D\0A], [\0A], [\0D]

10 Replace FNC1

See the *P-touch Template* manual.

11 Number of Copies

Sets the number of copies. A number between 1 and 99 can be specified.

12 Cut option

Specifies whether to cut the labels automatically and how many labels to print before cutting them. A number between 1 and 99 can be specified.

You can also select other cutting options.

13 Set

Applies the settings to the Label Printer.

To save the specified settings in a command file, select [**Save in Command File**] from the drop-down list. The saved command file can be used with the mass storage mode to apply the settings to a Label Printer. For more information, see *Mass Storage Mode (QL-820NWB only)* on page 86.

14 Cancel

Cancels the settings and closes the dialog box. The settings will remain unchanged.

15 Default

Returns to factory settings.

Printer Setting Tool for Mac

Using the Printer Setting Tool, you can specify the Label Printer's communication settings and device settings from a Mac. Not only can you change the device settings for one Label Printer, but you can also apply the same settings to multiple Label Printers.



Note

The Printer Setting Tool is installed automatically when you use the initial installer to install the printer driver. For more information, see *Installing the Software and Printer Drivers to a Computer* on page 22.



Important

The Printer Setting Tool is available only with compatible Brother Label Printers.

Before Using the Printer Setting Tool

- Make sure the AC Adapter is connected to the Label Printer and to an AC power outlet, or a fully-charged battery is installed.
- Make sure the printer driver has been installed correctly and you can print.
- Connect the Label Printer to a computer with a USB cable. Settings cannot be specified using Wi-Fi by using this tool.

Using the Printer Setting Tool for Mac

- 1 Connect the Label Printer you want to configure to the computer.
- 2 Click **[Macintosh HD]** - **[Applications]** - **[Brother]** - **[Printer Setting Tool]** - **[Printer Setting Tool.app]**. The **Printer Setting Tool** window appears.
- 3 Check that the Label Printer you want to configure appears next to **[Printer]**. If a different Label Printer appears, select the Label Printer you want from the pop-up list.



Note

If only one Label Printer is connected, it is unnecessary to make a selection because only that Label Printer will appear.

- 4 Select a settings tab, and then specify or change the settings.
- 5 Click **[Apply Settings to the Printer]** in the settings tab to apply the settings to the Label Printer.
- 6 Click **[Exit]** to finish specifying settings.



Important

Use the Printer Setting Tool to configure the Label Printer only when the Label Printer is waiting for the next print job. The Label Printer may malfunction if you try to configure it while it is handling a print job.

Settings Dialog Box

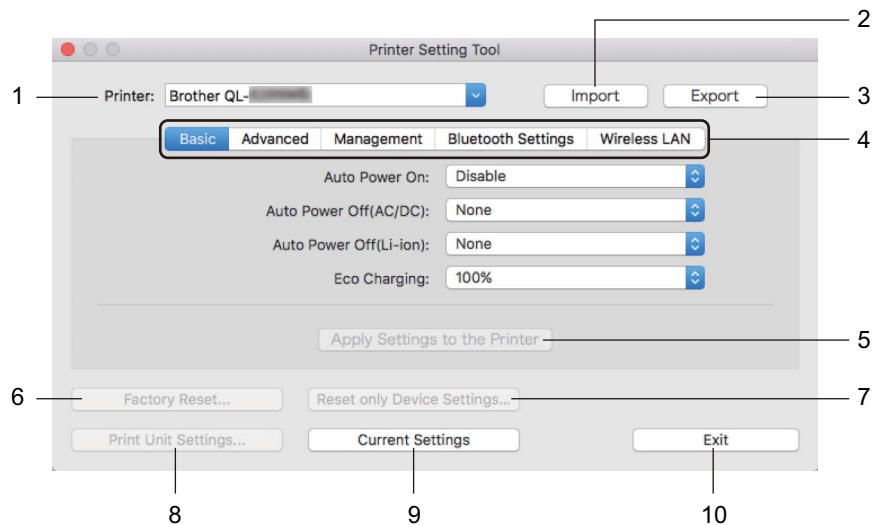

1 Printer

Lists the connected Label Printers.

2 Import

Imports settings from a file.

3 Export

Saves the current settings in a file.

4 Settings Tabs

Contain settings that may be specified or changed.

5 Apply Settings to the Printer

Applies the settings to the Label Printer.

6 Factory Reset

Resets printer settings to factory settings.

7 Reset only Device Settings...

Resets device settings to the factory settings.

8 Print Unit Settings

Prints a report containing firmware version and device setting information.

For QL-810W

You can also print this report using the Cutter (✂) Button. For more information, see *Confirming the Label Printer Settings* on page 84.

For QL-820NWB

You can also print this report using the LCD menu. For more information, see *LCD Settings* on page 12.



Note

When you print this report, use a 2.4" (62 mm) DK Roll.

9 Current Settings

Retrieves the settings from the currently connected Label Printer and displays them in the dialog box.

10 Exit

Exits the Printer Setting Tool.

Basic Tab

The following explains about the Basic Tab in the settings dialog box.

- **Auto Power On**

Specifies whether the Label Printer turns on automatically when the AC Power Cord is plugged into an AC power outlet.

Available settings: [Disable], [Enable]

- **Auto Power Off (AC/DC)**

Specifies the period of time that passes before the Label Printer turns off automatically when connected to an AC power outlet.

Available settings: [None], [10/20/30/40/50/60 Minutes]

- **Auto Power Off (Li-ion)**

Specifies the period of time that passes before the Label Printer turns off automatically when powered by the Rechargeable Li-ion Battery.

Available settings: [None], [10/20/30/40/50/60 Minutes]



Note

Auto Power Off is disabled when connecting with the wireless network, wired network (QL-820NWB only), or Bluetooth connection (QL-820NWB only).

- **Eco Charging**

Specifies to switch to Eco Charging. The service life of the battery can be extended by setting it to charge to [80%] capacity.

Available settings: [100%], [80%]



Note

To get the longest life from the battery, select [80%]. Although the number of pages that can be printed on a single charge will be less when you select [80%], you can get a longer life from the battery.

Advanced Tab

The following explains about the Advanced Tab in the settings dialog box.

- **Print Density (Black)**

Sets the density of black.

Available settings: [+6/+5/+4/+3/+2/+1/0/-1/-2/-3/-4/-5/-6]

- **Print Density (Red)**

Sets the density of red.

Available settings: [+6/+5/+4/+3/+2/+1/0/-1/-2/-3/-4/-5/-6]

- **Printer Information Report**

Selects the information you want to include in the Printer Information Report.

Available settings: [All], [Usage Log], [Printer Settings], [Printer Transfer Data]

- **Print Data after Printing**

Specifies whether or not print data is erased after printing.

Available settings: [Keep Print Data], [Erase All Print Data]

Management Tab

The following explains about the Management Tab in the settings dialog box.

- **Command Mode**

Selects the type of command mode.

Available settings: [Raster], [ESC/P], [P-touch Template]

- **Airplane Mode**

Selects On to set the Label Printer to Airplane Mode. The following conditions apply:

QL-810W: Pressing and holding the Wi-Fi (📶) Button and WPS Button will be ineffective.

QL-820NWB: [WLAN] and [Bluetooth] menus will disappear from the display.

Available settings: [Off], [On]

Bluetooth Settings Tab (QL-820NWB only)

The following explains about the Bluetooth Settings Tab in the settings dialog box.

- **Bluetooth Device Name**
Displays the Bluetooth device name.
- **Bluetooth Address**
Displays the acquired Bluetooth address.
- **Visible to Other Devices**
Allows the Label Printer to be "discovered" by other Bluetooth devices.
Available settings: [**Discoverable**], [**Not Discoverable**]
- **Auto re-pairing**
Sets whether or not to automatically reconnect to previously connected Apple device (iPad, iPhone, or iPod touch).
Available settings: [**Enable**], [**Disable**]
- **Change PIN code**
If [**On**] is selected, you can change the PIN code that are compliant with Bluetooth 2.1 or earlier.
- **Request Secure Simple Pairing (SSP) settings during pairing**
If this check box is selected, pairing can be performed using the Label Printer buttons for devices that are compliant with Bluetooth 2.1 or later.

Wireless LAN Tab

The following explains about the Wireless LAN Tab in the settings dialog box.

- **WirelessDirect**
Turns the Wireless Direct function on or off.
- **SSID/Network Key Generation**
Selects [**AUTO**] or [**STATIC**].
- **SSID (Network Name)/Network Key**
Specifies the SSID (3 to 25 ASCII characters) and the network key you want to use in the Wireless Direct mode.
You can specify a setting only when [**STATIC**] is selected as [**SSID/Network Key Generation**].
- **Display current settings**
Displays the current settings for Wireless Direct. Click [**Current Settings**] to update the displayed settings with the most recent information.

Applying Setting Changes to Multiple Label Printers

- 1 After applying settings to the first Label Printer, disconnect the Label Printer from the computer, and then connect the second Label Printer to the computer.
- 2 Select the newly connected Label Printer from the [**Printer**] drop-down list.
- 3 Click [**Apply Settings to the Printer**].
The same settings that were applied to the first Label Printer are applied to the second Label Printer.
- 4 Repeat steps 1 – 3 for all Label Printers whose settings you want to change.



Note

To save the current settings in a file, click [**Export**].

The same settings can be applied to another Label Printer by clicking [**Import**], then selecting the exported settings file. For more information, see *Settings Dialog Box* on page 63.

Changing Settings When Printing from a Mobile Device

If using a mobile device, change the settings as necessary using the application before printing. The settings that can be changed vary according to the application.



Note

Before connecting a mobile device, you can specify detailed settings by connecting the Label Printer to a computer and using the Printer Setting Tool. For more information, see *Changing the Label Printer Settings* on page 37.

P-touch Template Operations

The P-touch template mode allows you to insert data into text and barcode objects from a downloaded template using an optional Barcode Scanner (PA-BR-001) or other devices connected to the Label Printer.

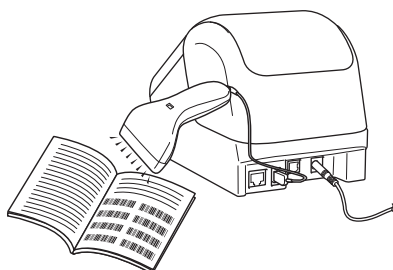

Basic Operations

■ *Standard Template Printing* (See page 73)

Download frequently used templates or images and simply scan a barcode to select which one to print.

■ *Advanced Template Printing* (See page 75)

Download a template and scan a barcode to print a copy, or insert the scanned data into a different template.

■ *Database Lookup Printing* (See page 78)

Download a database linked to a template, and scan a barcode to find a record to insert into the template and print it out.

Advanced Features

■ *Numbering (Serialized Number) Printing* (See page 81)

Automatically increment a text or barcode in any downloaded template while printing.



Note

- P-touch template mode is also compatible with other input devices like a scale, testing machine, controller or a programmable logic device.
- See the *P-touch Template Manual/Command Reference* for more information.
[Select your region/country.] - [Manuals] - [Choose your product]
- When printing using a P-touch Template, some symbols printed in red and black may look different from when printed using the computer. For more information, see the *Raster Command reference*.
- The use of the GHS (Globally Harmonized System of Classification and Labeling of Chemicals) symbols is strictly governed by one or more directives.
- The GHS templates provided are samples. Please ensure that any labels you produce using these symbols conform with the relevant directives.

Preparation

Before connecting the Barcode Scanner to the Label Printer, specify the Barcode Scanner settings using the P-touch Template Settings (inside Printer Setting Tool).

Specifying Settings in the P-touch Template Settings Tool

- 1 Connect the Label Printer and the computer using a USB cable, and then turn on the Label Printer.
- 2 Start the Printer Setting Tool.
 - **For Windows Vista / Windows 7 / Windows Server 2008 / Windows Server 2008 R2:**
From the Start button, click [All Programs] - [Brother] - [Label & Mobile Printer] - [Printer Setting Tool].
 - **For Windows 8 / Windows 8.1 / Windows Server 2012 / Windows Server 2012 R2:**
Click the [Printer Setting Tool] icon on the [Apps] screen.
 - **For Windows 10:**
From the Start button, click [Brother] - [Label & Mobile Printer] - [Printer Setting Tool].
- 3 Click [P-touch Template Settings].
- 4 Select the appropriate settings, and then click [Set].

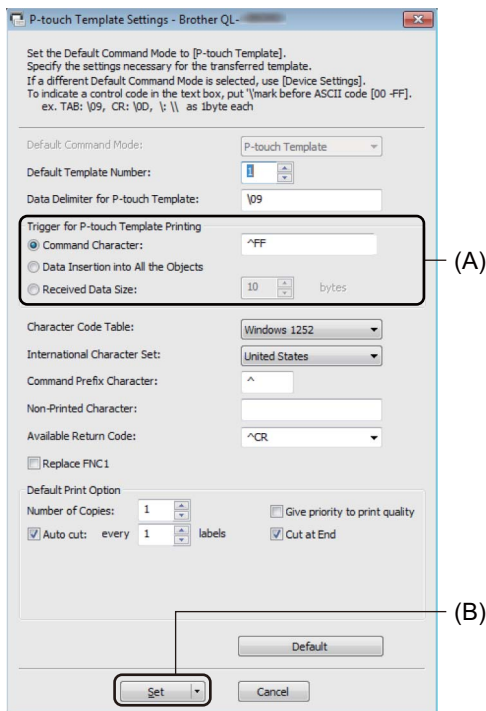



Note

- By default, printing begins when the code "^FF" is scanned from a barcode using a Barcode Scanner. (This can be changed with the settings highlighted by (A) in the previous image.)
If [**Received Data Size**] is selected with the number of bytes setting, the template will automatically print after the specified number of bytes have been scanned.
 - Because the print mode setting will return to raster mode each time you print from the computer, you must change the setting to template mode again.
 - If you turn off the Label Printer and then turn it on again, the Label Printer starts up in template mode.
-

Connecting a Barcode Scanner (QL-820NWB only)

We recommend you use a reliable high-quality Barcode Scanner and you check the Barcode Scanner specifications before selecting a model.

■ Barcode Scanner connection methods:

Use the USB Host interface or Bluetooth interface.

■ Recommended Barcode Scanner selection criteria:

- When using the USB host interface: HID-class models that can be identified as a keyboard (ex. optional: PA-BR-001)
- When using the Bluetooth interface: Bluetooth Ver.2.1+EDR (Class 1) models that support SPP or OPP profiles



Note

- For P-touch Template mode, templates must first be downloaded from a computer to the Label Printer using P-touch Transfer Manager. For more information, see *How to Use P-touch Transfer Manager and P-touch Library (Windows only)* on page 123.
- The barcode scanner should be programmed to use the English keyboard. For beginners, the barcode scanner should be programmed to scan data with no prefix or suffix characters. For advanced users, the prefix and suffix characters can be used as commands to the Label Printer to make a P-touch Template mode solution easier to use.
- Contact the manufacturer for more information on how to use and program a specific Barcode Scanner model.

Standard Template Printing

Download frequently used templates or images and simply scan a barcode to select which one to print.

Example:



Note

- For more information on the barcodes that can be scanned using various settings, see *List of Barcodes for the P-touch Template Function* on page 196.
- Grouped objects will be converted and sent as an image.

- 1 Using P-touch Transfer Manager, transfer (from P-touch Editor) a template (label layout) to the Label Printer. For more information, see *How to Use P-touch Transfer Manager and P-touch Library (Windows only)* on page 123.

Note

A text object in the label layout can be converted to an image. After being converted to an image, the text cannot be changed. This is useful for protecting frequently used templates from being accidentally edited.

In the P-touch Editor Layout window, right-click the text object, and then click [**Properties**]. Click the [**Expanded**] tab, and then select the [**Text Cannot Be Edited**] check box.

Otherwise, click [**Options**] in the [**Tools**] menu, click the [**General**] tab, and then select the [**Display Expanded Tabs of Object Properties**] check box under [**Others**].

When the check box is cleared, the object is converted back to text that can be edited.

- 2 When you transfer data to [**Configurations**] in P-touch Transfer Manager, select the folder containing the data you want to transfer.

Note

- When a template is transferred to [**Configurations**] in P-touch Transfer Manager, the [**Key Assign**] number is automatically assigned.
- You can specify a [**Key Assign**] number between 1 and 255 by using the Label Printer buttons.
- For advanced operation, you can specify a [**Key Assign**] number between 1 and 99 (for QL-810W) and 1 and 255 (for QL-820NWB) for any downloaded templates into the Label Printer but you will need to scan different barcodes in step 6 to select and print it. For more information, download *the P-touch Template Manual/Command Reference* (English only)
[Select your region/country.] - [Manuals] - [Choose your product]
- You can add a custom folder under [**Configurations**], and drag-and-drop a transferred template into that custom folder to manage different sets of templates.

- 3 Select the transferred template and then click [**Transfer**] to download the template to the [**Key Assign**] number in the Label Printer.

- 4 Scan the “P-touch template command (Initialize + begin specifying settings)” barcode. See *List of Barcodes for the P-touch Template Function* on page 196.

- 5 From the list of barcodes under "Basic settings", scan each barcode to send a command or setting to the Label Printer.



Note

- Settings can be made with multiple commands.
- If no settings have been made by scanning the barcode commands, a template will be printed using the P-touch Template settings. The default P-touch Template settings are to print a single copy with **[Auto Cut]** turned **[On]**.

For more information on P-touch Template Settings, download *P-touch Template Manual/Command Reference* (English only)

[Select your region/country.] - [Manuals] - [Choose your product]

- To specify the number of copies you want, scan the "Number of copies" barcode, and then scan the barcodes under "For entering numbers" to specify a three-digit number.

Example:

Specify numbers by scanning the following barcodes: 7-[0][0][7], 15-[0][1][5]

- To change the setting for the number of copies, scan the "Number of copies" barcode again, and then scan the barcodes for the new three-digit number.

- 6 Scan the barcode under "Preset template number" with the same number as the **[Key Assign]** number for the label layout you want.
- 7 The specified label is printed.

Advanced Template Printing

Download a template and scan a barcode to print a copy or insert the scanned data into a different template.



Note

- For more information on the barcodes that can be scanned using various settings, see *List of Barcodes for the P-touch Template Function* on page 196.
- If a barcode has a different protocol than the barcode template already registered with the Label Printer, you may be unable to create or print the barcode.
- Depending on the Barcode Scanner models, some barcode symbols and protocols may not be supported by this Label Printer.

- 1 Using P-touch Transfer Manager, transfer (from P-touch Editor) a template (label layout) to the Label Printer. For more information, see *How to Use P-touch Transfer Manager and P-touch Library (Windows only)* on page 123.



CODE128/9-digit

Important

It is important to design a template to meet the barcode symbology or protocol requirements, especially for the label size and barcode position in the label to fit the maximum number and type of characters being inserted from the barcode scanner. A barcode in the template cannot be created or be scanned if the barcode with the inserted data does not fit entirely within the label printable image area.

- 2 When you transfer data to **[Configurations]** in P-touch Transfer Manager, select the folder containing the data you want to transfer.



Note

- When a template is transferred to **[Configurations]** in P-touch Transfer Manager, the **[Key Assign]** number is automatically assigned.
- You can specify a **[Key Assign]** number between 1 and 10 for any downloaded templates into the Label Printer.
- You can add a custom folder under **[Configurations]**, and drag-and-drop a transferred template into that custom folder to manage different sets of templates.

- 3 Select the transferred template and then click **[Transfer]** to download the template to the **[Key Assign]** number in the Label Printer.

- 4 Scan the “P-touch template command (Initialize + begin specifying settings)” barcode.
For more information, see *List of Barcodes for the P-touch Template Function* on page 196.
- 5 From the list of barcodes under "Basic settings", scan each barcode to send a command or setting to the Label Printer.

 **Note**

- Settings can be made with multiple commands.
- If no settings have been made by scanning the barcode commands, a template will be printed using the P-touch Template settings. The default P-touch Template settings are to print a single copy with **[Auto Cut]** turned **[On]**.

For more information on P-touch Template Setting Tool, download *P-touch Template Manual/Command Reference* (English only)

[Select your region/country.] - [Manuals] - [Choose your product]

- To specify the number of copies you want, scan the “Number of copies” barcode, and then scan the barcodes under “For entering numbers” to specify a three-digit number. The setting is automatically applied when three digits have been specified.

Example:

Specify numbers by scanning the following barcodes: 7-[0][0][7], 15-[0][1][5]

- To change the setting for the number of copies, scan the “Number of copies” barcode again, and then scan the barcodes for the new three-digit number.

- 6 Scan the "Select template" barcode and then scan the barcodes under "For entering numbers" with the same number (three digits) as the **[Key Assign]** number used for the downloaded template to be printed. The downloaded template will be automatically selected after the three digit numbers have been scanned.

Example:

Specify the three digit numbers by scanning the following barcodes: 7-[0][0][7], 15-[0][1][5]

 **Note**

You can use P-touch Editor to create and print a label with a single barcode for step 6.

Example:



- 7 Scan a barcode that contains the data you want inserted into the barcode object in the selected downloaded template from step 6.

Example:



(CODE128/9-digit)

- 8 Scan the "Begin printing" barcode to send the command to start printing.
- 9 The barcode in the printed template will contain the data from the barcode scanned in step 7.

Example:



Database Lookup Printing

You can download a database linked to a template, scan a barcode as a keyword to find a record containing that keyword, and then insert that record into the template and print it out.

 **Note**

- The Label Printer has reserved the leftmost column (field "A") of a downloaded linked database for this operation, therefore the keyword scanned from a barcode must be in this column of the database.
- For the Label Printer to find keywords successfully, the data in the leftmost column (field "A") must match exactly the keywords scanned from a barcode.
- P-touch Editor and the Label Printer can only read one line of data in each field of a linked database so we do not recommend using databases with two or more lines of data in the leftmost column (field "A").
- For more information on the barcodes that can be scanned using various settings, see *List of Barcodes for the P-touch Template Function* on page 196.

- 1 Use P-touch Editor to create a template and connect to a database file. You can link as many columns to a text and barcode objects in the template as needed.

 **Note**

Make sure the keywords are included in the leftmost column (Field "A") but do not link any text or barcode object in the template with field "A" if you do not need that data on the printed label.

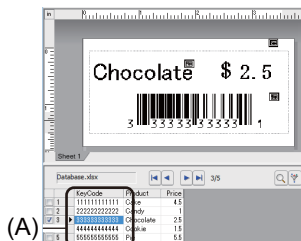

For more information on specifying the settings, refer to the **[P-touch Editor Help]**.

- 2 Using P-touch Transfer Manager, transfer (from P-touch Editor) a template (label layout) to the Label Printer. For more information, see *How to Use P-touch Transfer Manager and P-touch Library (Windows only)* on page 123.
The linked database file will also be transferred.

- 3 When a template is transferred to **[Configurations]** in P-touch Transfer Manager, the **[Key Assign]** number is automatically assigned.

 **Note**

You can add a custom folder under **[Configurations]**, and drag-and-drop a transferred template into that custom folder to manage different sets of templates.

- 4 Select the transferred template and then click **[Transfer]** to download the template to the **[Key Assign]** number in the Label Printer.

- 5 Scan the “P-touch template command” barcode.
For more information, see *List of Barcodes for the P-touch Template Function* on page 196.
- 6 From the list of barcodes under "Basic settings", scan each barcode to send a command or setting to the Label Printer.

 **Note**

- Settings can be made with multiple commands.
- If no settings have been made by scanning the barcode commands, a template will be printed using the P-touch Template settings. The default P-touch Template settings are to print a single copy with **[Auto Cut]** turned **[On]**.

For more information on P-touch Template Setting Tool, download *P-touch Template Manual/Command Reference* (English only)

[Select your region/country.] - [Manuals] - [Choose your product]

- To specify the number of copies you want to print, scan the “Number of copies” barcode, and then scan the barcodes under “For entering numbers” to specify a three-digit number. The setting is automatically applied when three digits have been specified.

Example:

Specify numbers by scanning the following barcodes: 7-[0][0][7], 15-[0][1][5]

- To change the setting for the number of copies, scan the “Number of copies” barcode again, and then scan the barcodes for the new three-digit number.

- 7 Scan the "Select template" barcode and then scan the barcodes under "For entering numbers" with the same number (three digits) as the **[Key Assign]** number used for the downloaded template to be printed. The downloaded template will be automatically selected after the three digit numbers have been scanned.

Example:

Specify the three digit numbers by scanning the following barcodes: 7-[0][0][7], 15-[0][1][5]

Numbering (Serialized Number) Printing

Automatically increment text or barcodes in any downloaded template while printing.



Note

- This advanced operation can be applied to any of the P-touch Template mode basic operations.
- You can automatically increment up to 999 printed copies.
- You can select up to nine text and barcode objects within each downloaded template that will simultaneously be incremented while printing.
- Text and barcode objects linked to a database file cannot be incremented.

Text Numbering (Serializing)

■ Procedure

- 1 Use P-touch Editor to create or open a template and select a text object that you want to automatically increment while printing.
Example:

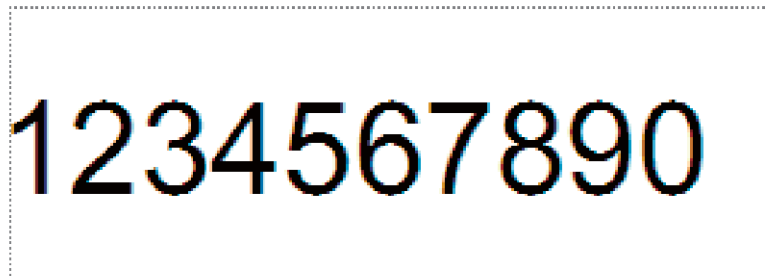

- 2 Highlight or drag the cursor over a group of numbers and letters within the text object that you want to increment (Numbering field).

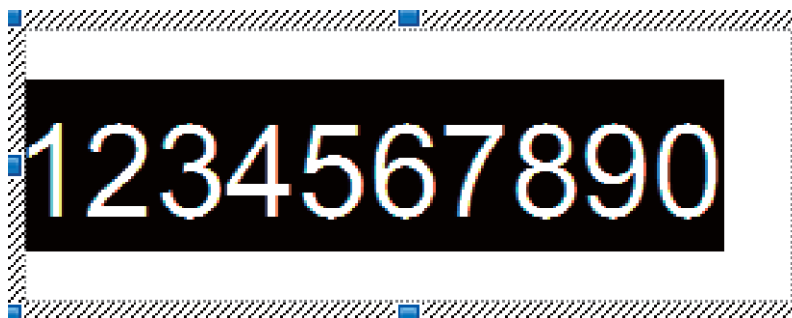

Note

A maximum of 15 numbers and letters can be selected in each Numbering field.

- 3 With the cursor over the highlighted Numbering field, right-click and select **[Numbering]**.

Barcode Numbering (Serializing)

■ Procedure

- 1 Use P-touch Editor to create or open a template and select a barcode object that you want to automatically increment while printing.
- 2 With the cursor over a selected barcode object, right-click and select [**Properties**].
Example:

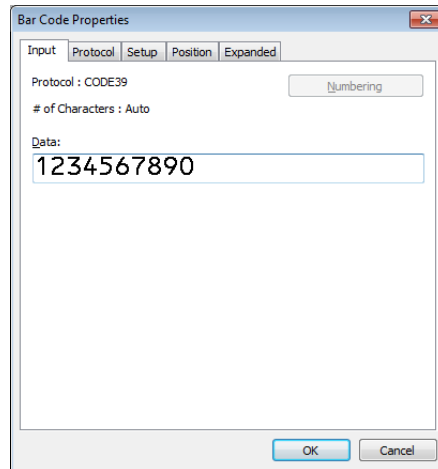

- 3 Click the Input tab and highlight or drag the cursor over a group of numbers and letters within the barcode object that you want to increment (Numbering field).
Example:

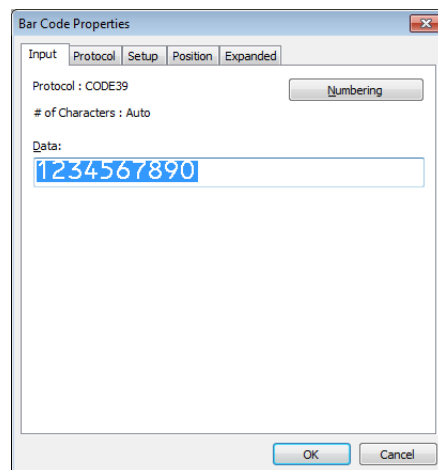

Note

The [**Numbering**] button is enabled after a group of numbers and letters are highlighted.

- 4 Click [**Numbering**], and then click [**OK**].



Note

A maximum of 15 numbers and letters can be selected in each Numbering field.

Printing with Numbering (Serializing) Advanced Operation

- 1 Using P-touch Transfer Manager, transfer (from P-touch Editor) a template (label layout) to the Label Printer. For more information, see *How to Use P-touch Transfer Manager and P-touch Library (Windows only)* on page 123. A linked database file will also be transferred.
- 2 Numbering (Serializing) advanced operation setting the Label Printer. See *List of Barcodes for the P-touch Template Function* on page 196.
 - Scan the "Number of serialized copies" barcode and then scan the barcodes under "For entering numbers" with the number of copies you want to print (three digits).

Example:

For five copies, specify the three digit numbers by scanning barcodes for [0][0][5]



Note

- Follow the P-touch Template mode basic operation procedures to start printing. For further information, see *Standard Template Printing* on page 73 to *Database Lookup Printing* on page 78.
- The Numbering field will increment by one number or letter with each label that is printed, and the count is permanently saved in the Label Printer.
- To reset a text or barcode object back to the original value, scan the "Initialize template data" barcode.

Confirming the Label Printer Settings

You can print the settings report without connecting the Label Printer to a computer or mobile device.

**Note**

The Label Printer report contains the following information: The firmware version, device settings information, serial number, network settings information, and so on. (The printed information is different depending on the model.)

1

Turn on the Label Printer.

2

For QL-810W

Press and hold the Cutter (>⌘) Button for more than one second to print the report.

For QL-820NWB

- 1 Press the Menu, ▲, or ▼ Button to select the [Information] menu, and then press the OK Button.
- 2 Select [Print Configuration] using ▲ or ▼, and then press the OK Button.
- 3 Select [All], [Usage Log], [Printer Setting] or [Transfer Data] using ▲ or ▼ Button, and then press the OK Button to print the report.

**Note**

- When you print this report, use 2.4" (62 mm) DK Roll.
- This operation can also be performed using the Printer Setting Tool. For more information, see *Changing the Label Printer Settings* on page 37.

2-Color Printing Configuration with Other Applications

Follow the process below when carrying out 2-color printing from any other applications than P-touch Editor.

For Windows

- 1 Open the **Devices and Printers** window, select the [QL-810W]/[QL-820NWB] and right-click it. Click [**Printer Properties**].
- 2 Select the [**General**] tab, then click the [**Preferences...**] button.
- 3 Select [**Black/Red**] from the [**Paper Type**] section.

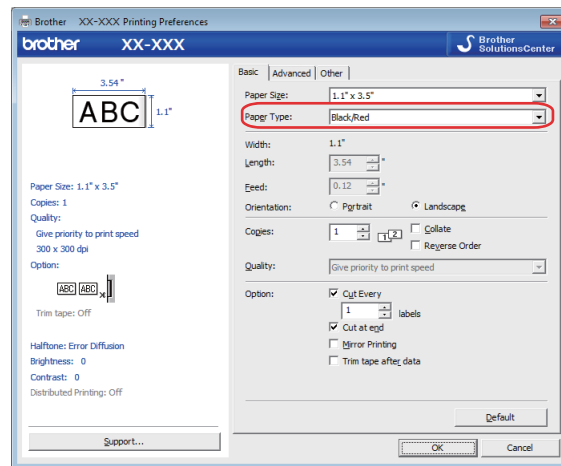

For Mac

- 1 Click [**File**], and then select [**Print**].
The print screen appears.
- 2 Click the [**Show Details**] button.
The other print screen appears.
Click the [**Notes**] pull down to select [**Advanced**].
- 3 Select [**2-Color (Black/Red)**] from the [**Color**] section.

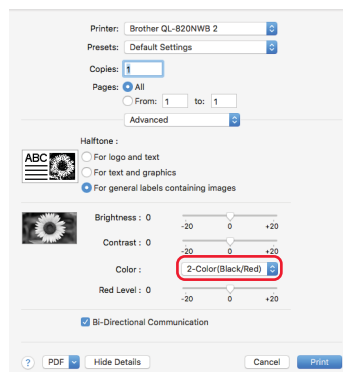

! Important

If printing in monochrome using a 2.4" (62 mm) Black/Red DK Roll, apply the settings as described above.

Mass Storage Mode (QL-820NWB only)

Description

The mass storage feature allows you to send a file to the Label Printer using the USB interface, without installing a printer driver.

This feature is useful for:

- Applying printer settings saved in a command file (.bin file format) or adding templates (.blf file format) into the Label Printer distributed by the administrator without using any software tools.
- Executing commands without installing the printer driver
- Using a device with an operating system (including non-Windows operating systems) that has a USB host feature to print and transmit data

Using the Mass Storage Mode

- 1 Confirm that the Label Printer is turned off.
- 2 Press and hold the OK Button and the Power (⏻) Button at the same time for several seconds. The Label Printer starts up in mass storage mode, the Status LED lights in green and [Mass Storage Mode] appears on the LCD.
- 3 Connect the computer or device to the Label Printer via USB. The Label Printer's mass storage area appears as a folder on the computer or device's screen.



Note

If the mass storage area does not appear automatically, refer to the operating instructions for the computer or device's operating system for information about accessing the mass storage area.

- 4 Drag and drop the file you want to copy to the mass storage area.
- 5 Press the OK Button. The commands in the command file are executed, and the Status LED flashes once in orange. When finished, the Status LED lights in green.
- 6 To turn mass storage mode off, turn off the Label Printer.



Important

- When the Label Printer is turned off, mass storage mode is deactivated and any files in the mass storage area are deleted.
 - This feature supports .bin, and .blf files. Other file formats are not supported.
 - Do not create folders in the mass storage area. If a folder is created, files in the folder cannot be accessed.
 - The capacity of the mass storage area is 2.5 MB. Files larger than 2 MB may not work correctly.
 - If multiple files are copied, the order that the commands will be executed cannot be guaranteed.
 - Wired LAN, Bluetooth (QL-820NWB only) and Wi-Fi are not available while the Label Printer is running in mass storage mode.
 - Do not access other files in the mass storage area when executing a copied file.
-



Note

For more information on how to create a .blf file, see *Creating Transfer Files and Transfer Package Files* on page 133.

JPEG Printing

Image data (JPEG) can be printed without using the printer driver.



Note

- JPEG images can be printed using the mass storage feature.
 - The Object Push Profile (OPP) is used for printing via a Bluetooth connection.
 - The Label Printer will convert a color JPEG image to a 'Black & White' image using a dithering process.
 - When sending a JPEG image that is already 'Black & White' this dithering process may make your printed image fuzzy.
 - To improve the image quality, try to turn off any preprocessing of the JPEG image.
-
- Only JPEG images can be printed. (Limited to files with the .jpg extension.)
 - The maximum file size is 5 MB.
(2 MB when the mass storage feature is used.)
 - The maximum resolution is as follows:
Height × Width = 8000 × 720 dots
If these limits are exceeded, the data received by the printer will be discarded and not printed.
 - Print is at 1 pixel = 1 dot.
 - The Label Printer performs binary processing (simple binary) to print the image.
 - The image is printed with the height-to-width proportion of the received data.

Template Printing from the Label Printer Using the LCD menu (QL-820NWB only)

Transferred or preset templates can be printed only by the Label Printer using the LCD menu without connecting to a computer or mobile device.

- When you print a template that is not linked to a database

1 Make sure the LCD is in the template mode as shown below:

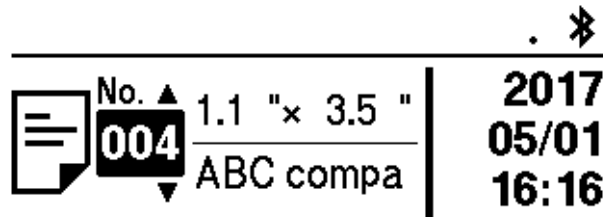

If it is not, set to the template mode.

- 1 Press the Menu Button and ▼ Button to select the [Template Settings] menu, and then press the OK Button.
- 2 Set [Template Mode] to [On].

2 Press ▲ or ▼ Button to select a template and press the OK Button.

- When [Off] is selected on the [Confirm Print] in the [Template Setting] menu
A preset number of labels with the selected template is printed.

- When [On] is selected on the [Confirm Print] in the [Template Setting] menu

- 1 The number of printing setting screen is displayed. Press ▲ or ▼ Button to select the number of labels for printing.

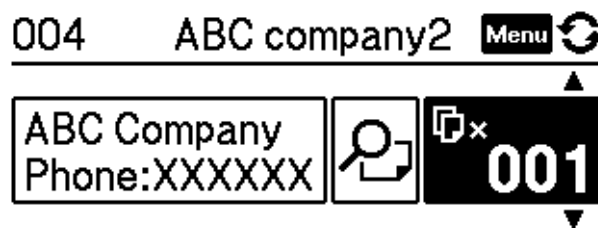

- 2 Press OK Button. The set number of labels with the selected template is printed.

- When you print a template that is linked to a database

1 Make sure the LCD is in the template mode as shown below:

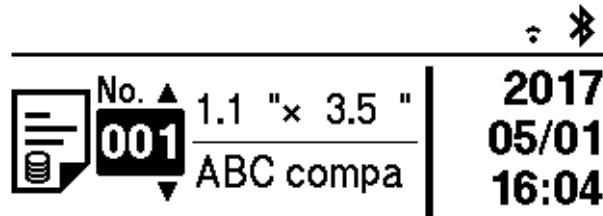

If it is not, set to the template mode.

1 Press the Menu Button and ▼ Button to select the [Template Settings] menu, and then press the OK Button.

2 Set [Template Mode] to [On].

2 Press ▲ or ▼ Button to select a template and press the OK Button.

3 The database selecting screen is displayed. Press ▲ or ▼ Button to select the database and press the OK Button.

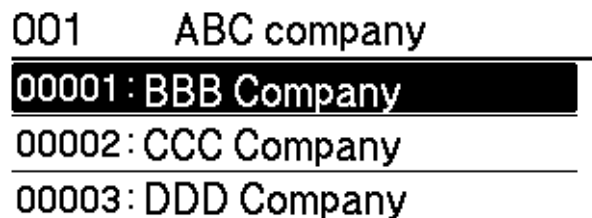

4 The LCD back to the template mode screen.

- When [Off] is selected on the [Confirm Print] in the [Template Setting] menu
A preset number of labels with the selected template is printed.

- When [On] is selected on the [Confirm Print] in the [Template Setting] menu

1 The number of printing setting screen is displayed. Press ▲ or ▼ Button to select the number of labels for printing.

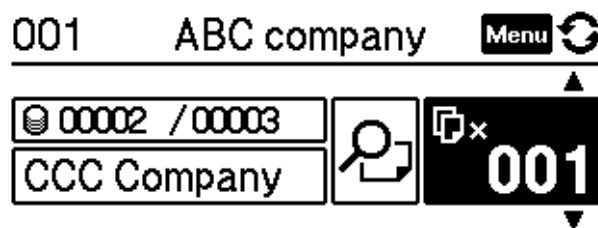

2 Press OK Button. The set number of labels with the selected template is printed.



Note

- When you press the Menu Button once on the number of printing setting screen and then press the OK Button, you can check the Object in the Template. To return to the number of printing setting screen, press the Cancel Button or the OK Button.
 - When you press the Menu Button two times on the number of printing setting screen and then press the OK Button, a print preview is displayed. You can scroll the screen with ▲ or ▼ Button. To return to the number of printing setting screen, press the Cancel Button or the OK Button.
-

Remote Update

Remote Update is a Label Printer feature that facilitates the semi-automatic update of the printer's settings with a simple connection to a network folder where the update files reside. For more information about Remote Update, see *Remote Update* on page 20.

Distributed Printing (Windows only)

When printing a large number of labels, printing can be distributed among multiple Label Printers. Because printing is performed at the same time, the total printing time can be reduced.



Note

- Printing can be distributed to Label Printers connected via a USB or network connection.
- The number of pages is automatically divided among the selected Label Printers. If the specified number of pages cannot be evenly divided among the Label Printers, it will be divided in the order of the Label Printers listed in the dialog box when the print settings are specified in step ④.

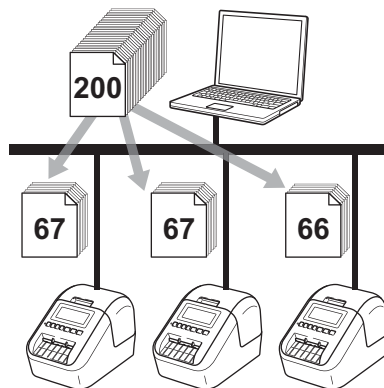

- 1 From the **[File]** menu in P-touch Editor, click **[Print]**.
- 2 Click **[Properties...]**.

- 3 Click the **[Advanced]** tab, select the **[Distributed Printing]** check box, and then click **[Settings]**.

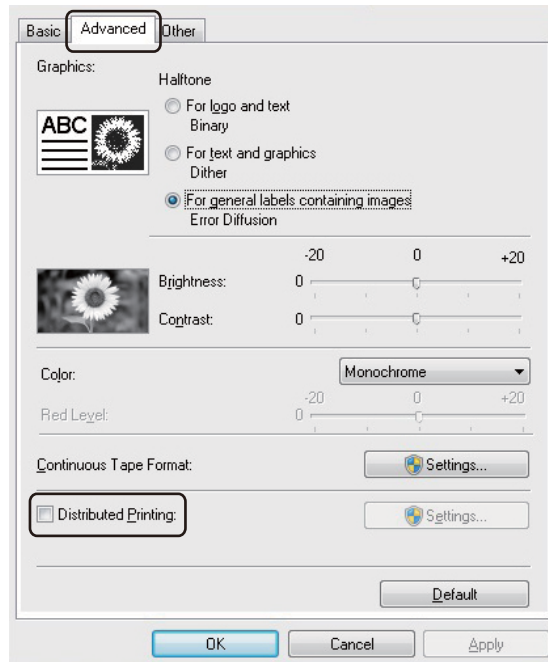

- 4 In the **Distributed Printing Settings** dialog box, select the Label Printers you want to use for distributed printing.

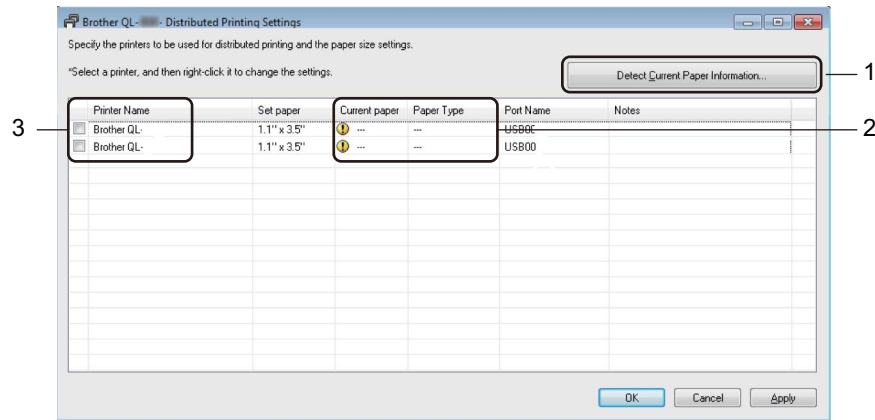

- Click [**Detect Current Paper Information...**] (1).
- The current Label Printer information detected appears below [**Current Paper**] and [**Paper Type**] (2).
- Select the check box next to the [**Printer Name**] you want (3).



Note

- If the selected label width is different from that displayed in the [**Current Paper**] column, the icon appears. Load the Label Printer with the label width specified in [**Set Width**].
- If multiple Label Printers are connected, you can find the Label Printer you want using its port name. The xxxxxxxxxxxx in BRNxxxxxxxxxxxx in the port name indicates the MAC address/Ethernet address of the Label Printer. The MAC address/Ethernet address can be checked by printing the Label Printer set-up information. For more information, see *Confirming the Label Printer Settings* on page 84.

5 Specify the label size.

A. If only one Label Printer has been selected.

In the **Distributed Printing Settings** dialog box from step 4, select the Label Printer whose setting you want to specify, and then either double-click it or right-click it, and then click [**Settings**]. From the [**Set Width**] drop-down list, select the label size.



Note

Information displayed in the **Distributed Printing Settings** dialog box from step 4 can be entered in the [**Notes**] text box.

B. If multiple Label Printers have been selected.

In the **Distributed Printing Settings** dialog box from step 4, select the Label Printers whose settings you want to specify, right-click them, and then click [**Settings**]. From the [**Set Width**] drop-down list, select the label size. The same label size setting is applied to all selected Label Printers.



Note

The settings below [**Printer Settings**] and [**Notes**] are not available.

6 Click [**OK**] to close the label size setting window.

7 Click [**OK**] to close the **Distributed Printing Settings** window. Setup is completed.

8 Click [**OK**] to start distributed printing.



Note

- It may not be possible to detect information for a Label Printer connected using a USB hub or print server. Before printing, enter the settings manually, and check if the Label Printer can be used for printing.
- Depending on whether a router is used and the security features in use, such as a firewall, it may not be possible to use this function.
- We recommend performing a connection test for your operating environment. Contact your information technology manager or administrator for assistance.



Application

How to Use P-touch Editor	97
How to use P-touch Editor Lite (Windows only)	114
How to Use P-touch Transfer Manager and P-touch Library (Windows only)	123
Transferring Templates with P-touch Transfer Express (Windows only)	140
How to Update P-touch Software	148

To use your Label Printer with your computer, install P-touch Editor and the printer driver.

To download the latest driver and software [Select your region/country.] - [Downloads] - [Choose your product]

For Windows

Starting P-touch Editor

1 Start the P-touch Editor.

■ **For Windows Vista / Windows 7 / Windows Server 2008 / Windows Server 2008 R2:**

From the Start button, click [All Programs] - [Brother P-touch] - [P-touch Editor 5.x], or double-click [P-touch Editor 5.x] shortcut icon on the desktop.

■ **For Windows 8/ Windows 8.1 / Windows Server 2012 / Windows Server 2012 R2:**

Click [P-touch Editor 5.x] on the [Apps] screen or double-click [P-touch Editor 5.x] on the desktop.

■ **For Windows 10:**

From the Start button, click [P-touch Editor 5.x] under [Brother P-touch], or double-click [P-touch Editor 5.x] on the desktop.



2 When P-touch Editor starts, select whether you want to create a new layout or open an existing layout.

Note

To change how P-touch Editor functions when it starts, click [Tools] - [Options] in the P-touch Editor menu bar to display the **Options** dialog box. On the left side, select the [General] heading, and then the setting you want in the [Operations] list box under [Startup Settings]. The factory setting is [Display New View].

3 Select one of the displayed options:

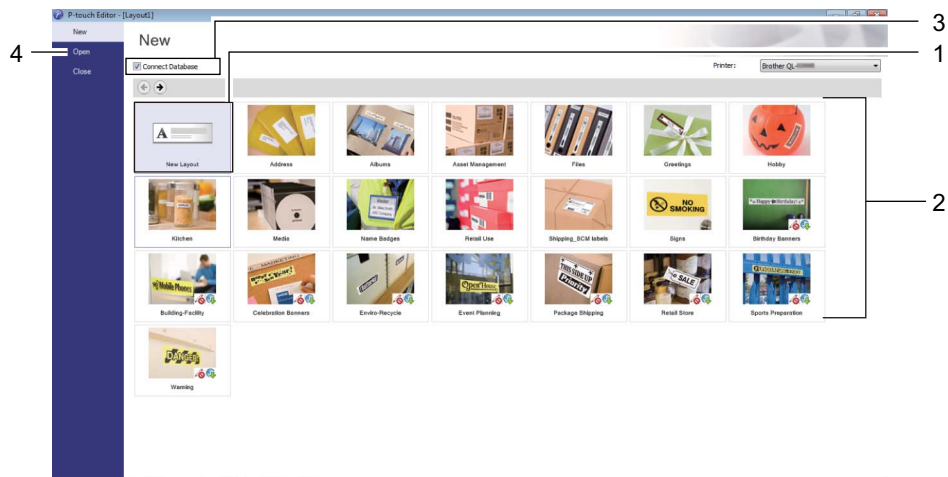

- 1 To create a new layout, double-click **[New Layout]**, or click **[New Layout]** and then click **[→]** .
- 2 To create a new layout using a preset layout, double-click a category button, or select a category button and then click **[→]**.
- 3 To connect a preset layout to a database, select the check box next to **[Connect Database]**.
- 4 To open an existing layout, click **[Open]**.

Printing with P-touch Editor

■ Express mode

This mode allows you to quickly create layouts that include text and images.

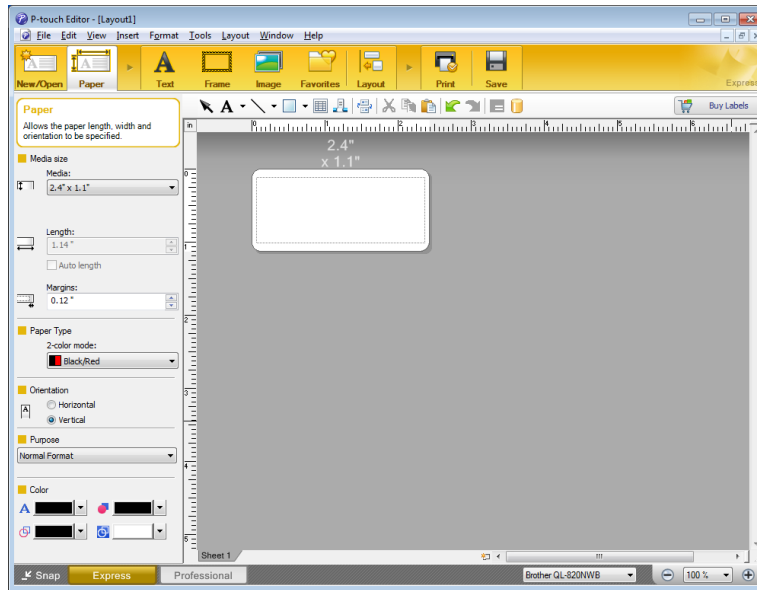

7

To print, click **[File]** - **[Print]** from the menu bar or click the **[Print]** icon. Before printing, configure the print settings in the Print screen.

■ Professional mode

This mode allows you to create layouts using a wide-range of advanced tools and options.

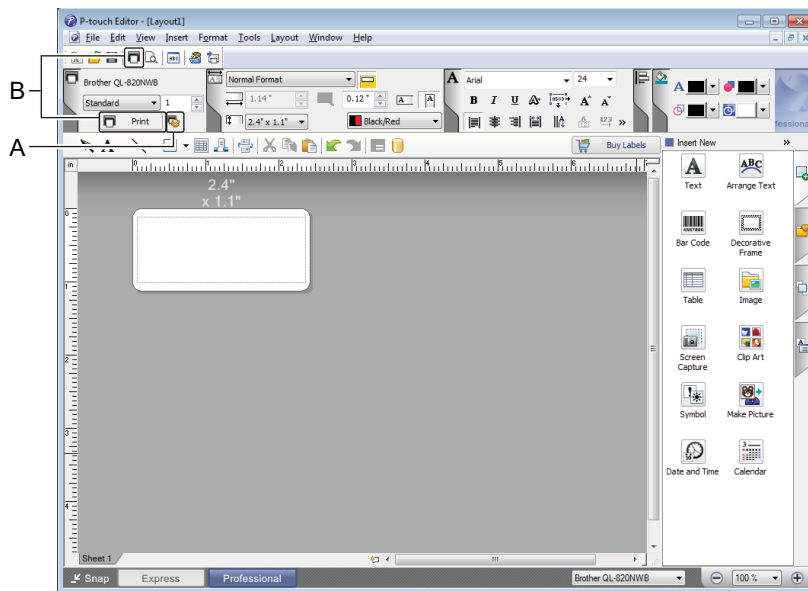

To print, click **[File]** - **[Print]** from the menu bar or click the **[Print]** icon (A). Before printing, configure the print settings in the Print screen.

In addition, you can click the **[Print]** icon (B) to start printing without changing the printing settings.

■ Snap mode

This mode allows you to capture all or a portion of your computer screen display, print it as an image, and save it for future use.

- 1 Click the **[Snap]** mode selection button.
The **Description of Snap mode** dialog box appears.

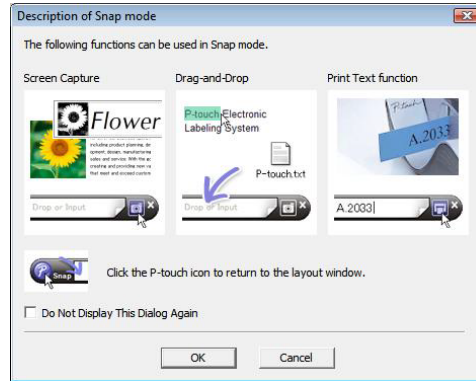

- 2 Click **[OK]**.
The **Snap** mode palette appears.



Transferring Data to the Label Printer

To transfer data to the Label Printer, you must use P-touch Transfer Manager. For more information, see *P-touch Transfer Manager* on page 123.

Printing Using a 2.4" (62 mm) Black/Red DK Roll

Apply the following settings when using the DK Roll (Sample) Tape 2.4" (62 mm) included with the label printer, or the DK-2251 continuous roll (sold separately).

Configuring using P-touch Editor

Express mode

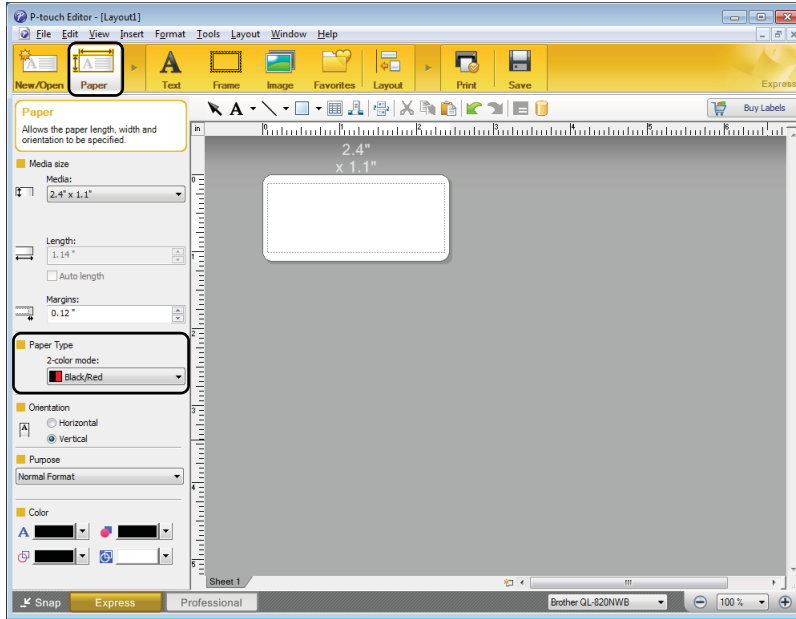

- 1 Select  [Paper] then the 2-color mode appears.
- 2 Select [Black/Red] for [2-color mode:].

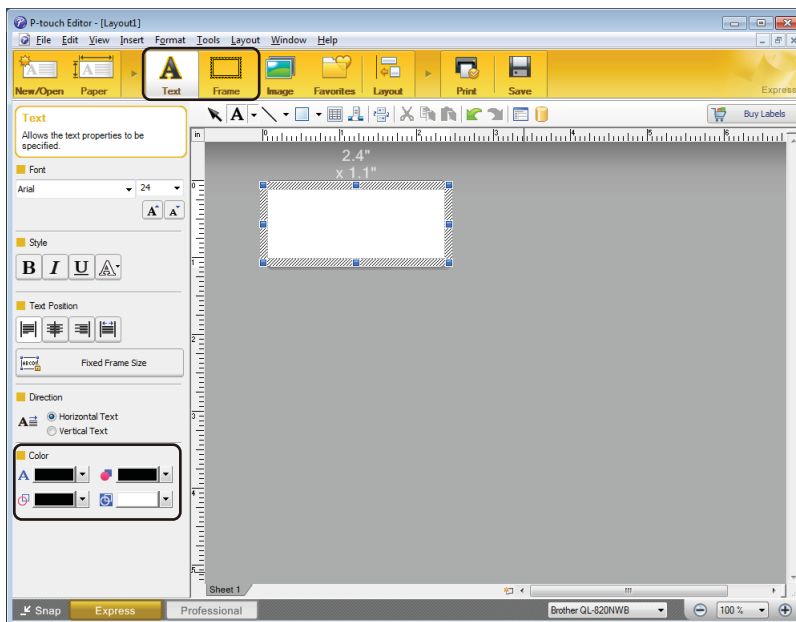

- 3 Select [Text] to edit the color of the text.
- 4 Select [Frame] to edit the color of the frame.

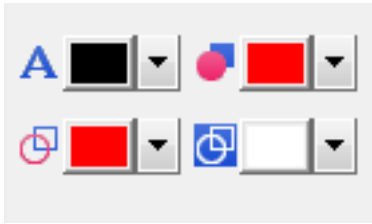

- Use [Sets Text Color for Selected Text] to edit the color of the text.
- Use [Changes the fill color] to edit the color to fill an enclosed area with.
- Use [Changes the color of the line] to edit the color of the line.
- Use [Changes the background color of the object] to edit the background color of the object.

Professional mode

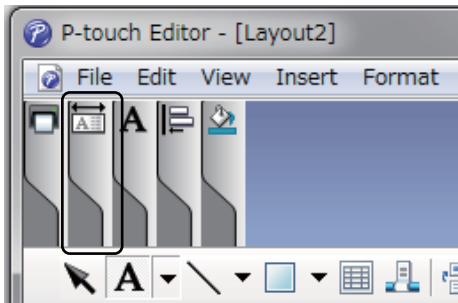

- 1 Click the illustration , then the detailed item will appear.

7

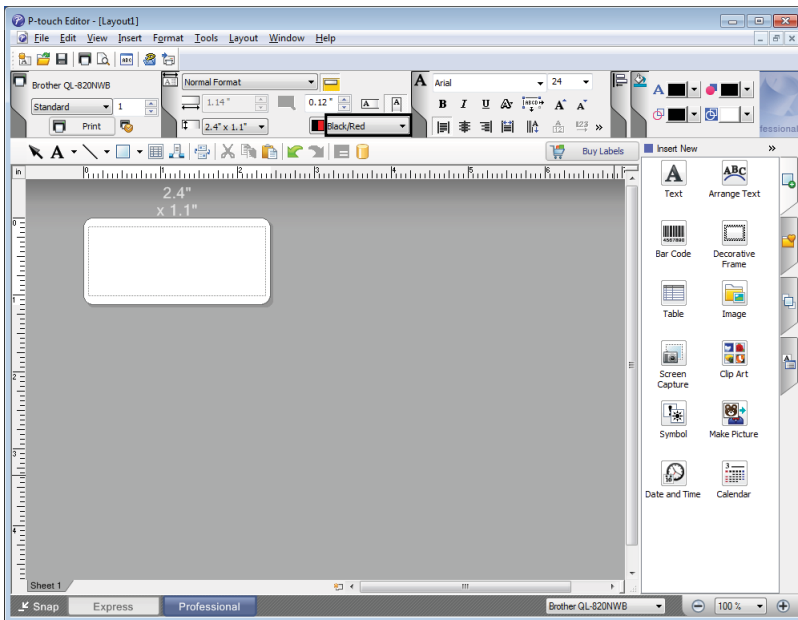

- 2 Select [Black/Red] from the [Paper] tab.

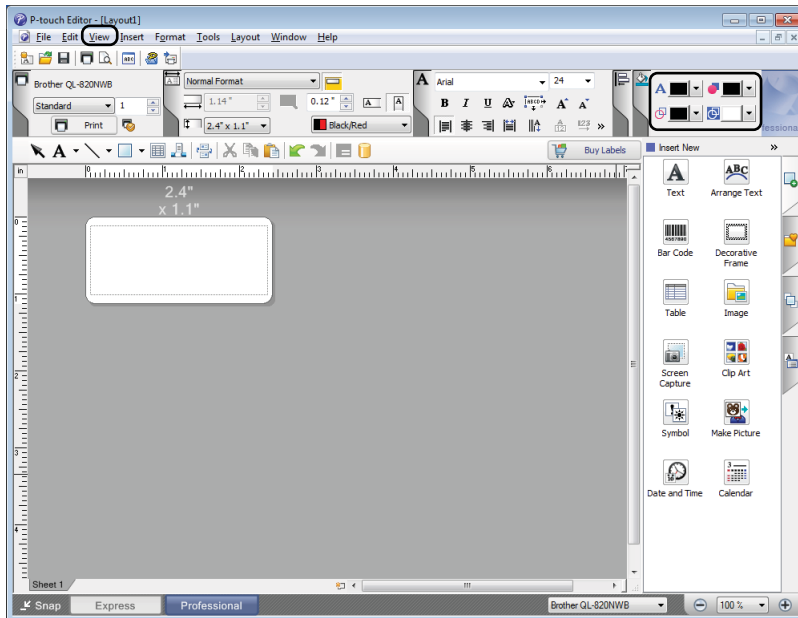

- 3 Click **[View]**, then select **[Property Palette]**, and click **[Color]**. The Color Editing Tool appears.



- Use **A** **[Sets Text Color for Selected Text]** to edit the color of the text.
- Use **[Changes the fill color]** to edit the color to fill an enclosed area with.
- Use **[Changes the color of the line]** to edit the color of the line.
- Use **[Changes the background color of the object]** to edit the background color of the object.



Note

- The Black/Red Print density can be adjusted using the Printer Setting Tool.
- You cannot select High Resolution mode when using 2-color printing.

Adjusting the Color Range, Brightness, and Contrast

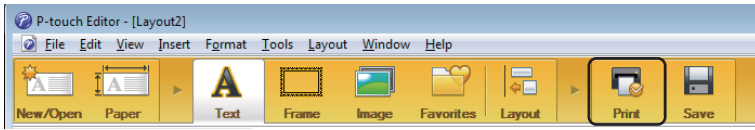

- 1 Open the P-touch Editor [Print] dialog box.

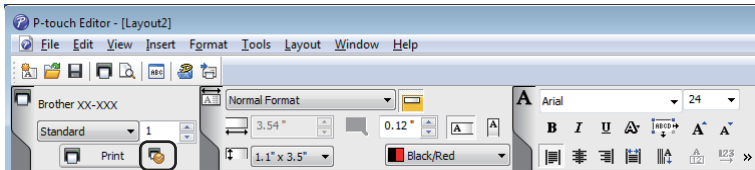

- 2 Click [Properties].

7

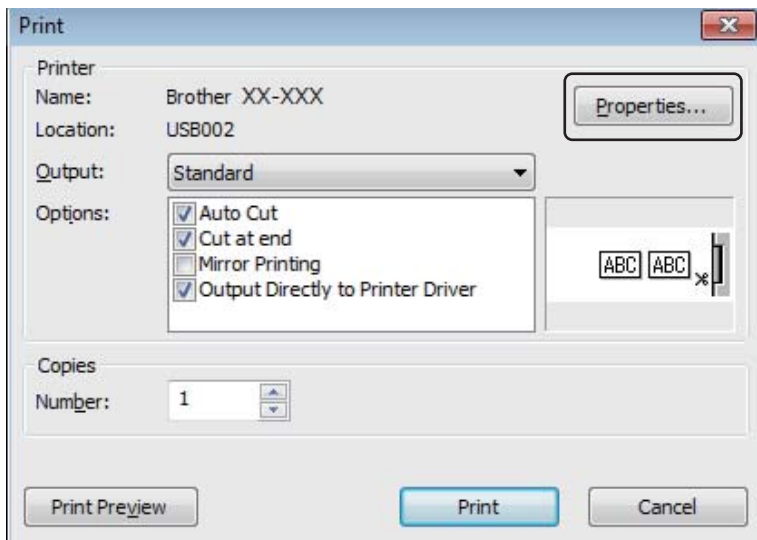

- 3 Select the [Basic] tab.
- 4 Set [Paper Type] to [Black/Red].

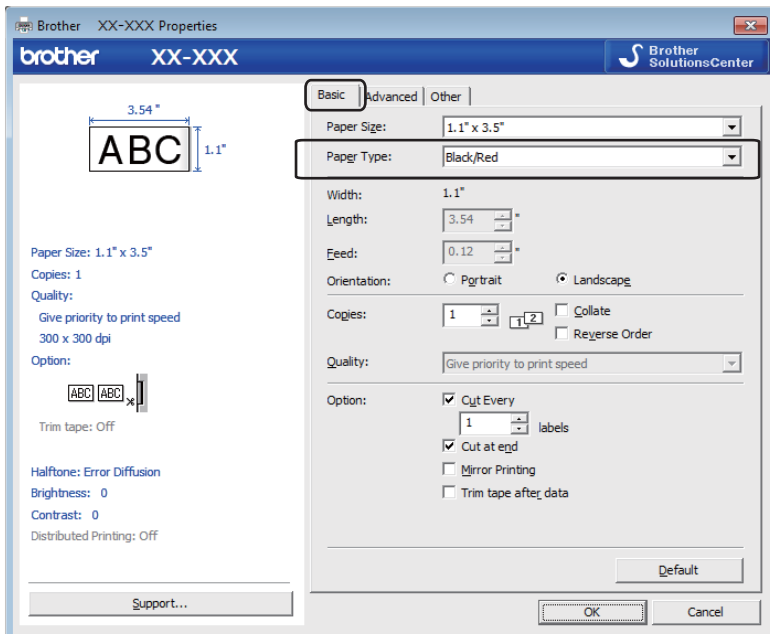

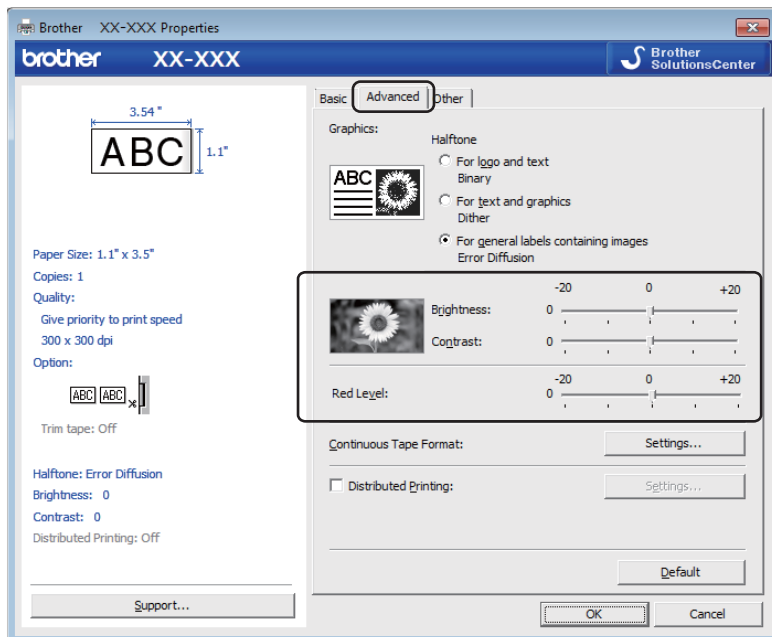

- 5 Select the **[Advanced]** tab.
- 6 Set the **[Brightness]** and **[Contrast]**. (Possible setting range: -20 to +20)
- 7 Set the **[Red Level]**. (Possible setting range: -20 to +20)

For Mac

Starting P-touch Editor

Double-click **[Macintosh HD]** - **[Applications]**, and then double-click the **[P-touch Editor]** application icon.



Note

When using a Mac, you cannot transfer label data created using P-touch Editor to the Label Printer.

Operation modes

■ Standard Mode

This mode allows you to create labels with text and images.

The Layout Window consists of the following sections:

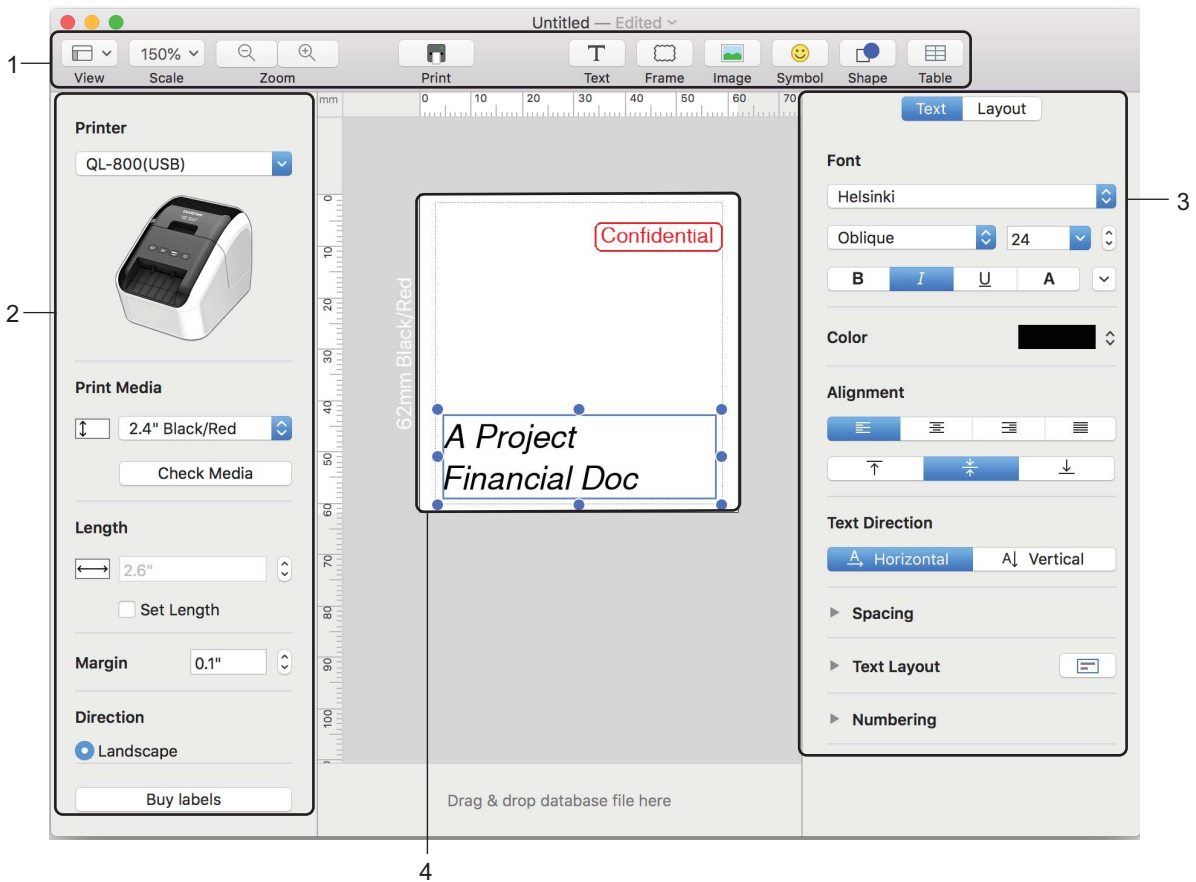

- 1 Toolbar
- 2 Label Inspector
- 3 Object Inspector
- 4 Label Editing Area

Transferring Data to the Label Printer

To transfer data to the Label Printer, you must use a Windows computer. For more information, see *P-touch Transfer Manager* on page 123.

2-Color Printing Configuration

The Label Printer is capable of 2-color printing.

Configuring using P-touch Editor

Standard mode

- 1 Select [2.4" Black/Red].

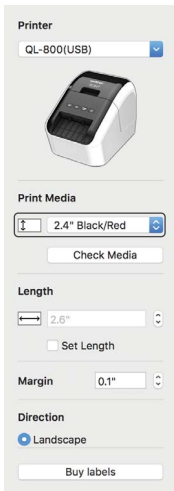

- 2 Change the text, fill, and line colors, as necessary.

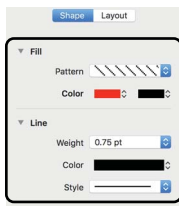
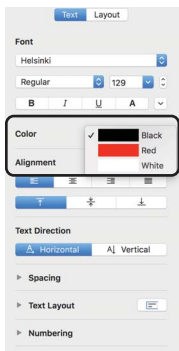

Note

The Black/Red Print density can be adjusted using the Printer Setting Tool.

Adjusting the Color Range

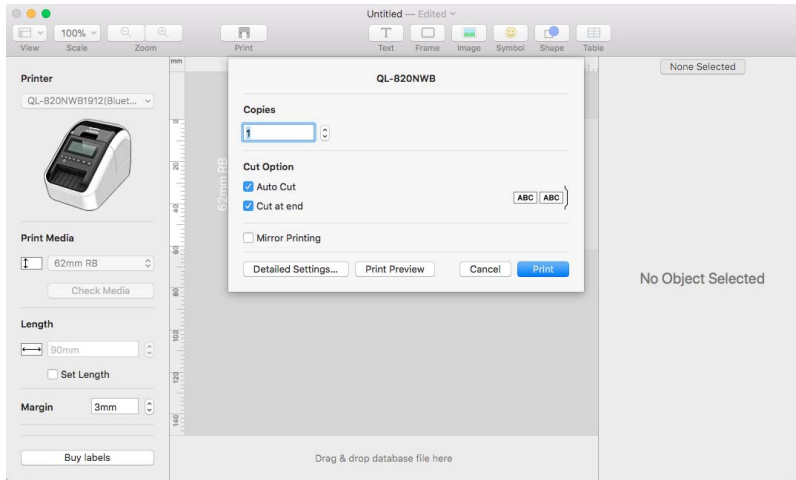

- 1 Open the P-touch Editor [**Print**] dialog box.
- 2 Click the [**Detailed Settings**] button.

7

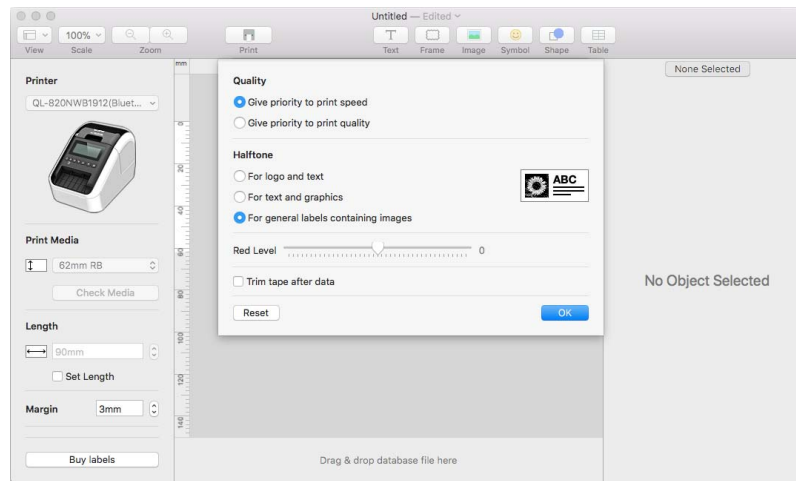

- 3 Set the [**Red Level**]. (Possible setting range: -20 to +20)

How to use the P-touch Address Book (Windows only)

This section describes how to efficiently create labels from contacts using the P-touch Address Book. The screens may differ depending on your operating system.

(P-touch Address Book is not supported in some languages.)

Starting the P-touch Address Book

- 1 Click [Start] - [All Programs] - [Brother P-touch] - [P-touch Address Book 1.2].

Note

You can also start the P-touch Address Book using the following methods (only if you created the shortcut during installation):

- Double-click the Shortcut icon on the desktop.
- Click the Shortcut icon on the Quick Launch bar.

When the P-touch Address Book is launched, the **Startup** dialog box appears, which allows you to create new contacts, import CSV format data, or Outlook contacts.



- 2 In the **Startup** dialog box, specify the P-touch Address Book operation you want to perform and click the [OK] button.

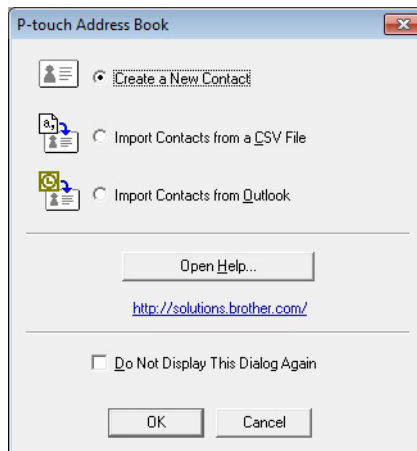

- When [Create a New Contact] is selected, the Layout Window appears.
- When [Import Contacts from a CSV File] or [Import Contacts from Outlook] is selected, you can import contacts in other formats.
- Click the [Open Help...] button to open the P-touch Address Book Help files. The P-touch Address Book Help offers detailed information on available features and explains how to use the P-touch Address Book.

Layout Window

The Layout Window consists of the following eight sections:

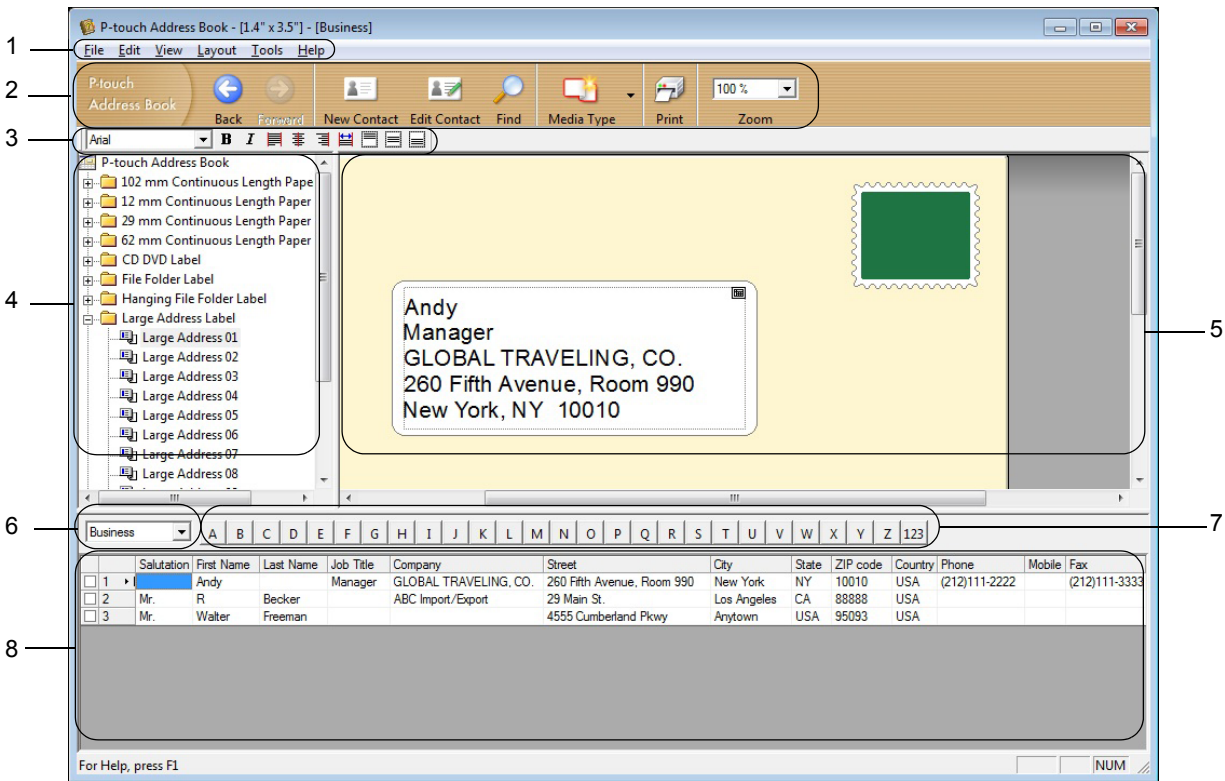

1 Menu Bar

Commands are categorized under each menu (File, Edit, View, Layout and Tools) according to their functions.

2 Standard Toolbar

Provides a group of frequently used commands (such as New Contact, Edit Contact, Find or Print).

3 Text Toolbar

Used to adjust text attributes such as font size and alignment for text formatting.

4 Layout Style Selection View

Displays layout styles stored in the folder.

5 Layout Work Area

Used to display or edit a layout that uses the layout style in the Layout Style Selection view.

6 Contact List Combo Box

Displays the contact list that is currently specified. You can choose from [Personal], [Business], [Other1], [Other2] and [Other3].

7 Index Tab

You can search within the field in Record View. Click [Tools] - [Sort] to open the Sort dialog box, and specify the field you want using [Key1].

8 Record View

Displays the contact data in each field. The data can also be edited (added, deleted or modified).

Creating a new contact



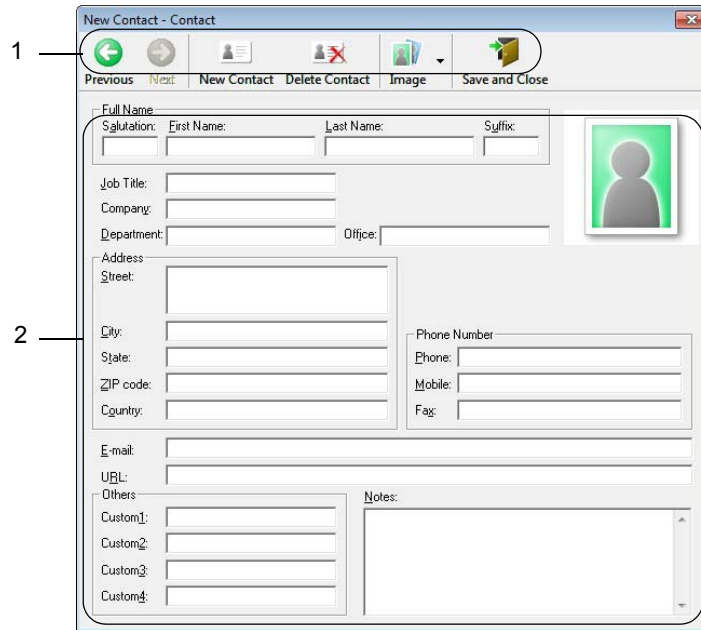

This section explains how to create a new contact.

- 1 Click **[File] - [New Contact]**, or click the New Contact  button.
The **New Contact** dialog box appears.
- 2 Enter the new contact information.

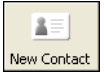

1 New Contact Form Toolbar

The following commands are categorized in the menu:

Icon	Button name	Function
	Previous	Displays the previous contact.
	Next	Displays the next contact.
	New Contact	Displays the form window for a new contact.
	Delete Contact	Deletes the contact that is currently selected.

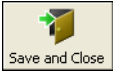
Icon	Button name	Function
	Image	Allows you to insert an image for a contact from a file or a camera currently connected to the computer. The following file types are supported: <ul style="list-style-type: none"> • Bitmap (*.bmp, *.dib) • JPEG file (*.jpg, *.jpeg) • TIFF file (uncompressed) (*.tif) • GIF file (*.gif) • Icon (*.ico) • Windows Meta File (*.wmf, *.emf) (Image adjustment is not allowed.) • PNG file (*.png)
	Save and Close	Saves the contact and closes the New Contact dialog box.

2 Contact Form

Used to enter each item, such as name, address, phone number, company information, and email address for the new contact.

3 When you finish entering the data, click the Save and Close  button to store.



How to use P-touch Editor Lite (Windows only)

How to use P-touch Editor Lite (QL-810W only) (Windows only)

With P-touch Editor Lite, you can quickly create various simple label layouts without installing any drivers or software.

P-touch Editor Lite is only supported when the Label Printer is connected using a USB cable.

After the USB cable is connected, a dialog box appears on the computer screen.

- For Windows Vista, click  (P-touch Editor Lite).
- For Windows 7 / Windows 8 / Windows 8.1 / Windows 10, click "Open folder to view files" and then double-click  (PTLITE10).







P-touch Editor Lite starts.





* The Label Printer must be set to P-touch Editor Lite mode. Press and hold the Editor Lite Button until the Editor Lite LED turns on.

Layout Window

















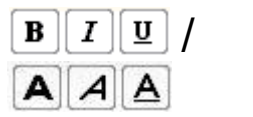







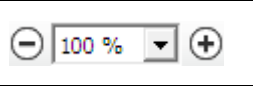

1 Command Toolbar

Icon	Function
	Displays the new label creation screen.
	Opens a saved file with P-touch Editor Lite.
	Saves the data to your computer, but not to the Label Printer.
	Inserts a new text box (useful when creating labels containing both single and multiple lines of text).
	Inserts an image into your label. From file: Inserts an image stored on your computer. Screen capture: Inserts the selected area of the computer screen as a graphic. Symbol: Inserts one of your computer's built-in symbols.
	Inserts a frame.

Icon	Function
	Exits P-touch Editor Lite and starts up P-touch Editor.
	Displays the menu. The menu includes all P-touch Editor Lite functions.
	Minimizes P-touch Editor Lite.
	Exits P-touch Editor Lite.

2 Property Toolbar

Icon	Function
	Click  to change the font.
	Click  to specify the font size. You can adjust the font size up or down one level by clicking  or  .
	Specifies the font style:  /  Bold  /  Italic  /  Underline
	Specifies the alignment of text in a text box.
	Sets the width of the label. Click  to automatically detect the width of the inserted label.
	Sets the length of the label. Click  to automatically adjust the length of the label to accommodate the entered text.
	Sets/cancels the label direction to vertical.
	Click  to set the zoom factor for the Label View. You can also change the zoom factor by clicking  or  .
	Click  to print normally or  to print with options. Auto Cut: Each label is automatically cut after printing. Cut at end: Cuts labels after the last label is printed. Copies: Prints multiple copies of a label.

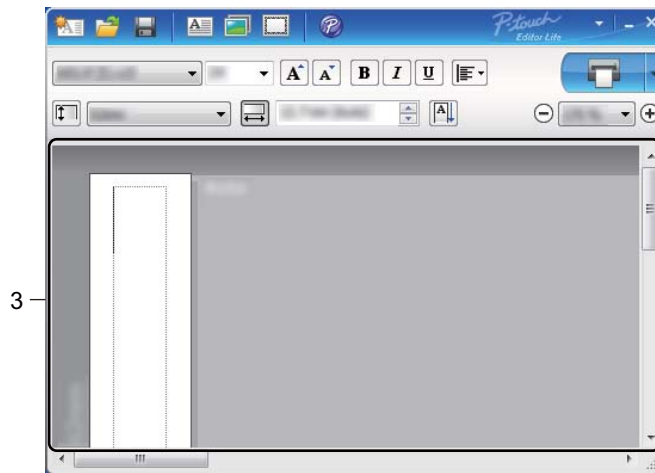

3 Label View

Display	Function
	<p>This label view is displayed when the software is started. The width of label currently set is displayed on the left of the label image. When "Auto" is shown on the right, the length of label is automatically adjusted to the length of text.</p>
	<p>To manually change the length and width of the label, move the pointer to the label area's border, and then drag it when the blue line appears.</p>
	<p>To adjust the size of the P-touch Editor Lite window, move the pointer over an edge of the window and drag it when the pointer changes to an arrow.</p>
	<p>Guidelines are sometimes displayed when moving objects. They are shown when the object is aligned at the left, right, top, or bottom edge of the Printable area, or in the center. In the illustration on the left, the guidelines indicate that the object is centered at the top edge of the label.</p>
	<p>Inserted text boxes, images, and frames are treated as objects. Objects are surrounded by handles (indicated by eight blue points).</p>
	<p>Indicates that an object is selected.</p>
	<p>The pointer changes to an arrow when moved over a handle. Drag the handles to change the object's size.</p>
	<p>To move objects, drag them when the pointer changes to a crosshair. For text objects, the pointer only changes to a crosshair over the border of the object.</p>

Right-click in the layout view area to select and execute the following menu items.

Other Functions (right-click to view)

Menu	Do this
Undo Redo	Click Undo to undo the last operation. Click Redo to redo the last operation.
Cut Copy Paste	Select the text area (or object) that you want to cut or copy and select Cut or Copy . Click in the destination area and select Paste .
Margins	The function is not available for Label Printer.
Insert	Click Insert . Select Text box to insert text into the label. Select From File to insert an image stored on your computer. Select Screen Capture to insert the selected area of the computer screen. Select Symbol to insert one of your computer's built-in symbols. Select Frame to insert one of P-touch Editor Lite's built-in frames.
Direction	Select the text object and click either Horizontal Text or Vertical Text to change the direction of the text.
Numbering	Select the number or letter within your text and click Numbering to insert an incremented number or letter on each label. Click  to the right of the Print button and click Print Options . Select the Numbering box and enter the number of labels for printing in the Count field. Click the Print button.
Change Image	Select the image and click Change Image to replace the current image with a different image.
Rotate	Rotate objects to 0° , 90° , 180° or 270° .
Order	Select one of the objects and click Order , then select Bring to Front , Send to Back , Bring Forward , or Send Backward to set the order of each object in the layer.
P-touch Editor...	Click P-touch Editor to temporarily use P-touch Editor. For continuous use of P-touch Editor, press and hold the Editor Lite Button until the Editor Lite LED turns off.
Options	Click Options . Select either millimeters (mm) or inches (in) to set the measurement unit setting. Select the P-touch Editor Lite language. Restart the application to apply the new selected " Language ". Select either Display New Value after Printing or Reset to Original Value after Printing to set the numbering option.
Brother Solutions Center	Click Brother Solutions Center to go to the website for assistance and information.
About...	Click About to learn about the P-touch Editor Lite version.
Exit	Click Exit to exit P-touch Editor Lite.

How to use P-touch Editor Lite LAN (Windows only)

With P-touch Editor Lite LAN you can quickly create various label layouts.

P-touch Editor Lite LAN is supported only when the machine is connected to a Network.

By downloading the installer from install.brother and installing it, the P-touch Editor Lite LAN program package is created on the desktop. Open the program package and copy it to the shared folder on the server. P-touch Editor Lite LAN on the server can be accessed by other network users to create labels, and print from QL-810W/820NWB connected to the network.

How to share P-touch Editor Lite LAN

- Copy the folder containing P-touch Editor Lite LAN from the shared folder on the network to your computer.
- Start up P-touch Editor Lite LAN from the shared folder on the network.

- 1 Double-click the  in the PteLiteLAN folder.
P-touch Editor Lite LAN starts.

Layout window











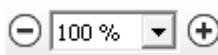

1 Command Toolbar

Icon	Function
	Displays the new label creation screen.
	Opens a saved file with P-touch Editor Lite LAN.
	Saves the data to your computer, but not to the Label Printer.
	Inserts a new text box (convenient when creating labels containing both single and multiple lines of text).
	Inserts an image into your label. From file: Inserts an image stored on your computer. Screen capture: Inserts the selected area of the computer screen as a graphic. Symbol: Inserts one of your computer's built-in symbols.
	Inserts a frame.
	Displays the menu. The menu includes all P-touch Editor Lite LAN functionality.
	Minimizes P-touch Editor Lite LAN.
	Exits P-touch Editor Lite LAN.

3 Property Toolbar

Icon	Function
	Click to change the font.
	Click to specify the font size. You can adjust the font size up or down one level by clicking or .
	Specifies the font style: / Bold / Italic / Underline
	Specifies the alignment of text in a text box.
	Sets the width of the label. Click to automatically detect the width of the inserted label.

Icon	Function
 	<p>Sets the length of the label. Click  to automatically adjust the length of the label to accommodate the entered text.</p>
	<p>Changes the label direction to vertical.</p>
	<p>Click  to set the zoom factor for the Label View. You can also change the zoom factor by clicking  or .</p>
	<p>Click  to print normally or  to print with options. Print Options...: Auto Cut, Cut at end, Copies Auto Cut: Each label is automatically cut after printing. Cut at end: Cuts labels after the last label is printed. Copies: Prints multiple copies of a label. Printer Setup...: Displays a list of the connected Label Printers.</p>

 **Note**

- If multiple Label Printers are connected to the network, select the Label Printer to print with. A list of the Label Printers connected to the network can be displayed by clicking  and then clicking [Printer Setup...]. You can find the Label Printer you want in the list from its IP address.
- The IP address of Label Printers can be checked by printing the Label Printer set-up information. Press and hold the Cutter (✂) Button when the power is on to print the Label Printer set-up information.
- We recommend that you set the Label Printer location using BRAdmin because it enables you to view the Label Printer in the list.

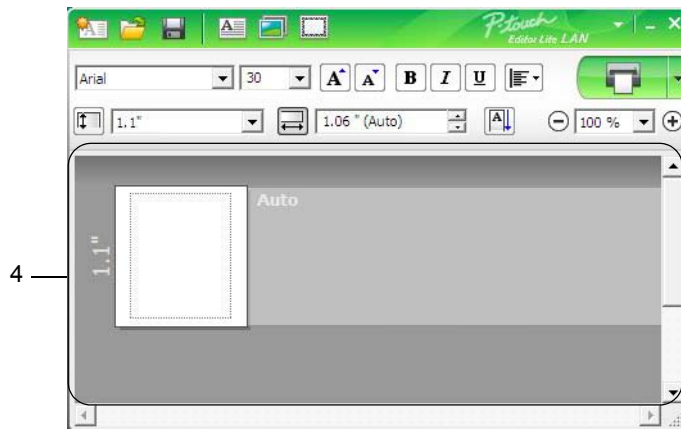

4 Label View

Display	Function
	This label view is displayed when the software is started. The width of label currently set is displayed on the left of label image. When "Auto" is shown on the right, the length of label is automatically adjusted to the length of text.
	To manually change the length and width of the label, move the pointer to the label area's border, and then drag it when the blue line appears.
	To adjust the size of the P-touch Editor Lite LAN window, move the pointer over an edge of the window and drag it when the pointer changes to an arrow.
	Guidelines are sometimes displayed when moving objects. They are shown when the object is aligned at the left, right, top, or bottom edge of Printable area, or in the center. In the illustration to the left, the guidelines indicate that the object is centered at the top edge of the label.
	Inserted text boxes, images, and frames are treated as objects. Objects are surrounded by handles (indicated by eight blue points).
	Indicates that an object is selected.
	The pointer changes to an arrow when moved over a handle. Drag the handles to change the object's size.
	To move objects, drag them when the pointer changes to a crosshair. For text objects, the pointer only changes to a crosshair over the border of the object.

Right-click in the layout view area to select and execute the following menu items.

Other Functions (right-click to view)

Menu	Do this
Undo Redo	Click Undo to undo the last operation. Click Redo to redo the last operation.
Cut Copy Paste	Select the text area (or object) that you want to cut or copy and select Cut or Copy . Click in the destination area and select Paste .
Margins	The function is not available for Label Printer.
Insert	Click Insert . Select Text box to insert text into the label. Select From File to insert an image stored on your computer. Select Screen Capture to insert the selected area of the computer screen. Select Symbol to insert one of your computer's built-in symbols. Select Frame to insert one of P-touch Editor Lite LAN built-in frames.
Direction	Select the text object and click either Horizontal Text or Vertical Text to change the direction of the text.
Numbering	Select the number or letter within your text and click Numbering to insert an incremented number or letter on each label. Click  to the right of the Print button and click Print Options . Check the Numbering box and enter the number of labels for printing in the Count field. Click the Print button.
Change Image	Select the image and click Change Image to replace the current image with a different image.
Rotate	Rotate objects to 0° , 90° , 180° or 270° .
Order	Select one of the objects and click Order , then select Bring to Front , Send to Back , Bring Forward , or Send Backward to set the order of each object in the layer.
Options	Click Options . Select either mm (millimeters) or inches (in) to set the measurement unit setting. Select P-touch Editor Lite LAN language. Restart the application to apply the new selected " Language ". Select either Display New Value after Printing or Reset to Original Value after Printing to set the numbering option.
Brother Solutions Center	Click Brother Solutions Center to go to the website for assistance and information.
About	Click About to learn about the P-touch Editor Lite LAN version.
Exit	Click Exit to exit P-touch Editor Lite LAN.

How to Use P-touch Transfer Manager and P-touch Library (Windows only)

P-touch Transfer Manager

This program allows you to transfer templates and other data to the Label Printer and save backups of your data on the computer.

First P-touch Transfer Manager transfers data to the Label Printer, and then P-touch Template sends text data that will be inserted into the template and printed. For more information on P-touch Template, download the *P-touch Template Manual/Command Reference* (English only) [Select your region/country.] - [Manuals] - [Choose your product]

The transfer function is needed to use P-touch Template.

The template can also be transferred via the network.

Transferring the Template to P-touch Transfer Manager

To use P-touch Transfer Manager, you must first transfer templates created in P-touch Editor to P-touch Transfer Manager.

- 1 In P-touch Editor, open the template you want.
- 2 Click [File] - [Transfer Template] - [Transfer].

When P-touch Transfer Manager starts, the Main window appears.



Note

The following method can also be used to start the P-touch Transfer Manager:

- **For Windows Vista / Windows 7 / Windows Server 2008 / Windows Server 2008 R2:**
From the Start button, click [All Programs] - [Brother P-touch] - [P-touch Tools] - [P-touch Transfer Manager 2.2].
- **For Windows 8 / Windows 8.1 / Windows Server 2012 / Windows Server 2012 R2:**
Click [P-touch Transfer Manager 2.2] on the [Apps] screen.
- **For Windows 10:**
From the Start button, click [P-touch Transfer Manager 2.2] under [Brother P-touch].

Main window

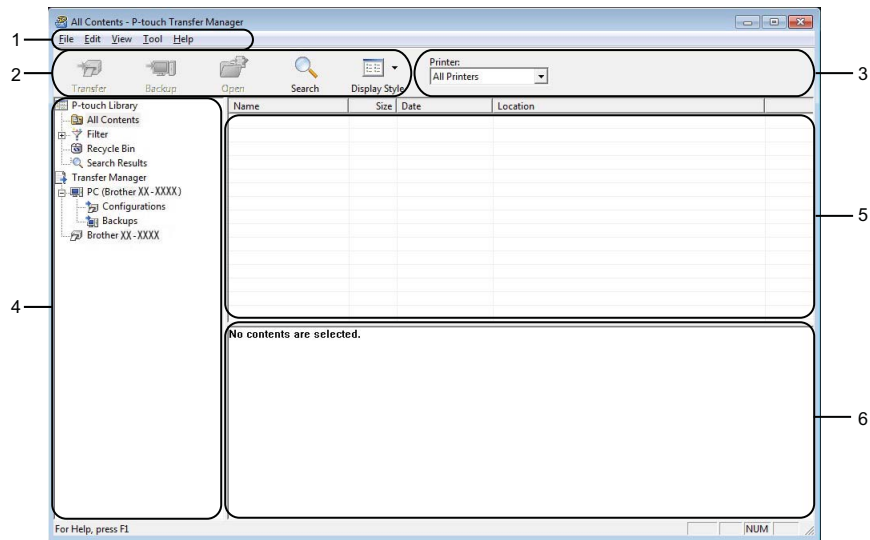

1 Menu Bar

Provides access to various commands, which are grouped under each menu title ([File], [Edit], [View], [Tool], and [Help]) according to their functions.

2 Toolbar

Provides access to frequently used commands.

3 Printer Selector

Allows you to select which Label Printer the data will be transferred to. When you select a Label Printer, only the data that can be sent to the selected Label Printer appears in the data list.

4 Folder List

Displays a list of folders and Label Printers. When you select a folder, the templates in the selected folder appear in the template list.

If you select a Label Printer, the current templates and other data stored in the Label Printer appear.





5 Template List

Displays a list of templates in the selected folder.

6 Preview

Displays a preview of the templates in the templates list.

Explanations of the Toolbar Icons

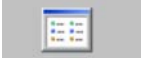
Icon	Button name	Function
	Transfer	Transfers templates and other data from the computer to the Label Printer.
	Save Transfer File (When not connected to a Label Printer)	Changes the file type of the data to be transferred to other applications. Select "BLF" for the filename extension when printing the label using Mass Storage Mode (USB), or when transferring the data using BRAdmin Professional (LAN or Wi-Fi) or Mobile Transfer Express (Wi-Fi). Select "PDZ" when transferring the data using Transfer Express (USB). The available interfaces differ depending on your model.
	Backup	Retrieves the templates and other data saved in the Label Printer and saves it on the computer.
	Open	Opens the selected template.
	Search	Allows you to search for templates or other data registered to P-touch Library.
	Display Style	Changes the file display style.

Transferring Templates or Other Data from the Computer to the Label Printer

Use the following procedure to transfer templates, databases and images from the computer to the Label Printer.

- 1 Connect the computer and the Label Printer via USB and turn on the Label Printer.
The Label Printer model name appears next to a printer icon in the folder view.
If you select the Label Printer in the folder view, the current templates and other data stored in the Label Printer appear.

Note

- If a Label Printer is disconnected or offline, it does not appear in the folder view.
- Before transferring data, check that the computer and the Label Printer are correctly connected using a USB cable or a wireless connection, and that the Label Printer is on.

- 2 Select the Label Printer that you want to transfer the template or other data to.

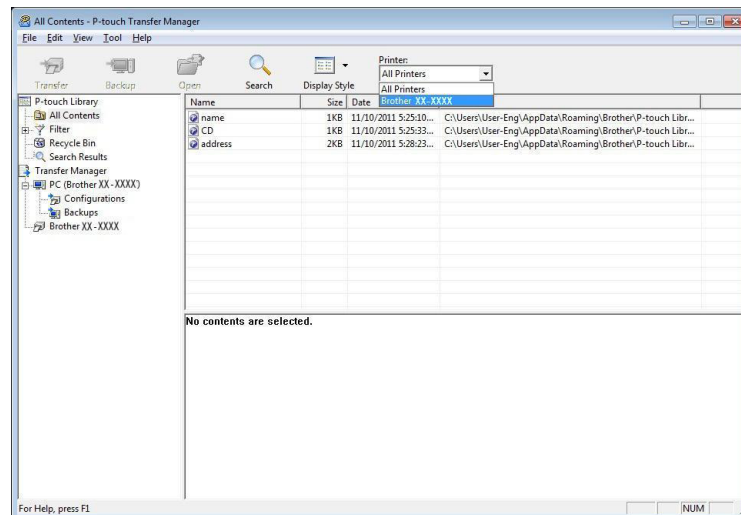

Note

Before transferring data, check that the computer and the Label Printer are correctly connected with a USB cable or a wireless connection, and that the Label Printer is on.

- Right-click the **[Configurations]** folder, select **[New]**, and then create a new folder.

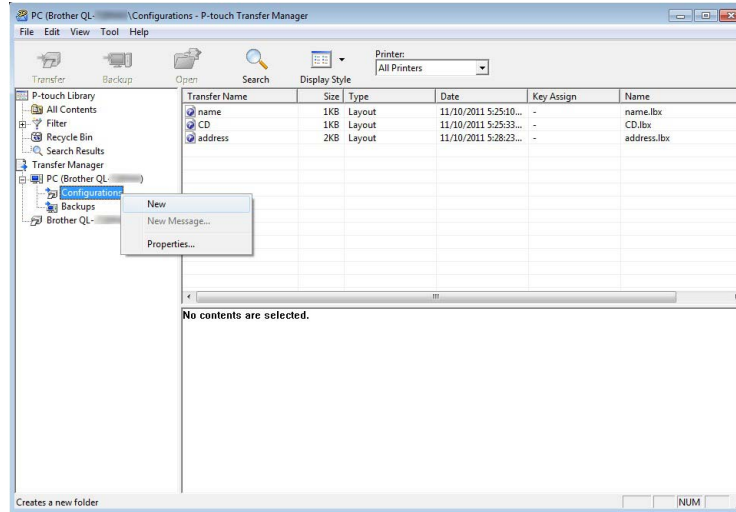

- Drag the template or other data that you want to transfer and place it in the new folder.

Transfer Function Specification

Data type	Maximum number of transferable items	Restriction details
Template	QL-810W: 99 QL-820NWB: 255	<ul style="list-style-type: none"> Each template can contain a maximum of 50 objects.
Database	QL-810W: 99 QL-820NWB: 99	<ul style="list-style-type: none"> Only *.csv files can be transferred. Each *.csv file can contain a maximum of 65000 records.
Image (transferred symbols)	QL-810W: 99 QL-820NWB: 255	<ul style="list-style-type: none"> Only *.bmp files can be transferred. Monochrome *.bmp files are recommended. The size limit is 720 × 720 pixels. Wide images may be cropped.

 **Note**

You can confirm the available space in the transfer file memory by printing the Printer Setting Report. For more information, see *Confirming the Label Printer Settings* on page 84.

See **[ROM FREE]** in the report for the available space ¹.

¹ The available space that appears in "ROM FREE: ***** byte" may be different from the actual available space.

You can view the templates and other data by selecting:

- The folder in the **[Configurations]** folder
- **[All Contents]**
- One of the categories under **[Filter]**, such as **[Layouts]**.

When transferring multiple templates or other data, drag all files you want to transfer and place them in the new folder.

Each file is assigned a key number (memory location in the Label Printer) when it is placed in the new folder.

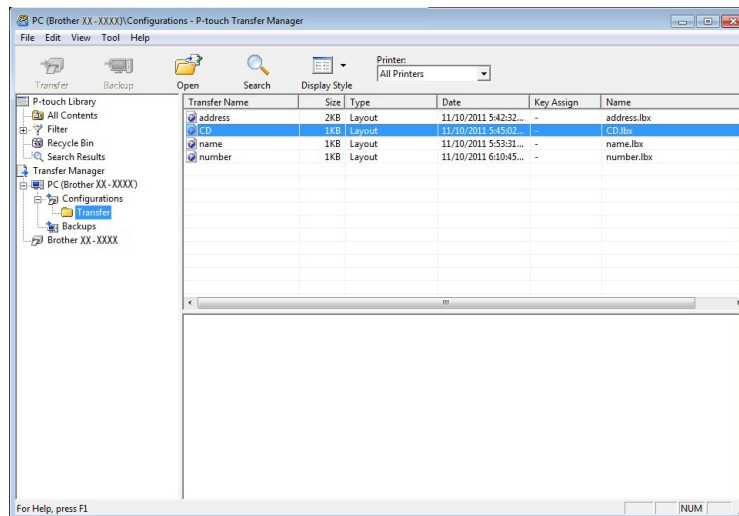

- To change the key number assigned to an item, right-click the item, select **[Key Assign]**, and then select the key number you want.

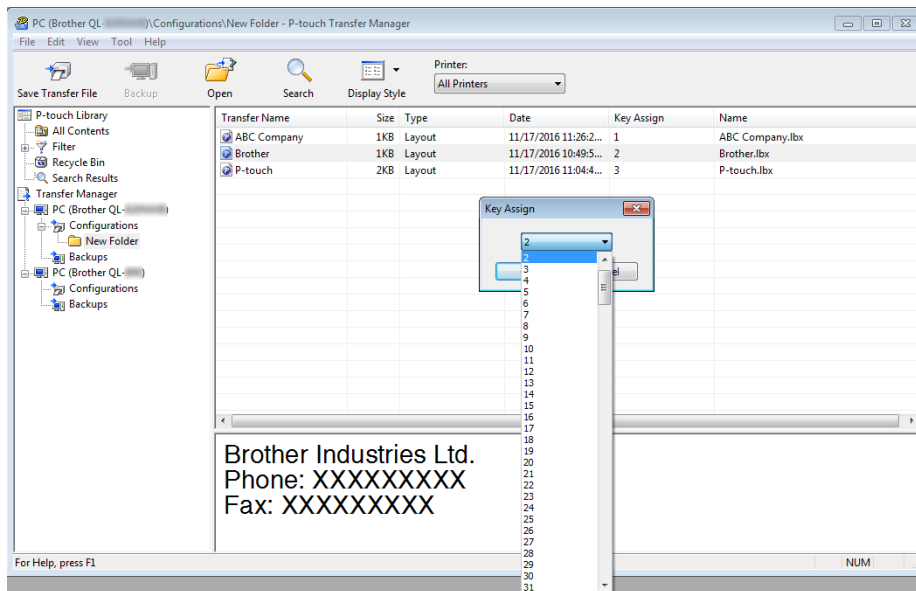

Note

- Except for the data in databases, all data transferred to the Label Printer is assigned a key number.
- If the template or other data transferred to the Label Printer has the same key number as another template already saved in the Label Printer, the new template will overwrite the old one. You can confirm the templates key number assignments saved in the Label Printer by backing up the templates or other data. For more information, see *Backing up Templates or Other Data Saved in the Label Printer* on page 131.
- If the Label Printer memory is full, remove one or more templates from the Label Printer's memory. For more information, see *Backing up Templates or Other Data Saved in the Label Printer* on page 131.

- To change the names of templates or other data that you want to transfer, click the item you want, and then type the new name. The number of characters used for the template names may be limited depending on the Label Printer model.

Note

The LCD (QL-820NWB only) displays the first 9 characters of the template file name.

- 7 Select the folder containing the templates or other data that you want to transfer, and then click **[Transfer]**. A confirmation message appears.

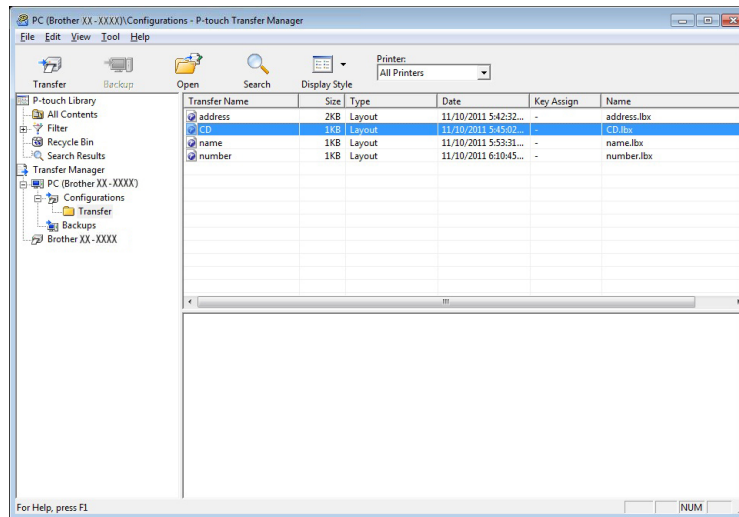

Note

- You can also transfer individual items to the Label Printer without adding them to a folder. Select the template or other data that you want to transfer, and then click **[Transfer]**.
- Multiple items and folders can be selected and transferred in one operation.

- 8 Click **[OK]**.

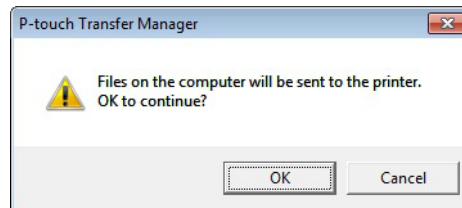

The selected items are transferred to the Label Printer.

Backing up Templates or Other Data Saved in the Label Printer

Use the following procedure to retrieve templates or other data saved in the Label Printer and save it on the computer.

❗ Important

- Backed up templates or other data cannot be edited on the computer.
- Depending on the Label Printer model, backed up templates or data may not be transferable between different models.

- 1 Connect the computer and the Label Printer and turn on the Label Printer. The Label Printer model name appears next to a printer icon in the folder view. If you select the Label Printer in the folder view, the current templates and other data stored in the Label Printer appear.
- 2 Select the Label Printer to back up from, and then click **[Backup]**. A confirmation message appears.

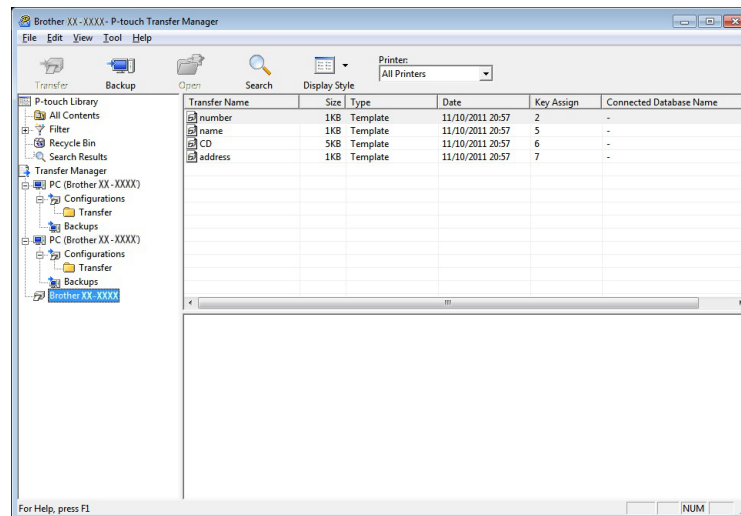

- 3 Click **[OK]**. A new folder is created under the Label Printer in the folder view. The folder name is based on the date and time of the backup. All of the Label Printer's templates and other data are transferred to the new folder and saved on the computer.

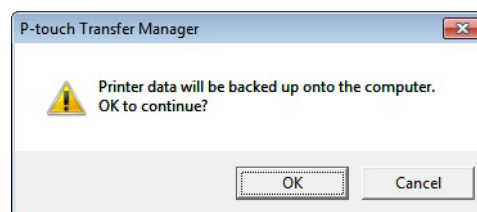

Deleting Label Printer Data

Use the following procedure to delete all templates or other data saved on the Label Printer.

- 1 Connect the computer and the Label Printer and turn on the Label Printer.
The Label Printer model name appears next to a printer icon in the folder view.
- 2 Right-click the Label Printer, and then select [**Delete All**].

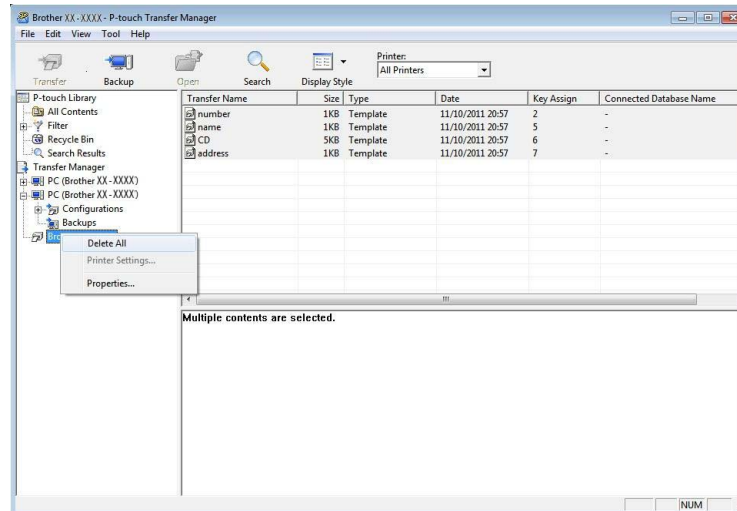

A confirmation message appears.

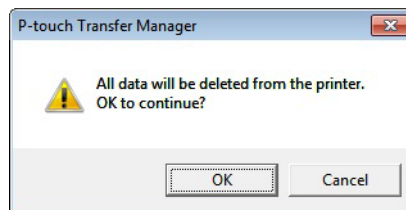

- 3 Click [**OK**].
All templates and other data saved in the Label Printer is deleted.

Creating Transfer Files and Transfer Package Files

You can use P-touch Transfer Manager to save template data, which was created using P-touch Editor, in the BLF or PDZ format. You can transfer these files in this format to a Label Printer over a network, from a computer or mobile device. You can also print files in BLF format from mass storage mode.

- 1 Create the template using P-touch Editor, and then transfer it to P-touch Transfer Manager. For more information, see *Transferring the Template to P-touch Transfer Manager* on page 123.
- 2 Without connecting the Label Printer to the computer, select [**Configurations**] in the P-touch Transfer Manager window, and then select the template to save.



Note

You can select multiple templates at the same time.

- 3 Click [**File**] - [**Save Transfer File**].

Important

The [**Save Transfer File**] button appears only if the Label Printer is disconnected from the computer or offline.



Note

- If you click [**Save Transfer File**] after selecting [**Configurations**], all templates in the folder are saved as the Transfer file (.blf) or Transfer Package file (.pdz).
 - You can combine multiple templates into a single Transfer file (.blf) or Transfer Package file (.pdz).
- 4 In [**Save as type**], select the template format you want, and then type in the name and save the template. Select the BLF format when printing using the mass storage mode or connecting your mobile device to the Label Printer using Wireless Direct or Wi-Fi, and select the PDZ format when connecting using Bluetooth.
The templates are saved as a Transfer file (.blf) or Transfer Package file (.pdz).

P-touch Library

This program allows you to manage and print P-touch Editor templates.

Starting P-touch Library

■ **For Windows Vista / Windows 7 / Windows Server 2008 / Windows Server 2008 R2:**

From the Start button, click [All Programs] - [Brother P-touch] - [P-touch Tools] - [P-touch Library 2.2].

■ **For Windows 8 / Windows 8.1 / Windows Server 2012 / Windows Server 2012 R2:**

Click [P-touch Library 2.2] on the [Apps] screen.

■ **For Windows 10:**

From the Start button, click [P-touch Library 2.2] under [Brother P-touch].

When P-touch Library starts, the Main window appears.

Main window

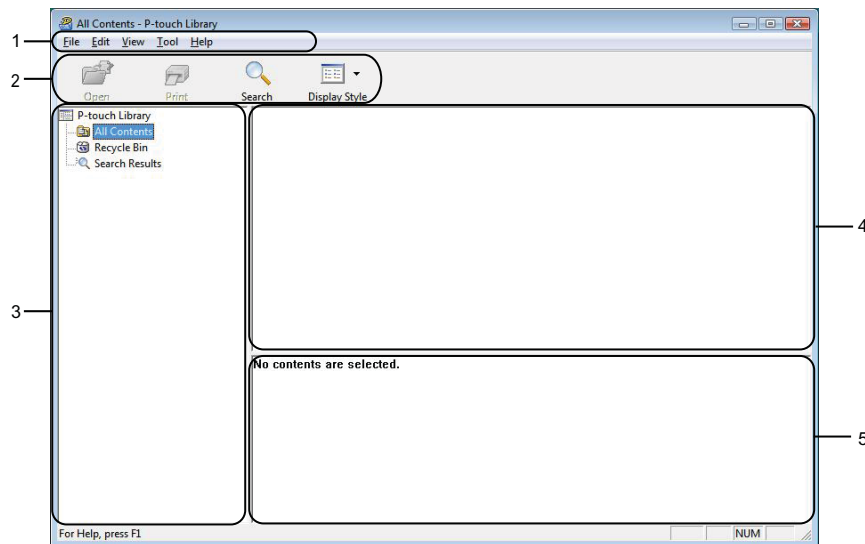

1 Menu Bar

Provides access to all available commands, which are grouped under each menu title ([File], [Edit], [View], [Tool], and [Help]) according to their functions.

2 Toolbar

Provides access to frequently used commands.

3 Folder List

Displays a list of folders. When you select a folder, the templates in the selected folder appear in the templates list.





4 Templates List

Displays a list of the templates in the selected folder.

5 Preview

Displays a preview of the templates selected in the templates list.

Explanations of the Toolbar Icons

Icon	Button name	Function
	Open	Opens the selected template.
	Print	Prints the selected template with the Label Printer.
	Search	Allows you to search for templates registered to P-touch Library.
	Display Style	Changes the file display style.

Opening and Editing Templates

Select the template you want to open or edit, and then click **[Open]**.

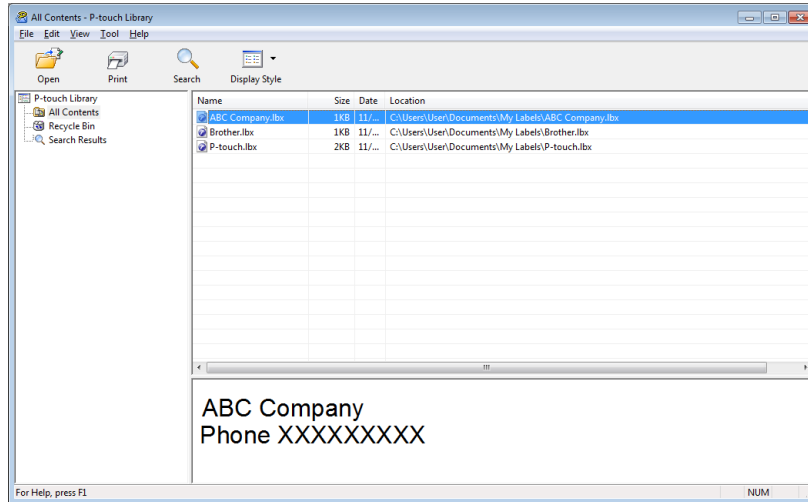

The program associated with the template starts so that you can edit the template.

Printing Templates

Select the template you want to print, and then click **[Print]**.

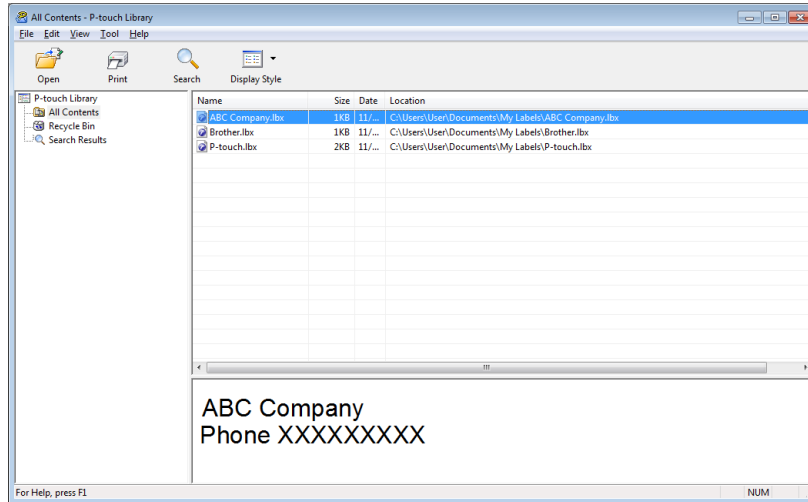

The connected Label Printer prints the template.

Searching for Templates

You can search for templates registered to P-touch Library.

- 1 Click **[Search]**.
The **Search** dialog box appears.

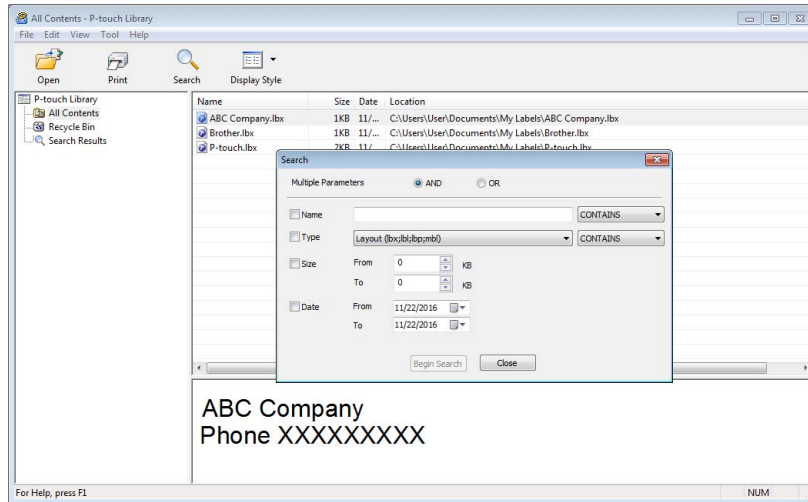

- 2 Specify the search criteria.
The following search criteria are available:

Settings	Details
Multiple Parameters	Determines how the program searches when multiple criteria are specified. If you select [AND] , the program searches for files that satisfy all of the criteria. If you select [OR] , the program searches for files that satisfy any of the criteria.
Name	Search for a template by specifying the file name.
Type	Search for a template by specifying the file type.
Size	Search for a template by specifying the file size.
Date	Search for a template by specifying the file date.

- 3 Click **[Begin Search]**.
The search begins.
The search result is displayed on the screen.

- 4 Close the **Search** dialog box.
To confirm the search results, click [**Search Results**] in the folder view.



Note

You can register templates to P-touch Library by dragging and dropping them into the [**All Contents**] folder or to the folder list. You can also configure P-touch Editor to register templates to P-touch Library automatically, using the following procedure:

- 1 From the P-touch Editor menu, select [**Tools**] - [**Options**].
 - 2 In the **Options** dialog box, click [**Registration Settings**] in the [**General**] tab.
 - 3 Select the timing for registering templates created with P-touch Editor, and then click [**OK**].
-

10

Transferring Templates with P-touch Transfer Express (Windows only)

You can transfer templates to the Label Printer using P-touch Transfer Express. First, the administrator creates a template, and then distributes it together with P-touch Transfer Express. You can then use P-touch Transfer Express to transfer the template directly to your Label Printer.

You can download the latest P-touch Transfer Express

[Select your region/country.] - [Downloads] - [Choose your product]

Important

- If you want to transfer a new template, make sure you specify a **[Key Assign]** number (in P-touch Transfer Manager) that is not currently used. If the specified **[Key Assign]** number is already being used, the existing template will be overwritten with the new one.
- This function requires a USB connection.

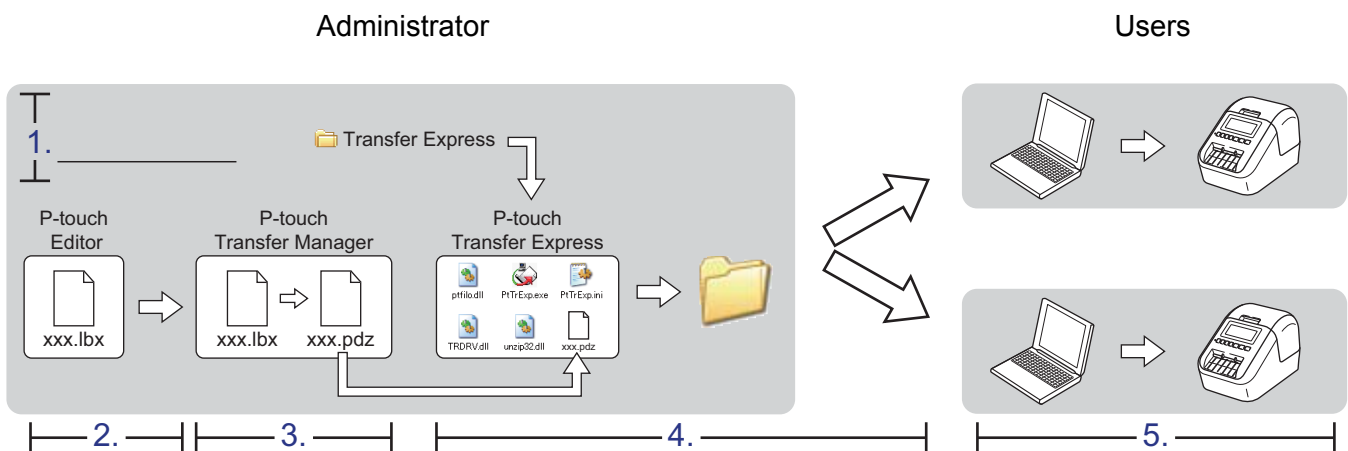

Preparing P-touch Transfer Express

The user must prepare P-touch Transfer Express for transferring templates to a Label Printer.

Important

- The printer driver must be installed before using Transfer Express.
- P-touch Transfer Express is available only in English.

1 You can download the latest P-touch Transfer Express

[Select your region/country.] - [Downloads] - [Choose your product]

2 Download Transfer Express to any location on the computer.

3 Decompress the downloaded file (.zip).

Transferring the Template to P-touch Transfer Manager

- 1 In P-touch Editor, open the template you want.
- 2 Click [File] - [Transfer Template] - [Transfer].

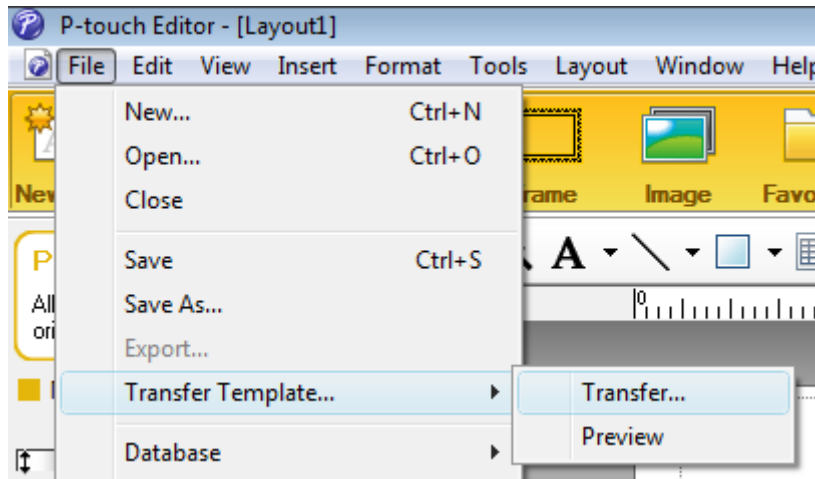

The template is transferred to P-touch Transfer Manager.
P-touch Transfer Manager automatically starts up.



Note

- **For Windows Vista / Windows 7 / Windows Server 2008 / Windows Server 2008 R2:**
The template can also be transferred to P-touch Transfer Manager by clicking the Start button - [All Programs] - [Brother P-touch] - [P-touch Tools] - [P-touch Transfer Manager 2.2] to start P-touch Transfer Manager, and then dragging the .ltx file to the P-touch Transfer Manager window.
- **For Windows 8 / Windows 8.1 / Windows Server 2012 / Windows Server 2012 R2:**
The template can also be transferred to P-touch Transfer Manager by clicking [P-touch Transfer Manager 2.2] on the [Apps] screen to start P-touch Transfer Manager, and then dragging the .ltx file to the P-touch Transfer Manager window.
- **For Windows 10:**
The template can also be transferred to P-touch Transfer Manager by clicking the Start button, then click [Brother P-touch] - [P-touch Transfer Manager 2.2] to start P-touch Transfer Manager, and then dragging the .ltx file to the P-touch Transfer Manager window.

Saving the Template as a Transfer Package File (.pdz)

To create a file in a format that can be used by P-touch Transfer Express, save the template as a Transfer Package file (.pdz).

- 1 In the folder view, select **[Configurations]**.

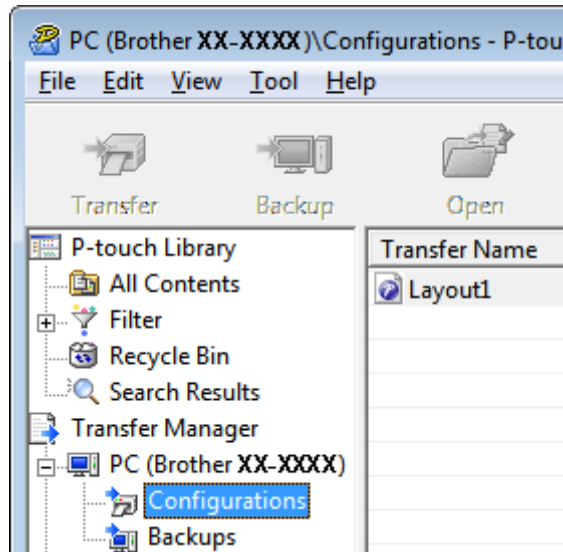

- 2 Select the templates you want to distribute.

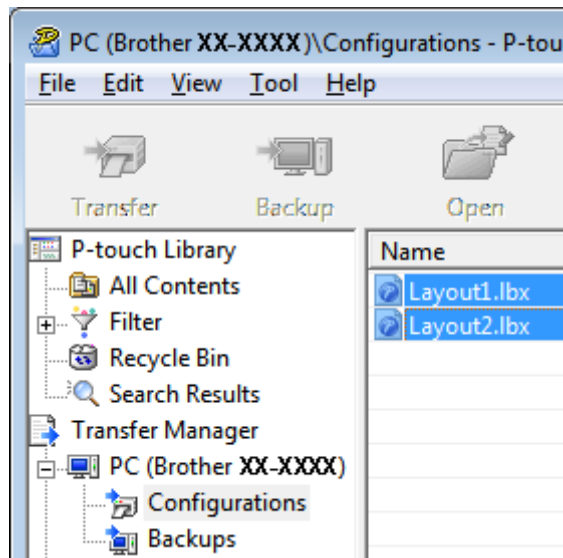

- 3 Click **[File]** - **[Save Transfer File]**.

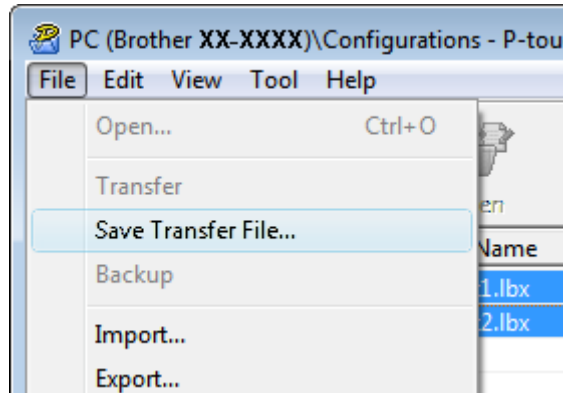

! Important

The **[Save Transfer File]** button appears only if the Label Printer is disconnected from the computer or offline.

Note

- If you click **[Save Transfer File]** after selecting **[Configurations]** or a created folder, all templates in the folder are saved as the Transfer Package file (.pdz).
- You can combine multiple templates into a single Transfer Package file (.pdz).

- 4 Type in the name, and then click **[Save]**.

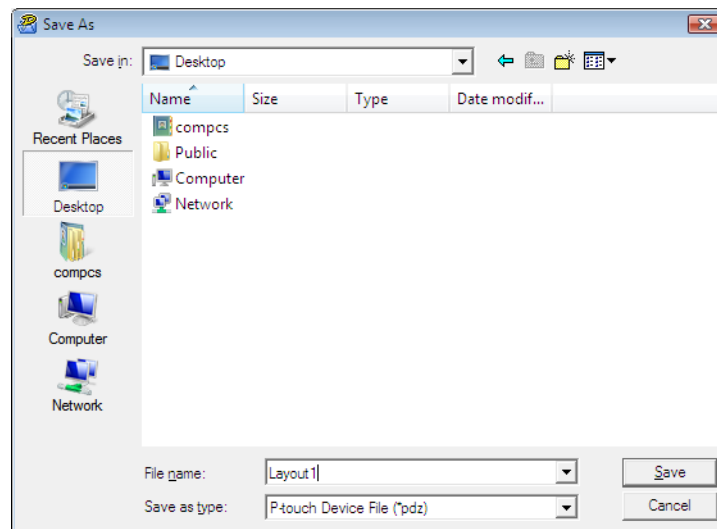

The template is saved as a Transfer Package file (.pdz).

Distributing the Transfer Package File (.pdz) and P-touch Transfer Express to the User



Note

If the user already has P-touch Transfer Express downloaded, it is not necessary for the administrator to send the Transfer Express folder to the user. In this case, the user can simply move the distributed Transfer Package file to the downloaded folder, and then double-click [**PtTrExp.exe**].

- 1 Move the Transfer Package file (.pdz) to the downloads folder.

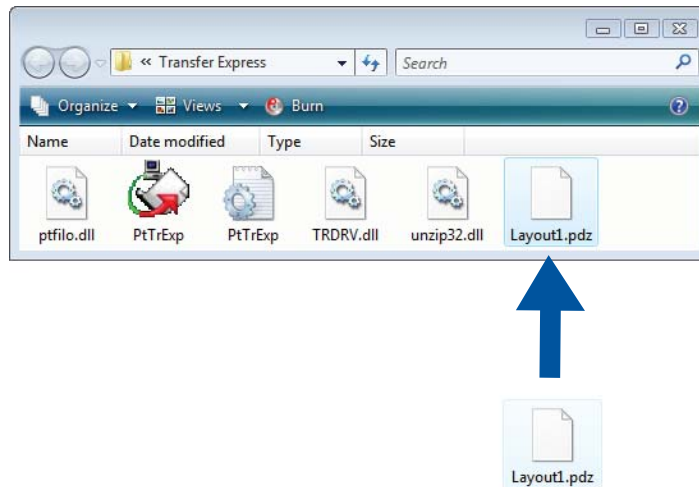

- 2 Distribute all files in the downloads folder to the user.

Transferring the Transfer Package File (.pdz) to Your Label Printer

Using the P-touch Transfer Express application received from the administrator, the user can transfer the Transfer Package file (.pdz) to the Label Printer.

❗ Important

Do not turn off the power when transferring templates.

- 1 Turn on the Label Printer.
- 2 Using a USB cable, connect the Label Printer to the computer.
- 3 Double-click [**PtTrExp.exe**], which was received from the administrator.
- 4 1 When there is a single Transfer Package file (.pdz) within the folder containing [**PtTrExp.exe**], click [**Transfer**].

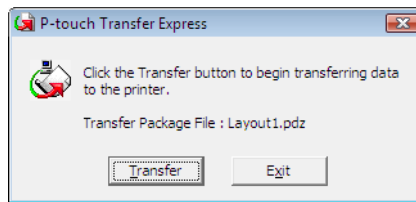

The transfer of the Transfer Package file begins.

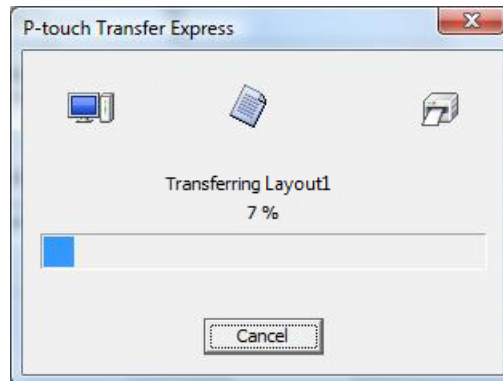

2 When there are either multiple or no Transfer Package files (.pdz) within the folder containing [PtTrExp.exe], click [Browse].

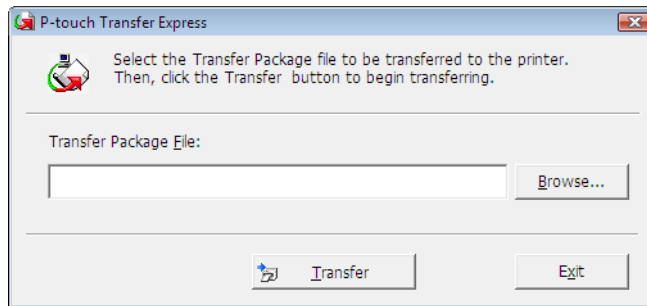

Select the Transfer Package file you want to transfer, and then click [Open].

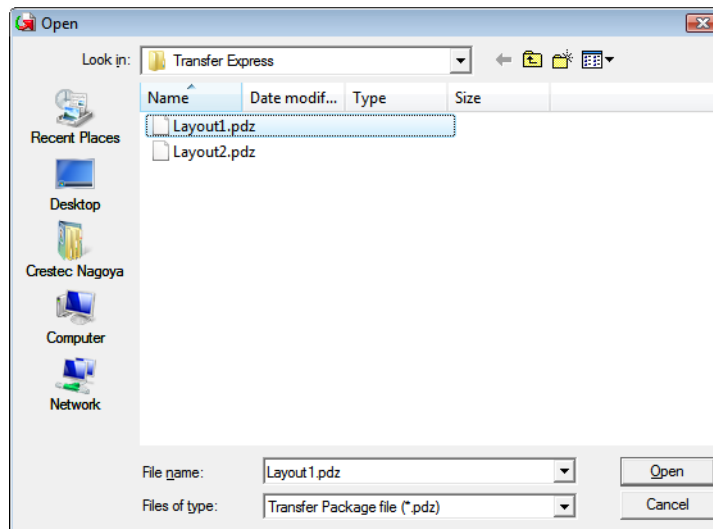

Click [Transfer].

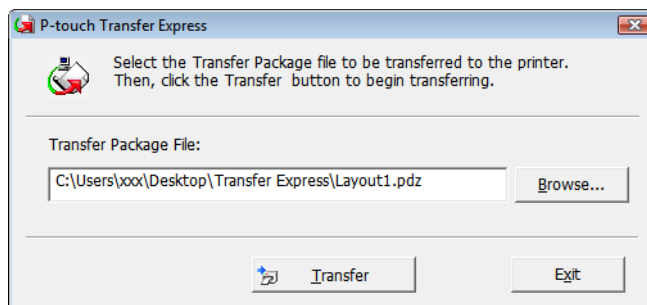

Click **[Yes]**.

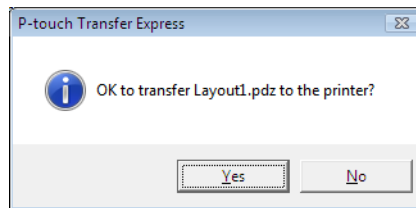

The transfer of the Transfer Package file begins.

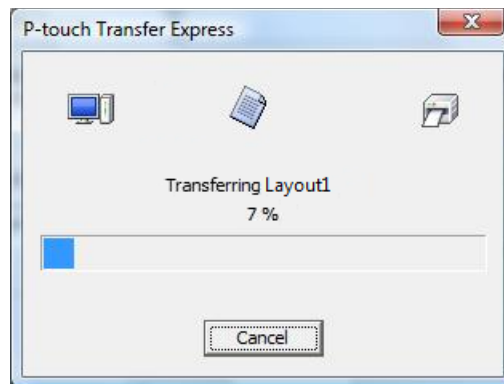

5 Click **[OK]**.

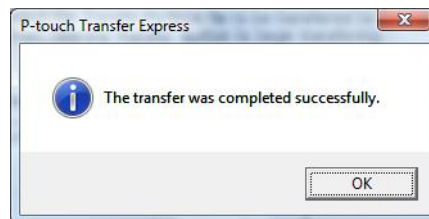

The transfer of the Transfer Package file is completed.

The software can be upgraded to the latest available version using the P-touch Update Software.



Note

- The actual software and the contents of this manual may differ.
- Do not turn off the power when transferring data or updating firmware.

Updating P-touch Editor and P-touch Address Book (Windows only)



Important

(Windows only) Before updating P-touch Editor and P-touch Address Book, install the printer driver.

For Windows



1 Start the P-touch Update Software.

■ For Windows Vista / Windows 7 / Windows Server 2008 / Windows Server 2008 R2:

Double-click the [P-touch Update Software] icon.



Note

The following method can also be used to start P-touch Update Software:

Click the Start button, and then select [All Programs] - [Brother P-touch] - [P-touch Update Software].

■ For Windows 8 / Windows 8.1 / Windows Server 2012 / Windows Server 2012 R2:

Click [P-touch Update Software] on the [Apps] screen or double-click [P-touch Update Software] on the desktop.

■ For Windows 10:

From the Start button, click [Brother P-touch] - [P-touch Update Software], or double-click [P-touch Update Software] on the desktop.



- 2 Click the **[Computer software update]** icon.

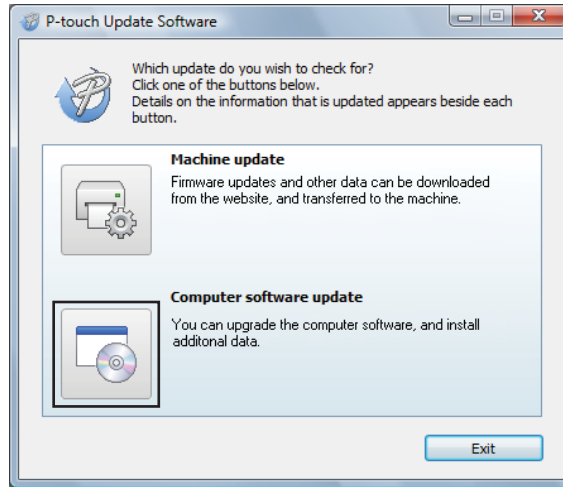

- 3 Select the **[Printer]** and **[Language]**, select the check boxes next to Cable Label Tool and P-touch Editor, and then click **[Install]**.

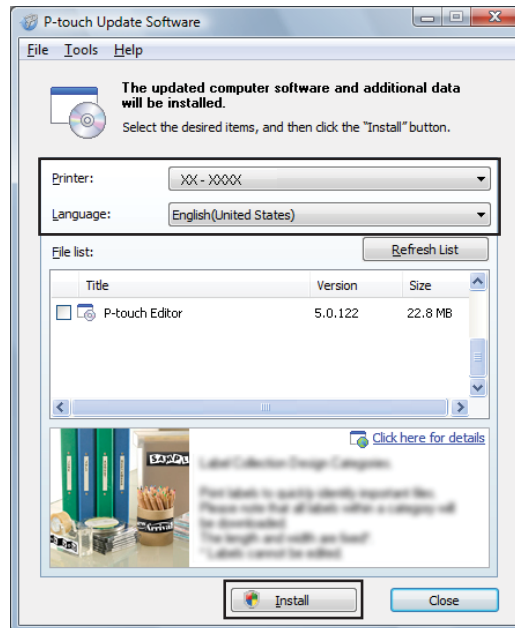

- 4 A message appears indicating that the installation has finished.

For Mac

- 1 Double-click the **[P-touch Update Software]** icon on the desktop.

 **Note**

The following method can also be used to start P-touch Update Software:

Double-click **[Macintosh HD] - [Applications] - [P-touch Update Software]**, and then double-click the **[P-touch Update Software]** application icon.



- 2 Click the **[Computer software update]** icon.

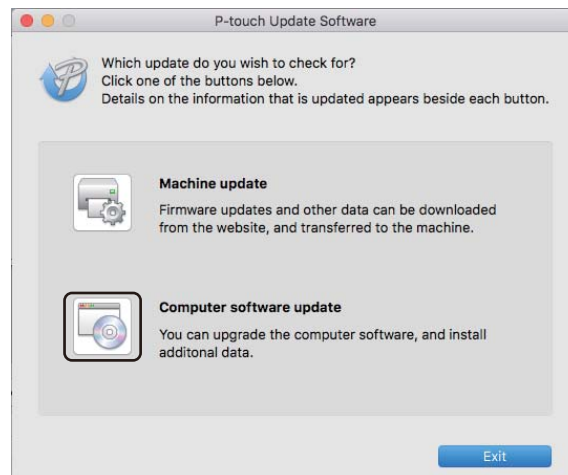

- 3 Select the **[Printer]** and **[Language]**, select the check box next to P-touch Editor, and then click **[Install]**.
- 4 A message appears indicating that the installation has finished.

Updating P-touch Editor Lite (Windows only) and the Firmware

❗ Important

- Before updating the firmware you must install the printer driver.
- Do not turn off the power when transferring data or updating firmware.
- If another application is running, exit the application.

For Windows

1 Turn on the Label Printer and connect the USB cable.

2 Start the P-touch Update Software.

■ **For Windows Vista / Windows 7 / Windows Server 2008 / Windows Server 2008 R2:**

Double-click the **[P-touch Update Software]** icon.

Note

The following method can also be used to start P-touch Update Software:

Click the Start button, and then select **[All Programs] - [Brother P-touch] - [P-touch Update Software]**.

■ **For Windows 8 / Windows 8.1 / Windows Server 2012 / Windows Server 2012 R2:**

Click **[P-touch Update Software]** on the **[Apps]** screen or double-click **[P-touch Update Software]** on the desktop.

■ **For Windows 10:**

From the Start button, click **[Brother P-touch] - [P-touch Update Software]**, or double-click **[P-touch Update Software]** on the desktop.



- 3 Click the **[Machine update]** icon.

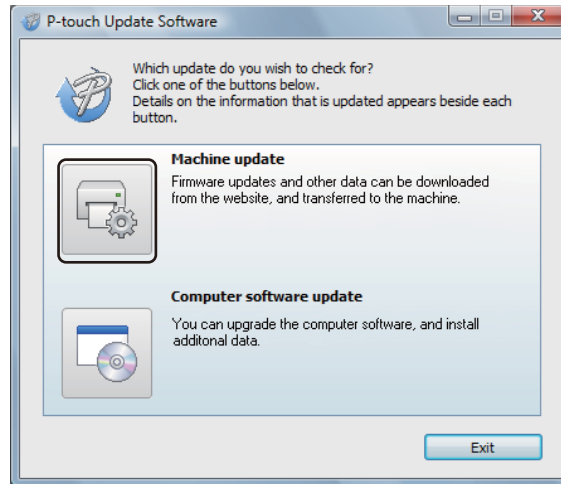

- 4 Select the **[Printer]**, make sure that **The machine is connected correctly.** message appears, and then click **[OK]**.

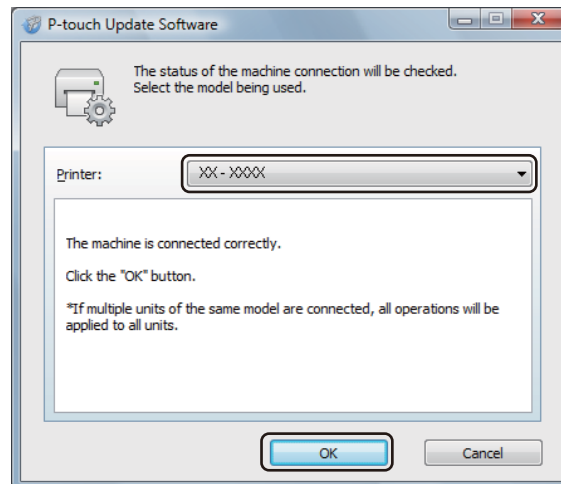

- 5 Select the **[Language]**, select the check box next to the firmware you want to update to, and then click **[Transfer]**.

! Important

Do not turn off the Label Printer or disconnect the cable during data transfer.

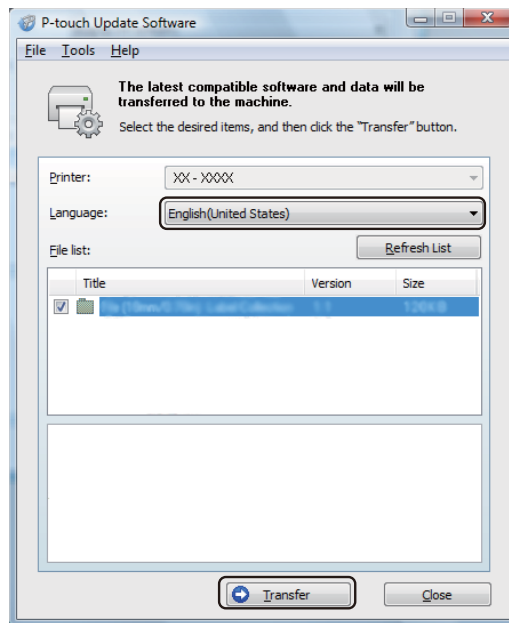

- 6 Check the content to be updated, and then click **[Start]** to begin the update. The firmware update begins.

! Important

Do not turn off the Label Printer or disconnect the cable during the update process.

For Mac

- 1 Turn on the Label Printer and connect the USB cable.
- 2 Double-click the **[P-touch Update Software]** icon on the desktop.

Note

The following method can also be used to start P-touch Update Software:

Double-click **[Macintosh HD]** - **[Applications]** - **[P-touch Update Software]**, and then double-click the **[P-touch Update Software]** application icon.



- 3 Click the **[Machine update]** icon.

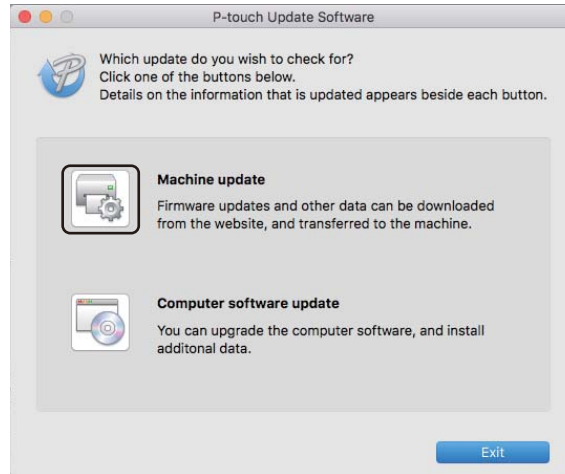

- 4 Select the **[Printer]**, make sure that **[The machine is connected correctly.]** message appears, and then click **[OK]**.
- 5 Select the **[Language]**, select the check box next to the firmware you want to update to, and then click **[Transfer]**.

! Important

Do not turn off the Label Printer or disconnect the cable during data transfer.

- 6 Check the content you want to update, and then click **[Start]** to begin the update. The firmware update begins.

Note

Do not turn off the Label Printer during the update process.



Network

Introduction	156
Changing Your Label Printer Network Settings	157
Web Based Management	160

12 Introduction

Network Features

Your Label Printer can be shared on an IEEE 802.11b/g/n wireless network or Ethernet 10BASE-T/100BASE-TX Auto Negotiation wired network (QL-820NWB only) using the internal network print server. The print server supports various functions and methods of connection on a network supporting TCP/IP, depending on the operating system you are running.

Changing Your Label Printer's Network Settings (IP Address, Subnet Mask and Gateway)

Using the BRAdmin Light Utility (Windows only)

The BRAdmin Light utility is designed for the initial setup of Brother network connectable devices. It can also search for Brother products in a TCP/IP environment, display the status, and configure basic network settings, such as the IP address.

Installing BRAdmin Light

- 1 Download the installer for the software and documents.
- 2 Double-click the downloaded file and follow the on-screen instructions to proceed with the installation. In the dialog box for selecting which items to install, select BRAdmin Light.



Note

- For more advanced Label Printer management, use the latest version of the Brother BRAdmin Professional utility available as a download
 - If using firewall, anti-spyware, or antivirus software, temporarily disable them. When you are sure that you can print, re-enable them.
 - The node name appears in the current BRAdmin Light window. The default node name of the print server in the Label Printer is "BRWxxxxxxxxxxxx" or "BRNxxxxxxxxxxxx". ("xxxxxxxxxxxx" is based on Label Printer's MAC Address / Ethernet Address.)
-

Setting the IP address, Subnet Mask and Gateway using BRAdmin Light

- 1 Start the BRAdmin Light utility.
 - **Windows Vista / Windows 7 / Windows Server 2008 / Windows Server 2008 R2**
Click [Start] - [All Programs] - [Brother] - [BRAdmin Light] - [BRAdmin Light].
 - **Windows 8 / Windows 8.1 / Windows Server 2012 / Windows Server 2012 R2**
Click the [BRAdmin Light] icon on the [Apps] screen.
 - **Windows 10**
From the Start button, click [BRAdmin Light] under [Brother].
- 2 BRAdmin Light will search for new devices automatically.

Changing Your Label Printer Network Settings

- 3 Double-click the unconfigured device.

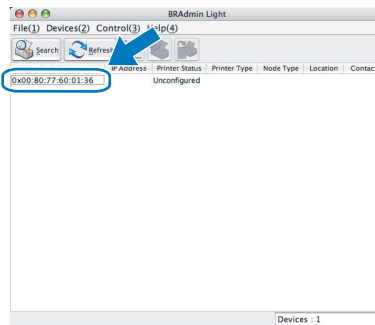

Note

If you do not use a DHCP/BOOTP/RARP server, the device appears as **[Unconfigured]** in the BRAdmin Light utility screen.

- 4 Select **[STATIC]** for **[Boot Method]**. Type the **[IP Address]**, **[Subnet Mask]**, and **[Gateway]** settings (if needed) for your print server.

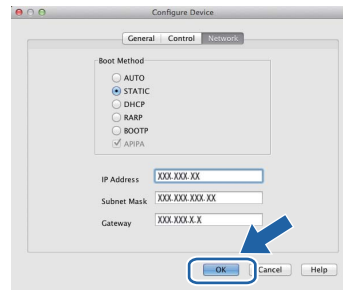

- 5 Click **[OK]**.
- 6 If you have set the IP address up correctly, the Brother print server appears in the device list.

Other Management Utilities

Your Label Printer can be used with the following management utilities in addition to the BRAdmin Light utility. You can change your network settings using these utilities.

Using Web Based Management (Web Browser)

A standard web browser can be used to change your print server settings using the HTTP (Hyper Text Transfer Protocol). For more information, see *Configuring the Printer Settings Using Web Based Management (Web Browser)* on page 161.

Using the BRAdmin Professional Utility (Windows only)

BRAdmin Professional is a utility for more advanced management of network connected Brother devices. This utility can search for Brother products on your network, and display the device status from a simple Explorer style window that changes color to represent the status of each device. You can configure network and device settings along with the ability to update device firmware from a Windows computer on your Local Area Network (LAN). BRAdmin Professional can also log activity of Brother devices on your network and export the log data.



Note

- Use the latest version of the BRAdmin Professional utility available as a download
 - If using firewall, anti-spyware, or antivirus software, temporarily disable them. When you are sure that you can print, re-enable them.
 - The node name appears in the current BRAdmin Professional window. The default node name is "BRWxxxxxxxxxxxx" or "BRNxxxxxxxxxxxx". ("xxxxxxxxxxxx" is based on Label Printer's MAC Address / Ethernet Address.)
-

Overview

You can use a standard web browser to manage a Label Printer on your network using HTTP. When using Web Based Management, the following operations are available:

- Displaying your Label Printer status information
- Changing network settings, such as TCP/IP information
- Displaying software version information of the Label Printer and print server
- Changing network and Label Printer configuration details



Note

We recommend Microsoft Internet Explorer 9/10/11 for Windows, Safari 8 or later for Mac.

Make sure JavaScript and cookies are always enabled in the browser you use.

To use Web Based Management, your network must use TCP/IP, and the Label Printer and computer must have a valid IP address.

Configuring the Printer Settings Using Web Based Management (Web Browser)

A standard web browser can be used to change your print server settings using the HTTP (Hyper Text Transfer Protocol).

- 1 In your browser's address bar, type the IP address of your Label Printer (or print server name).
For example: `http://192.168.1.2`



Note

If you have edited the hosts file on your computer or are using a Domain Name System, you can also type the DNS name of the print server. As the print server supports TCP/IP and NetBIOS, you can also type the NetBIOS name of the print server. The NetBIOS name is displayed on the printer settings page. The NetBIOS name assigned is the first 15 characters of the node name and by default it appears as "BRNxxxxxxxxxxx" where "xxxxxxxxxxx" is the Ethernet address.



- 2 You can now change the print server settings.



Note

Setting a password

We recommend setting a logon password to prevent unauthorized access to Web Based Management.

- 1 Click [**Administrator**].
 - 2 Type the password you want to use (up to 32 characters).
 - 3 Re-type the password in the [**Confirm new password**] field.
 - 4 Click [**Submit**].
The next time you access Web Based Management, type a password in the [**Login**] field, and then click .
- After configuring the settings, log off by clicking .

You can also set a password by clicking [**Please configure the password.**] on the printer's web page if you are not setting a logon password.



Appendix

Resetting the Label Printer	163
Maintenance	165
Troubleshooting	168
Product Specifications	183
Notes on Using P-touch Transfer Manager	185
Network Terms and Information	187
List of Barcodes for the P-touch Template Function	196
Using the Optional Battery Unit (Rechargeable Li-ion Battery included)	200
Using the Brother Barcode Scanner (Optional: PA-BR-001) (QL-820NWB only)	203

Reset the internal memory of your Label Printer to clear all saved label files, or if the Label Printer is not operating correctly.

Resetting All Settings to the Factory Settings Using the Label Printer Buttons (QL-810W only)

To reset the Label Printer, perform the following procedure.

- 1 Confirm that the Label Printer is turned off.
- 2 Press and hold the Power (⏻) and Cutter (✂) Buttons for more than three seconds. The Status LED lights in green.
- 3 Continue holding down the Power (⏻) Button, then the Status LED lights in orange, and meanwhile the Editor Lite LED flashes green at 0.5 second intervals, the Wi-Fi (📶) LED flashes blue at 0.5 second intervals.
 - Press the Cutter (✂) Button once to reset the network settings, the Status LED lights in orange.
 - Press the Cutter (✂) Button twice to reset the user data, the Wi-Fi (📶) LED lights in blue.
 - Press the Cutter (✂) three times to reset all the settings and device settings to the factory settings, the Editor Lite LED lights in green.
- 4 Release the Power (⏻) Button. The Status LED flashes orange for four times and lights in orange, the Wi-Fi (📶) LED flashes blue for four times and lights in blue, meanwhile the Editor Lite LED flashes green for four times and lights in green.

Resetting Data Using the LCD menu (QL-820NWB only)

You can reset the following settings using the LCD menu:

- Printer settings
- User setting
- Network settings

For more information, see *LCD Settings* on page 12.

Resetting Data Using the Printer Setting Tool

You can use the Printer Setting Tool from a computer to perform the following operations for the Label Printer:

- Deleting the templates and databases
- Resetting communication settings
- Resetting printer settings to factory settings

For more information, see *Changing the Label Printer Settings* on page 37.

We recommend cleaning your Label Printer on a regular basis to maintain its correct performance.

**Note**

Always disconnect the AC Adapter before cleaning the Label Printer.

Cleaning the Exterior of the Unit

Wipe any dust and marks from the main unit using a soft, dry cloth.

Use a cloth slightly damp with water on difficult to remove marks.

**Note**

Do not use paint thinner, benzene, alcohol or any other organic solvent.

These may deform or damage the case of your Label Printer.

Cleaning the Print Head

The DK Roll (thermal recording paper type) used with the machine is designed to clean the print head automatically. When the DK Roll passes the print head during printing and label feeding, the print head is cleaned.

Cleaning the Roller

Clean the roller using the Cleaning Sheet (available separately).

The Label Printer contains only one Cleaning Sheet.

**Note**

When cleaning the roller, be sure to use the Cleaning Sheet supplied exclusively for this Label Printer. If using other Cleaning Sheets, the surface of the roller may be damaged and may cause a malfunction.

- 1 Turn off the power to the Label Printer.
- 2 Hold the printer by the front and firmly lift the DK Roll Compartment Cover to open it.



- 3 Remove the DK Roll.

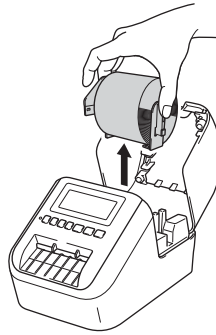

Note

Be sure to remove the DK Roll before cleaning the roller. The roller cleaning function will not operate correctly if the DK Roll is not removed.

- 4 Remove part (B) of the Cleaning Sheet.
Insert edge (A) of the Cleaning Sheet into the printing unit.



Note

The printed side of the Cleaning Sheet should be facing upwards.

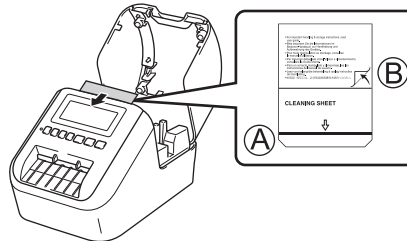

- 5 Close the DK Roll Compartment Cover and turn on the Label Printer.
- 6 Press the Feed (↑) Button (QL-810W) or the Cutter (✂) Button (QL-820NWB) for more than one second.
The Cleaning Sheet is ejected.
The adhesive side of the Cleaning Sheet removes any stains or dust on the roller.



Note

- If the Cleaning Sheet is not ejected, press and hold the Feed (↑) Button (QL-810W) or the Cutter (✂) Button (QL-820NWB) until the Cleaning Sheet is ejected.
- Dispose of the Cleaning Sheet after use.

Cleaning the Label Outlet

If a label causes the machine to jam due to adhesive residue attached to the label outlet, clean the label outlet with a cloth.

Use a slightly damp cloth on difficult to remove adhesive, if necessary.

Overview

This chapter explains how to resolve typical problems you may encounter when using the Label Printer. If you have any problems with the Label Printer, first make sure you have performed the following tasks correctly:

- Connect the Label Printer to an AC power outlet or install the battery. For more information, see *Connecting the AC Adapter* on page 7.
- Remove all protective packaging from the Label Printer.
- Install and select the correct printer driver. For more information, see *Installing the Software and Printer Drivers to a Computer* on page 22.
- Connect the Label Printer to a computer or mobile device. For more information, see *Connecting the Label Printer to a Computer* on page 23.
- Close the DK Roll Compartment Cover completely.
- Insert a DK Roll correctly. For more information, see *Loading the DK Roll* on page 5.

If you still have problems, read the troubleshooting tips in this chapter for help. If, after reading this chapter, you are unable to resolve your problem

Printing Problems

Problem	Solution
The Label Printer does not print, or a printing error is received.	<ul style="list-style-type: none"> • Is the cable loose? Check that the cable is connected securely. • Is the DK Roll installed correctly? If not, remove the DK Roll and reinstall it. • Is there enough roll remaining? Check that there is enough roll remaining. • Is the DK Roll Compartment Cover open? Check that the DK Roll Compartment Cover is closed. • Has a print error or transmission error occurred? Turn off the Label Printer and then turn it on again. If there is still a problem, contact your Brother dealer. • If the Label Printer is connected via a USB hub, try connecting it directly to the computer. If not, try connecting it to another USB port. • If using P-touch Editor, select the DK Roll size in [Paper Type] (Windows) / [Print Media] (Mac) drop-down list.
The Status LED is not lit.	<ul style="list-style-type: none"> • Is the AC Adapter inserted correctly? Check that the AC Adapter is inserted. If it is inserted correctly, try plugging it into another AC power outlet.
The printed label contains streaks or poor quality characters, or the label is not fed correctly.	<ul style="list-style-type: none"> • Is the print head or roller dirty? While the print head generally remains clean under normal use, lint or dirt from the roller may become stuck on the printer head. If this occurs, clean the roller. For more information, see <i>Cleaning the Roller</i> on page 165.
A data transmission error appears on the computer.	<ul style="list-style-type: none"> • Is the Label Printer in cooling mode (the Status LED is flashing in orange)? Wait until the Status LED stops flashing and then try printing again.
Labels are jammed in the cutter.	<ul style="list-style-type: none"> • Contact Brother Customer Service.
The label is not ejected correctly after printing.	<ul style="list-style-type: none"> • Check that the Label Output Slot is not blocked. • Check that the DK Roll is set correctly by removing the DK Roll and reinstalling it. • Ensure that the DK Roll Compartment Cover is closed correctly.
I want to cancel the current printing job.	<ul style="list-style-type: none"> • Make sure that the Label Printer is On, and press Power (⏻) Button.
The print quality is poor.	<ul style="list-style-type: none"> • Is there dirt or lint on the roller preventing it from rolling freely? Clean the roller using the Cleaning Sheet available separately. For more information, see <i>Cleaning the Roller</i> on page 165.
After replacing the Roll while the Add-In feature was activated, the layout style was not updated.	<ul style="list-style-type: none"> • Close P-touch Editor to exit the Add-In, and then reactivate the Add-In.
The P-touch Add-In icon is not displayed in Microsoft Word.	<ul style="list-style-type: none"> • Is Microsoft Word started up from Microsoft Outlook? • Is Microsoft Word chosen as the default editor for Microsoft Outlook? Due to program limitations, the Microsoft Word Add-In does not work with the above settings. Exit Microsoft Outlook, and restart Microsoft Word.

Problem	Solution
Cutter error	<p>If a cutter error occurs, keep the DK Roll Compartment Cover closed and press the Power (⏻) Button. The cutter moves back to the normal position and the Label Printer turns off automatically.</p> <p>Make sure the Label Printer is Off and remove any jammed labels. If you need further assistance, contact Brother Customer Service.</p>
I want to reset the Label Printer.	<p>You can reset the Label Printer using the Printer Setting Tool from a computer. For more information, see <i>Changing the Label Printer Settings</i> on page 37.</p> <p>For QL-810W</p> <p>You can reset the Label Printer using the Printer Buttons. For more information, see <i>Resetting All Settings to the Factory Settings Using the Label Printer Buttons (QL-810W only)</i> on page 163.</p> <p>For QL-820NWB</p> <p>You can reset the Label Printer using the LCD menu. For more information, see <i>LCD (QL-820NWB only)</i> on page 11.</p>



Problem	Solution
<p>When printing via the USB cable, the Label Printer repeatedly pauses and then continues printing.</p>	<ul style="list-style-type: none"> Is the Label Printer set for sequential printing? If so, set print mode to buffered printing. <p>For Windows Vista / Windows Server 2008:</p> <p>Open printer properties from [Control Panel] - [Hardware and Sound] - [Printers], click the Label Printer you want, and select [Select printing preferences].</p> <p>Click the [Other] tab and select the option [After one page of data is received].</p> <p>For Windows 7 / Windows 8 / Windows 8.1 / Windows Server 2008 R2 / Windows Server 2012 / Windows Server 2012 R2:</p> <p>Open printer properties from [Devices and Printers], right-click the Label Printer you want, and select [Printing Preference]. Click the [Other] tab and select the option [After one page of data is received].</p> <p>For Windows 10:</p> <p>Open printer properties from [Control Panel] - [Hardware and Sound] - [Devices and Printers], right-click the Label Printer you want, and select [Printing Preference].</p> <p>Click the [Other] tab and select the option [After one page of data is received].</p> <ul style="list-style-type: none"> An alternative solution is to disconnect the LAN cable until USB printing is completed. (QL-820NWB only) <div data-bbox="818 1094 1287 1619" data-label="Image"> </div> <p style="text-align: center;">For Windows</p>

Problem	Solution
<p>Printed barcodes cannot be read.</p>	<ul style="list-style-type: none"> ■ Print labels so that barcodes are aligned with the print head as shown below: <div data-bbox="889 394 1209 556" style="text-align: center;"> </div> <ol style="list-style-type: none"> 1 Print head 2 Barcodes 3 Printing orientation <ul style="list-style-type: none"> ■ Try using another scanner. ■ We recommend printing the Barcode with Print Quality options set to [Give priority to print quality] (except for 2-color printing). <p>For Windows Vista</p> <p>To display the [Quality] options, open the printer properties by clicking the Start button - [Control Panel] - [Hardware and Sound] - [Printers], right-clicking the Label Printer you want to set up, and then clicking [Printing Preferences].</p> <p>For Windows 7</p> <p>To display the [Quality] options, open the printer properties by clicking the Start button - [Devices and Printers], right-clicking the Label Printer you want to set up, and then clicking [Printing Preferences].</p> <p>For Windows 8 / Windows 8.1</p> <p>To display the [Quality] options, open the printer properties by clicking [Control Panel] in the [Apps] screen - [Hardware and Sound] - [Devices and Printers], right-clicking the Label Printer you want to set up, and then clicking [Printing Preferences].</p> <p>For Windows 10</p> <p>To display the [Quality] options, open the printer properties by clicking the Start button - [Settings] - [Devices] - [Printers & scanners] - [Devices and Printers], right-clicking the Label Printer you want to set up, and then clicking [Printing Preferences].</p> <p>For Mac</p> <p>To change the Print Quality options, open the Print dialog box and choose [Basic] from the print options pop-up menu.</p>
<p>Lines appear in areas with a high red density level.</p>	<ol style="list-style-type: none"> 1 Remove the DK Roll from the Label Printer. 2 Close the DK Roll Compartment Cover completely. 3 Press and hold the Editor Lite Button (QL-810W) or Cancel Button (QL-820NWB) for more than five seconds. Wait while the platen roller rotates. 4 When the platen roller stops rotating, load the DK Roll. <p>The roller will rotate for about 40 seconds.</p>

Problem	Solution
<p>I want to feed the label.</p>	<p>For QL-810W Press the Feed (↑) Button for one second.</p> <p>For QL-820NWB Press the Cutter (✂) Button for one second, or press the Menu Button to select [Feed Start] from [Feed] menu. [Die-Cut Feed Setting] from [Feed] menu sets the length of fed label when using a die-cut label.</p>

Network Setup Problems

Problem	Solution
You are using security software	<ul style="list-style-type: none"> ■ Confirm your settings in the installation dialog box. ■ Allow access when the security software alert message appears during the Label Printer installation.
Your security settings (SSID/Network Key) are incorrect	<p>Recheck and select the correct security settings.</p> <ul style="list-style-type: none"> ■ The manufacturer's name or model number of the wireless access point/router may be used as the default security settings. ■ See the instructions supplied with your wireless access point/router for information on how to find the security settings. ■ Ask the wireless access point/router manufacturer or ask your Internet provider or network administrator.
Your Label Printer cannot connect to the host device using Wi-Fi or Bluetooth.	<ul style="list-style-type: none"> ■ Move your Label Printer within about 3.3 feet (one meter) of the mobile device when you configure the Wi-Fi network settings. ■ Move your Label Printer to an obstruction-free area.
Your Label Printer cannot print using Wi-Fi or Bluetooth.	<ul style="list-style-type: none"> ■ If a wireless computer, Bluetooth-equipped device, microwave oven, digital cordless phone, or other device is near your Label Printer or the wireless access point/router, move the device away from your Label Printer or wireless access point/router.
There are obstructions (walls or furniture, for example) between your Label Printer and the mobile device	<p>Move your Label Printer to an obstruction-free area.</p>
A wireless computer, Bluetooth supported device, microwave oven or digital cordless phone is near the Label Printer or the wireless access point/router	<p>Move other devices away from the Label Printer.</p>
You are using MAC Address filtering	<p>You can confirm the MAC address by printing the Printer Settings Report. For more information, see <i>Confirming the Label Printer Settings</i> on page 84.</p> <p>You can confirm the MAC address by confirming the [Infrastructure Mode] on the LCD (QL-820NWB only). For more information, see <i>WLAN Status</i> on page 19.</p>
Your wireless access point/router is in stealth mode (not broadcasting the SSID)	<ul style="list-style-type: none"> ■ You must type the correct SSID name during the installation or when using the Printer Setting Tool. ■ Check the SSID name in the instructions supplied with your wireless access point/router and reconfigure the Wi-Fi settings.

Problem	Solution
<p>Your Label Printer is not connected correctly to the network</p>	<ul style="list-style-type: none"> ■ Check that the Label Printer is in the mode you want to connect to. ■ If the Label Printer is still not connected, please try the following. <ul style="list-style-type: none"> • For Wi-Fi connection <p>For QL-810W</p> <p> (flashes once every three seconds): The network is connected incorrectly, and the Wi-Fi settings must be reconfigured.</p> <p>For QL-820NWB</p> <p>: Your Label Printer is searching for the network.</p> <ul style="list-style-type: none"> • For Wireless Direct <p>For QL-810W</p> <p>Search the Label Printer from the Wi-Fi device.</p> <p>For QL-820NWB</p> <p>If the Wireless Direct icon is displayed on the LCD, search the Label Printer from the device you want to connect.</p> <ul style="list-style-type: none"> • For Wired LAN (QL-820NWB only) <p>Check that the LAN cable is connected correctly.</p> <ul style="list-style-type: none"> • For Bluetooth (QL-820NWB only) <p>If the Bluetooth icon is displayed on the LCD, search the Label Printer from the device you want to connect.</p>
<p>I have checked and tried all of the above, but still cannot complete the Wi-Fi/Bluetooth settings</p>	<p>Turn off the Label Printer, and then turn it on again. Then, try and configure the Wi-Fi and Bluetooth settings again.</p>
<p>Your Label Printer is not connected if the Bluetooth connection with an Apple device (iPad, iPhone, or iPod touch) (QL-820NWB only) is lost.</p>	<p>Turn On the Auto Reconnect function.</p> <p>You can set it from the Printer Setting Tool or the Menu Button. For more information, see <i>Bluetooth</i> on page 19 or <i>Changing the Label Printer Settings</i> on page 37.</p>

Label Printer Cannot Print over the Network Label Printer Is Not Found on the Network Even after Successful Installation

Problem	Solution
You are using security software	See <i>Security Software Problems</i> on page 176.
Your Label Printer is not assigned with an available IP address	<ul style="list-style-type: none"> ■ Confirm the IP address and the Subnet Mask. Verify that both the IP addresses and Subnet Masks of your computer and your Label Printer are correct and located on the same network. For more information on how to verify the IP address and the Subnet Mask, ask the network administrator. ■ Confirm your IP address, Subnet Mask and other network settings using the Printer Setting Tool. For more information, see <i>Changing the Label Printer Settings</i> on page 37.
Your previous printing job failed	<ul style="list-style-type: none"> ■ If the failed printing job is still in your computer's print queue, delete it. For example, when using Windows 7: , [Devices and Printers] and select the Label Printer from [Printers and Faxes]. Double-click the Label Printer's icon, and then select [Cancel All Documents] in the [Printer] menu.
I have checked and tried all of the above, but my Label Printer does not print	Uninstall the printer driver and the software, and then reinstall them.

Security Software Problems

Problem	Solution
You did not select to allow access when the Security Alert dialog box appeared during either the standard installation, BRAdmin Light installation, or when printing	If you did not select to allow access when the Security Alert dialog box appeared, the firewall function of your security software may be blocking access. Some security software may block access without displaying a Security Alert dialog box. To allow access, refer to your security software instructions or ask the manufacturer.
Incorrect port numbers are being used for the Brother network features	<p>The following port numbers are used for Brother network features:</p> <ul style="list-style-type: none"> ■ BRAdmin Light – Port number 161 / Protocol UDP <p>For more information on how to open the port, refer to your security software instructions or ask the manufacturer.</p>

Checking the Operation of Network Devices











Problem	Solution
Your Label Printer and wireless access point/router are not turned on	Make sure you have performed all of the tasks on page 168.
I do not know my Label Printer network settings, such as the IP address	Check the Printer Setting Tool. For more information, see <i>Changing the Label Printer Settings</i> on page 37.

Version Information



















Problem	Solution
I do not know the version number of the firmware for the Label Printer.	<p>You can use the following procedure.</p> <p>For QL-810W</p> <ol style="list-style-type: none"> 1 Turn your Label Printer on. 2 Press and hold the Cutter (>⌂) Button for several seconds to print the report. (Use 2.4" (62 mm) DK Roll) <p>For QL-820NWB</p> <ol style="list-style-type: none"> 1 Turn your Label Printer on. 2 Press the Menu, ▲, or ▼ Button to select the [Information] menu, and then press the OK Button. 3 Select [Print Configuration] using ▲ or ▼, and then press the OK Button. 4 Select [All], [Usage Log], [Printer Setting] or [Transfer Data] using ▲ or ▼ Button, and then press the OK Button to print the report.
I want to confirm whether I am using the latest version of the software.	<p>Use the P-touch Update Software to confirm whether you have the latest version.</p> <p>For more information about the P-touch Update Software, see <i>How to Update P-touch Software</i> on page 148.</p>

LED Indications







The indicators light and flash to indicate the Label Printer's status.

-  or  or  or  Indicator is lit in the color shown
-  or  or  or  Indicator is flashing in the color shown
-  Indicator can be off, lit or flashing in any color
-  Indicator is off







QL-810W



Status LED	Editor Lite LED	Wi-Fi LED	Battery LED	Condition
				Power Off
				Power On
				Feeding mode
				Printing mode
				Forward/reverse roller rotation mode
				Cutting mode
				Cleaning mode
				WLAN is on and connected.
		 (Once for 1 second)		WPS setting mode
		 (Once for 3 seconds)		WLAN is on, but not connected.
				WLAN Off
		P-touch Editor Lite mode		
				Print preparation mode
				Canceling job
				Receiving data from the computer
				Transferring data

Status LED	Editor Lite LED	Wi-Fi LED	Battery LED	Condition
				The DK Roll Compartment Cover is open. Close the DK Roll Compartment Cover correctly.
		 (Once for 1 second)		Resetting mode
				System OFF mode The Cutter (✂) Button is pressed once in resetting mode.
				<ul style="list-style-type: none"> Continuously: The printer is in cooling mode. Three times: The printer is being discovered by another device.
				Data overwrite mode
				The Cutter (✂) Button is pressed three times in resetting mode.
				The Cutter (✂) Button is pressed twice in resetting mode.
				Boot mode
 (Once for 2 seconds)				End of DK Roll
				Feed error
				Transmission error
				Database search error
				Access point search error
				Access point connection error
				Security error
				No template selected
				The DK Roll Compartment Cover is opened while the Label Printer is in use.
				No media error
				Incorrect media error
				Communication command error
Two-color media high resolution printing error				
				The battery is charging.
				<ul style="list-style-type: none"> If the orange light flashes once every second, the battery needs recharging. If the orange light flashes twice every 4 seconds, the battery power is low. If the orange light flashes once every 4 seconds, the battery power is half.
				The battery is fully charged.

Status LED	Editor Lite LED	Wi-Fi LED	Battery LED	Condition
 (Twice for 2 seconds)				Cutter error
				System error

QL-820NWB

Status LED	Condition
	Power Off
	Power On
	Feeding Mode
	Printing Mode
	Mass storage mode
	Forward/reverse roller rotation mode
	Cutting Mode
	Cleaning Mode
	Initializing mode
	Print preparation mode
	Canceling job
	Receiving data from the computer
	Transferring data
	Data overwrite mode
	<ul style="list-style-type: none"> The DK Roll Compartment Cover is open. Close the DK Roll Compartment Cover correctly. System OFF mode
	Cooling mode
	Fixing IP address mode
	Boot mode

Status LED	Condition
 (Once for 2 seconds)	End of DK Roll
	Feed error
	Transmission error
	Database search error
	Access point search error
	Access point connection error
	Security error
	No template selected
	The DK Roll Compartment Cover is opened while the Label Printer is in use.
	No media error
	Incorrect media error
	Communication command error
	Two-color media high resolution printing error
 (Twice for 2 seconds)	Cutter error
	Mass storage error
	System error

Troubleshooting

Problem	Solution
Received data in buffer	<p>Print data is saved in the buffer. If the Label Printer has not received the complete data, printing will not start.</p> <p>Turn off the Label Printer, and then turn it on again.</p>
Head is cooling down	<p>The thermal head is too hot.</p> <p>The Label Printer stops and resumes printing only after the thermal head has cooled down. The head may become too hot if you are printing a large number of labels.</p> <p>When the thermal head becomes too hot, it may produce imaging outside the print area. To avoid or delay overheating, make sure the Label Printer has adequate ventilation and is not located in an enclosed space.</p> <p>If the Label Printer must cool down because it overheated due to the type of DK Roll you are using or the contents of the label, printing may take longer than usual.</p> <p> Note</p> <p>This condition may occur more often when the Label Printer is used at high altitude (more than 10,000 ft (3,048 m)) due to a lower air density available to cool the Label Printer.</p>
Label Printer is in boot mode	<p>To resolve the issue, contact your Brother dealer or Brother Customer Service for assistance.</p>
DK Roll errors	<p>Check the following:</p> <ul style="list-style-type: none"> • You are using the correct DK Roll. • There are enough labels remaining. • The DK Roll is installed correctly.
I want to reset an error	<p>To reset an error:</p> <ol style="list-style-type: none"> 1 Open the DK Roll Compartment Cover, and then close it. 2 If the error is not reset, press the Cutter (✂) Button. 3 If the error is not reset, turn off the Label Printer, and then turn it on again. 4 If the error is not reset, contact Brother Customer Service.

Label Printer Specifications

Model Name	QL-810W	QL-820NWB
Size		
Dimensions	Approximately 4.9 (W) x 9.2 (D) x 5.7 (H) in./ 125.3 (W) x 234 (D) x 145 (H) mm	Approximately 4.9 (W) x 9.2 (D) x 5.7 (H) in./ 125.3 (W) x 234 (D) x 145 (H) mm
Weight	Approximately 2.4 lb (1.12 kg) (without DK Rolls)	Approximately 2.6 lb (1.16 kg) (without DK Rolls)
LED Indicators		
Editor Lite LED, Battery LED, Status LED, Wi-Fi LED		Status LED
Buttons		
Power Button, Feed Button, Cutter Button, WPS Button, Wi-Fi Button, Editor Lite Button		Power Button, Cutter Button, Menu Button, Cancel Button, Up Arrow Button, Down Arrow Button, OK Button
Printing		
Method	Direct thermal printing via thermal head	Direct thermal printing via thermal head
Print head	300 dpi / 720 dots	300 dpi / 720 dots
Print resolution	Standard: 300 dpi x 300 dpi High resolution mode: 300 dpi x 600 dpi	Standard: 300 dpi x 300 dpi High resolution mode: 300 dpi x 600 dpi
Printing speed	AC Adapter: max. 6.9"/sec (176 mm/sec) / For 2-color printing, max. 0.9"/sec (24 mm/sec) Battery: max. 6.9"/sec (176 mm/sec) / For two color printing, max. 0.6"/sec (15 mm/sec) Actual print speed varies depending on the conditions.	AC Adapter: max. 6.9"/sec (176 mm/sec) / For 2-color printing, max. 0.9"/sec (24 mm/sec) Battery: max. 6.9"/sec (176 mm/sec) / For two color printing, max. 0.6"/sec (15 mm/sec) Actual print speed varies depending on the conditions.
Maximum printing width	2.3" (58 mm)	2.3" (58 mm)

Model Name	QL-810W	QL-820NB
Interface		
USB port	Version 2.0 Full Speed (Peripheral)	Version 2.0 Full Speed (Peripheral)
Wi-Fi	<ul style="list-style-type: none"> • Wireless Direct: IEEE 802.11g/n • Infrastructure mode: IEEE 802.11b/g/n • WPS 2.0 	<ul style="list-style-type: none"> • Wireless Direct: IEEE 802.11g/n • Infrastructure mode: IEEE 802.11b/g/n • WPS 2.0
USB host	-	HID class
LAN port	-	10BASE-T/100BASE-TX
Bluetooth	-	Ver 2.1 + EDR Supported profiles: SPP, OPP, BIP, HCRP Supported protocol: iAP
Power Supply		
Adapter	AC Adapter (PA-AD-001A): INPUT AC 100-240 V 50/60 Hz OUTPUT DC 25 V-3.6 A	AC Adapter (PA-AD-001A): INPUT AC 100-240 V 50/60 Hz OUTPUT DC 25 V-3.6 A
Battery (Optional)	Battery Unit (Optional) Li-ion Battery Unit (PA-BU-001): 14.4 V	Battery Unit (Optional) Li-ion Battery Unit (PA-BU-001): 14.4 V
Auto Power-off	Li-ion Battery Unit (PA-BU-001): Off/10/20/30/40/50/60 Minutes AC Adapter (PA-AD-001A): Off/10/20/30/40/50/60 Minutes (To change the Auto Power-off setting, see <i>Changing the Label Printer Settings</i> on page 37.)	Li-ion Battery Unit (PA-BU-001): Off/10/20/30/40/50/60 Minutes AC Adapter (PA-AD-001A): Off/10/20/30/40/50/60 Minutes (To change the Auto Power-off setting, see <i>Changing the Label Printer Settings</i> on page 37.)
Other		
Cutter	Durable automatic cutter	
Environment	Operating temperature /humidity When running: between 50°F (10°C) and 95°F (35°C) / between 20% and 80% The maximum wet bulb temperature: 80.6°F (27°C)	Operating temperature /humidity When running: between 50°F (10°C) and 95°F (35°C) / between 20% and 80% The maximum wet bulb temperature: 80.6°F (27°C)
Compatible operating systems		

Because some P-touch Editor functions are not available with the Label Printer, keep the following points in mind when using P-touch Editor to create templates.

You can check a preview of the printed template before the created template is transferred to the Label Printer. For more information, see *Transferring the Template to P-touch Transfer Manager* on page 123.

Notes on Creating Templates

- Some of the text in the template that is transferred to the Label Printer will be printed using similar fonts and character sizes that are loaded in the Label Printer. As a result, the printed label may differ from the image of the template created in P-touch Editor.
- Depending on the text object setting, the character size may be automatically reduced or some of the text may not be printed. If this occurs, change the text object setting.
- Although character styles can be applied to individual characters with P-touch Editor, styles can be applied to a block of text only with the Label Printer. In addition, some character styles are not available on the Label Printer.
- Backgrounds specified with P-touch Editor are not compatible with the Label Printer.
- A P-touch Editor layout that uses the split printing function (enlarging the label and printing it on two or more labels) cannot be transferred.
- Only the portion of the label within the printable area is printed.
- Fields that overflow the print area may not be printed completely.

Notes on Transferring Templates

- The printed label may differ from the image that appears in the preview area of P-touch Transfer Manager.
- If a barcode not loaded on the Label Printer is transferred to the Label Printer, the barcode will be converted into an image if it is a 2-dimensional barcode. The image of the converted barcode cannot be edited.
- All transferred objects that cannot be edited by the Label Printer are converted into images.
- Grouped objects will be converted into a single bitmap.

Notes on Transferring Data Other Than Templates

- If the number or order of fields in a database is changed and only the database (.csv file) is transferred to update it, the database may not link correctly with the template. In addition, the first line of data in the transferred file must be recognized by the Label Printer as "field names".
- Logos, symbols, and graphics downloaded to the Label Printer will automatically be scaled like the resident font or any of the resident symbol in the library.

Supported Protocols and Security Features

Interface	Wireless	IEEE 802.11b/g/n (Infrastructure Mode) IEEE 802.11g/n (Wireless Direct Mode)
	Ethernet (QL-820NWB only)	Ethernet 10BASE-T/100BASE-TX Auto Negotiation
Network (Common)	Protocol (IPv4)	ARP, RARP, BOOTP, DHCP, APIPA (Auto IP), mDNS, WINS, NetBIOS name resolution, DNS Resolver, LPR/LPD, Custom Raw Port/Port9100, FTP Server, TFTP client and server, SNTP client, ICMP, LLMNR responder, SNMPv1/v2c
	Protocol (IPv6)	NDP, RA, DNS Resolver, LPR/LPD, mDNS, Custom Raw Port/Port9100, FTP Server, TFTP client and server, ICMP, LLMNR responder, SNMPv1/v2c
Network (Security)	Wireless	WEP 64/128 bit, WPA/WPA2-PSK, LEAP, EAP-FAST, PEAP, EAP-TTLS, EAP-TLS

Types of Network Connections and Protocols

You will find basic information about the advanced network features of the Label Printer, along with general networking and common terms.

The supported protocols and network features differ depending on the model you are using.

Types of Network Connections

Peer-to-Peer printing using TCP/IP

In a Peer-to-Peer environment, each computer directly sends and receives data to each device. There is no central server controlling file access or Label Printer sharing.

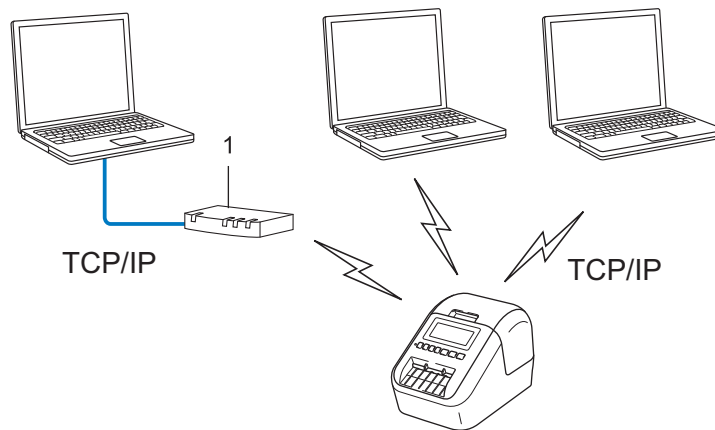

1 Router

- In a smaller network of two or three computers, we recommend the Peer-to-Peer printing method as it is easier to configure than the Network Shared printing method. See *Network Shared printing* on page 189.
- Each computer must use the TCP/IP Protocol.
- Your Label Printer needs an appropriate IP address configuration.
- If using a router, you must configure the Gateway address on the computers and your Label Printer.

Network Shared printing

In a Network Shared environment, each computer sends data via a centrally controlled computer. This type of computer is often called a “Server” or a “Print Server”. Its job is to control the printing of all print jobs.

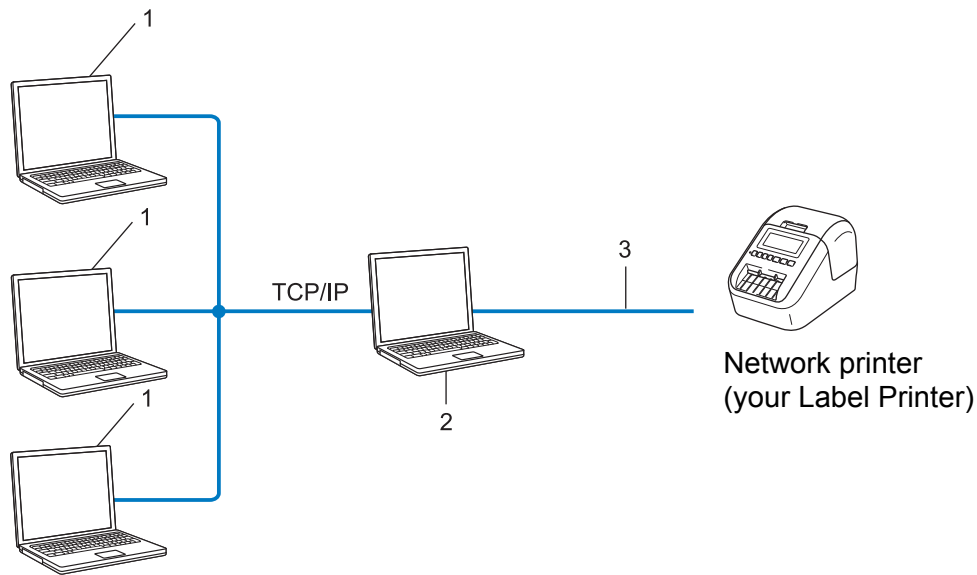

- 1 Client computers**
- 2 Also known as “Server” or “Print server”**
- 3 TCP/IP or USB**

- In a larger network, we recommend using a Network Shared printing environment.
- The “server” or the “print server” must use the TCP/IP print protocol.
- Your Label Printer needs to have an appropriate IP address configuration, except when the Label Printer is connected via the USB interface to the server.

Configuring Your Label Printer for a Network

IP Addresses, Subnet Masks and Gateways

To use the Label Printer in a networked TCP/IP environment, you must configure its IP address and subnet mask. The IP address you assign to the print server must be on the same logical network as your host computers. If it is not, you must correctly configure the subnet mask and the gateway address.

IP address

An IP address is a series of numbers that identifies each device connected to a network. An IP address consists of four numbers separated by dots. Each number is between 0 and 254.

■ For example in a small network, you would normally change the final number:

- 192.168.1.1
- 192.168.1.2
- 192.168.1.3

How the IP address is assigned to your print server:

If you have a DHCP/BOOTP/RARP server on your network, the print server will automatically obtain its IP address from that server.



Note

On smaller networks, the DHCP server may also be the router.

If you do not have a DHCP/BOOTP/RARP server, the Automatic Private IP Addressing (APIPA) protocol will automatically assign an IP address from the range 169.254.0.1 to 169.254.254.254. The subnet mask is automatically set to 255.255.0.0 and the gateway address is set to 0.0.0.0.

By default, the APIPA protocol is enabled. To disable the APIPA protocol, use BRAdmin Light or Web Based Management (web browser).

Subnet mask

Subnet masks restrict network communication.

■ For example, Computer 1 can communicate with Computer 2

- Computer 1

IP Address: 192.168.1.2

Subnet Mask: 255.255.255.0

- Computer 2

IP Address: 192.168.1.3

Subnet Mask: 255.255.255.0

The 0 in the Subnet mask signifies that there is no limit to communication at this part of the address. In the example above, this means that you can communicate with any device with an IP address that begins with 192.168.1.x. (where x is a number between 0 and 254).

Gateway (and router)

A gateway is a network point that acts as an entrance to another network and sends data transmitted via the network to an exact destination. The router knows where to direct data that arrives at the gateway. If a destination is located on an external network, the router transmits data to the external network. If your network communicates with other networks, you may need to configure the Gateway IP address. If you do not know the Gateway IP address, contact your network administrator.

Wireless Network Terms and Concepts

Security Terms

Authentication and encryption

Most wireless networks use some kind of security settings. These security settings define the authentication (how the device identifies itself to the network) and encryption (how the data is encrypted as it is sent on the network). **If you do not correctly specify these options when you are configuring your Brother wireless printer, it will not be able to connect to the wireless network.** Make sure you configure these options carefully.

Authentication and Encryption methods for a personal wireless network

A personal wireless network is a small network, for example using your Label Printer in a wireless network at home, without IEEE 802.1x support.

To use your Label Printer in an IEEE 802.1x supported wireless network, see *Authentication and Encryption methods for an enterprise wireless network* on page 193.

Authentication methods

■ Open system

Wireless devices are allowed to access the network without any authentication.

■ Shared key

A secret pre-determined key is shared by all devices that will access the wireless network.

The Brother wireless printer uses a WEP key as the pre-determined key.

■ WPA-PSK

Enables a Wi-Fi Protected Access Pre-shared key (WPA-PSK), which enables the Brother wireless printer to associate with access points using TKIP for WPA-PSK.

■ WPA2-PSK

Enables a Wi-Fi Protected Access Pre-shared key (WPA2-PSK), which enables the Brother wireless printer to associate with access points using AES for WPA2-PSK (WPA-Personal).

■ WPA/WPA2-PSK

Enables a Wireless Protected Access Pre-shared key (WPA-PSK/WPA2-PSK), which enables the Brother wireless printer to associate with access points using TKIP for WPA-PSK or AES for WPA-PSK and WPA2-PSK (WPA-Personal).

Encryption methods

■ None

No encryption method is used.

■ WEP

When using WEP (Wired Equivalent Privacy), the data is transmitted and received with a secure key.

■ TKIP

TKIP (Temporal Key Integrity Protocol) provides per-packet key mixing, a message integrity check and rekeying mechanism.

■ AES

Advanced Encryption Standard (AES) provides stronger data protection using a symmetric-key encryption.

When [Communication Mode] is set to [Ad-hoc]

Authentication Method	Encryption Mode
Open System	None
	WEP

When [Communication Mode] is set to [Infrastructure]

Authentication Method	Encryption Mode
Open System	None
	WEP
Public Key Authentication	WEP
WPA/WPA2-PSK	TKIP+AES

Network key

■ Open system/Shared key with WEP

This key is a 64-bit or 128-bit value that must be entered in an ASCII or hexadecimal format.

- 64 (40) bit ASCII:
Uses five text characters. For example, “WSLAN” (case-sensitive)
- 64 (40) bit hexadecimal:
Uses 10 digits of hexadecimal data. For example, “71f2234aba”
- 128 (104) bit ASCII:
Uses 13 text characters. For example, “Wirelesscomms” (case-sensitive)
- 128 (104) bit hexadecimal:
Uses 26 digits of hexadecimal data. For example, “71f2234ab56cd709e5412aa2ba”

■ WPA/WPA2-PSK and TKIP with AES

Uses a Pre-Shared Key (PSK) that is eight or more characters in length, up to a maximum of 63 characters.

Authentication and Encryption methods for an enterprise wireless network

An enterprise wireless network is a large network with IEEE 802.1x support. If you configure your printer in an IEEE 802.1x supported wireless network, you can use the following authentication and encryption methods:

Authentication methods

■ LEAP (For wireless network)

Cisco LEAP (Light Extensible Authentication Protocol) has been developed by Cisco Systems, Inc. and uses a user ID and password for authentication.

■ EAP-FAST

EAP-FAST (Extensible Authentication Protocol-Flexible Authentication via Secured Tunnel) has been developed by Cisco Systems, Inc. and uses a user ID and password for authentication, and symmetric key algorithms to achieve a tunnelled authentication process.

The printer supports the following inner authentication methods:

- EAP-FAST/NONE
- EAP-FAST/MS-CHAPv2
- EAP-FAST/GTC

■ PEAP

PEAP (Protected Extensible Authentication Protocol) has been developed by Microsoft Corporation, Cisco Systems and RSA Security. PEAP creates an encrypted SSL (Secure Sockets Layer)/TLS (Transport Layer Security) tunnel between a client and an authentication server, for sending a user ID and password. PEAP provides mutual authentication between the server and the client.

The printer supports the following inner authentication methods:

- PEAP/MS-CHAPv2
- PEAP/GTC

■ EAP-TTLS

EAP-TTLS (Extensible Authentication Protocol Tunnelled Transport Layer Security) has been developed by Funk Software and Certicom. EAP-TTLS creates a similar encrypt SSL tunnel to PEAP, between a client and an authentication server, for sending a user ID and password. EAP-TTLS provides mutual authentication between the server and the client.

The printer supports the following inner authentication methods:

- EAP-TTLS/CHAP
- EAP-TTLS/MS-CHAP
- EAP-TTLS/MS-CHAPv2
- EAP-TTLS/PAP

■ EAP-TLS

EAP-TLS (Extensible Authentication Protocol Transport Layer Security) requires digital certificate authentication both at a client and an authentication server.

Encryption methods

■ TKIP

TKIP (Temporal Key Integrity Protocol) provides a per-packet key mixing a message integrity check and rekeying mechanism.

■ AES

Advanced Encryption Standard (AES) provides stronger data protection using a symmetric-key encryption.

■ CKIP

The original Key Integrity Protocol for LEAP by Cisco Systems, Inc.

When [Communication Mode] is set to [Infrastructure]

Authentication Method	Encryption Mode
LEAP	CKIP
EAP-FAST/NONE	TKIP+AES
EAP-FAST/MS-CHAPv2	TKIP+AES
EAP-FAST/GTC	TKIP+AES
PEAP/MS-CHAPv2	TKIP+AES
PEAP/GTC	TKIP+AES
EAP-TTLS/CHAP	TKIP+AES
EAP-TTLS/MS-CHAP	TKIP+AES
EAP-TTLS/MS-CHAPv2	TKIP+AES
EAP-TTLS/PAP	TKIP+AES
EAP-TLS	TKIP+AES

User ID and password

The following security methods support a user ID less than 64 characters and a password less than 32 characters in length:

- LEAP
- EAP-FAST
- PEAP
- EAP-TTLS
- EAP-TLS (For user ID)

General Procedure for the P-touch Template Function

The general procedure for using the P-touch Template function is described below.

For more information on specifying the various settings, see *Printing Labels Using P-touch Template* on page 69.

Before connecting the Barcode Scanner to this Label Printer, make sure that the Barcode Scanner settings match the settings in the P-touch Template Settings tool that is specified during preparation. For more information, see *Preparation* on page 70.

- 1 Use P-touch Editor to create a template and then transfer it to the Label Printer.
- 2 Connect the Barcode Scanner to the Label Printer.
- 3 Scan the “P-touch template command” barcode to specify new settings or clear the previous settings.
- 4 Scan the “Basic settings” barcode to specify the number of copies.
- 5 Specify the appropriate settings (A, B, or C).

A. Standard Template Printing

- i. Scan the “Preset template number” barcode.

B. Advanced Template Printing

- i. Scan the “Select template” barcode, and then scan the barcodes under “For entering numbers”.
- ii. Scan the barcode whose data you want to use or copy.
- iii. Scan the “Begin printing” barcode.

C. Database Lookup Printing

- i. Scan the “Select template” barcode, and then scan the barcodes under “For entering numbers”.
- ii. Scan the key barcode for the database data.
- iii. Scan the “Delimiter” barcode.
- iv. Scan the “Begin printing” barcode.

- 6 The specified label is printed.

List of Barcodes for Specifying Settings

For more information about using these barcodes for specifying the Label Printer settings, see *Printing Labels Using P-touch Template* on page 69.



Note

- When using the barcodes in this list, set “Trigger for P-touch Template Printing” and “Command Prefix Character” to the factory settings in the P-touch Template Settings tool.
- Make sure you print the barcodes at a high resolution so that the barcode scanner can read them correctly to print the labels you want.

- P-touch template command (initialize + begin specifying settings)



Escia3^II

- Basic settings

Auto cut on (Cut every one label) + Cut at end on



^c01011

Auto cut on (Cut every two labels) + Cut at end on



^c01021

Auto cut off + Cut at end on



^c00001

Auto cut off + Cut at end off



^c00000

Give priority to print speed



^qS0

Give priority to print quality



^qS1

Number of copies



^cN

■ For entering numbers ¹



■ Preset template number

Preset template 1



Preset template 2



Preset template 3



Preset template 4



Preset template 5



Preset template 7



Preset template 9



Preset template 6



Preset template 8



Preset template 10



■ Select template



■ Number of serialized copies



■ Delimiter



■ Initialize template data



■ Begin printing



¹ These are used when specifying the number of copies printed and when selecting a template number. Scan barcodes to specify a three-digit number, such as [0][0][7] or [0][1][5]. The setting is automatically applied when three digits have been specified. To change settings, scan the “Number of copies” barcode again when changing the number of copies or scan the “Select template” barcode again when changing the template number, and then scan the barcodes for the new three-digit number.

Using the Optional Battery Unit (Rechargeable Li-ion Battery included)

Charging the Optional Battery Unit (PA-BU-001)



Note

- Before use, you must charge the Battery Unit.
- To fully charge the Battery Unit, charge for approximately 2.5 hours.

- 1 Make sure the Battery Unit is installed in the Label Printer.
- 2 Use the AC Adapter and AC Power Cord to connect the Label Printer to an AC power outlet. For QL-810W, the Battery () LED lights in orange during charging, and it turns off when the Battery Unit is fully charged. For QL-820NWB, the Battery Power is shown on the LCD.

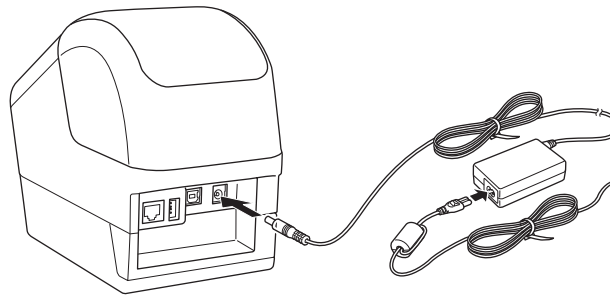

Note

If the Battery Unit is not fully charged and you use the Label Printer to print, feed, or perform another operation, the Battery Unit temporarily stops charging, and continues automatically after the operation is completed.

Discontinue charging the Battery Unit

To stop charging the Battery Unit, disconnect the AC Adapter.

Notes on Using the Battery Unit

- Before use, fully charge the Battery Unit. Do not use it until it is fully charged.
- Charge the Battery Unit in environments between 50°F and 95°F (10°C and 35°C), otherwise the Battery Unit will not charge. If the charging stops because the environment temperature is too low or too high, place the Label Printer in environment between 50°F and 95°F (10°C and 35°C) and try charging again.
- If the Label Printer is used to print, feed, or perform another operation when both the battery is installed and the AC Adapter is connected, the charging may stop even if the battery is not fully charged. When the operation to the printer stops, the battery continue to charge.
- For QL-820NWB, the condition of Battery Unit can be checked from the LCD.

Battery Unit Characteristics

To ensure the best performance and longest life from the Battery Unit:

- Do not use or store the Battery Unit in a location exposed to extreme high or low temperatures as it may discharge more quickly. This may happen when using a Battery Unit with a high charge (90% charged or more) in a location exposed to high temperatures.
- Remove the Battery Unit when storing the Label Printer for a long period of time.
- Store a Battery Unit with a less than 50% charge in a cool dry place out of direct sunlight.
- Recharge the Battery Unit every six months if it is stored for a long period of time.
- If you touch a part of the Label Printer while the Battery Unit is charging, that part of the Label Printer may feel warm. This is normal, and the Label Printer may be used safely; however, if the Label Printer becomes extremely hot, discontinue use and allow to cool.

Using the Optional Battery Unit (Rechargeable Li-ion Battery included)

Product Specifications

Rechargeable Li-ion Battery Unit

Size: approx. 4.92" (W) x 7.76" (D) x 2.72" (H) (125 mm (W) x 197 mm (D) x 69 mm (H))

Weight: approx. 1.31 lb (0.59 kg)

Voltage: 14.4 V

Capacity: 1750 mAh

Charging/discharging cycle: approx. 300 times

Charging time: approx. 2.5 hours

Using the Brother Barcode Scanner (Optional: PA-BR-001) (QL-820NWB only)

P-touch template mode provides operations for inserting data into text and barcode objects in a downloaded template from a Barcode Scanner to the connected Label Printer.

Because the Brother Barcode Scanner (optional: PA-BR-001) has been set according to the [P-touch Template Settings] in the Printer Setting Tool, you can quickly use this Barcode Scanner without changing its settings.

For information about using the Brother Barcode Scanner, see the instruction manual included with the Barcode Scanner.

brother