

# PXR Series

Advanced Self-Tuning Temperature and Process Controllers

FUJI PXR SERIES CONTROLLERS

## Key Features

- PID with fuzzy control of self-tuning
- 16 Ramp/soak segments
- Large LED display
- Digital input
- Auto-tune
- Timer function
- Heater burnout alarm
- Replaces most other controllers in market
- Excellent for after-market support

The new PXR series controllers are the newest additions to Fuji Electric's trusted line of temperature and process controllers. They are now packed with more features and options than before, and the new low price is unbeatable.

They come in several sizes – 1/32 DIN, 1/16 DIN, 1/8 DIN and 1/4 DIN. These controllers have all the standard features that you expect from Fuji Electric's superior controllers, and more. In addition to auto-tuning and fuzzy control, it now comes with self-tuning — an innovation in the control field. It automatically retunes the controller under certain conditions, without the need to revert to auto-tuning. The standard 8-segment ramp/soak feature has been expanded to include two patterns that can be linked to create a 16-step profile. The PXR accepts temperature and process inputs and offers a choice of three kinds of outputs to meet a wide variety of needs in the process industries. Low-cost options include dual outputs, programmable alarms, remote setpoint, RS485 communications, analog retransmission, digital input, timer function, heater burnout alarm and 24V AC/DC supply voltage.

One of the most impressive features is the large LED display. The faceplate, designed for NEMA 4X (IP66 equivalent) is watertight and corrosion-resistant. The easy-to-use 3-button keypad allows for programming similar to the popular PXW controller. The screw-terminal on the back further reduces the cost by eliminating the need for sockets. The PXR3 can be DIN-rail mounted with the optional adapter.

Remote monitoring of up to 31 controllers at a time is possible with the RS485 option that uses the industry-standard Modbus™ protocol. The communications option comes with our free Windows®-based software, PXR-LITE™. The software allows you to program the controller from the PC and view real-time data and trend graph while logging the data into a text file.

A powerful tool for the OEM customer is the Program Loader option with Windows®-based software. Programs for different applications can be saved to and from the controller.

## Features

- **Advanced control functions** PID Plus Self Tuning; PID Plus Fuzzy Control; Auto-tuning
- **NEMA 4X faceplate with large LED display** 4-digit, red and green display; Waterproof faceplate conforms to NEMA-4X/IP66
- **Multiple inputs** Choose between thermocouple/RTD and 4-20mA/0-5V inputs
- **Single or dual control outputs** Relay, SSR driver or 4-20mA
- **Ramp/soak function** Up to 16 ramp/soak segments or two 8-segment patterns, a standard feature
- **Programmable alarms option** 2 programmable SPST relays with On/Off delay function
- **Remote setpoint option** Change setpoint with a 1-5V signal
- **Analog retransmission option** 4-20mA retransmission of PV, SV, MV, DV
- **Digital input option** Change between 2 setpoints; Change between ramp/soak and standby; Start/reset the ramp/soak; Start/stop the auto tuning; Cancel the alarm latch; Start the incorporated timer
- **Timer function** On-delay or off-delay timer activated with digital input; Up to 2 timer outputs can be obtained
- **Heater burnout alarm option** If heater burns out, alarm goes off
- **Communications option** RS485 (Modbus™ protocol) interface permits remote monitoring of up to 31 units from a PC. Comes with free Windows®-based software, PXR-LITE™
- **Warranty** Manufactured in a ISO 9001 facility and backed by a 3-year warranty



Information subject to change without notice. Prices in USD.

10

Find Quality Products Online at:

[www.GlobalTestSupply.com](http://www.GlobalTestSupply.com)

[sales@GlobalTestSupply.com](mailto:sales@GlobalTestSupply.com)

## Specifications

### General Specifications

**Power supply voltage** 100 (-15%) to 240V (+10%) AC, 50/60Hz; 24V (±10%) AC/DC

**Power consumption** PXR3: 6VA (100 V AC), 8VA (220V, 24V). PXR4: 8VA (100V), 10VA (220V), 12VA (24V). PXR5, 9: 10VA (100V), 12VA (220V, 24V)

**Reference junction compensation accuracy** ±1°C at 23°C

### Input

**Input signal** Thermocouple: J, K, R, B, S, T, E, N, PL2. RTD: Pt100. Voltage, current. For 1 to 5V/4 to 20 mA DC, 0 to 5V/0 to 20 mA DC, use 250 ohm shunt resistor included

**Input filter** 0 to 900.0 sec set in 0.5 sec steps

**Burnout** For thermocouple or RTD input, control output direction (upper or lower) is selectable

### Control Function

**Control action** On/Off; PID control (with auto-tuning, self-tuning); Fuzzy Control (with auto-tuning)

**Proportional band (P)** 0 to 999.9% of measuring range set in 0.1% steps

**Integral time (I)** 0 to 3200 sec set in 1 sec steps

**Differential time (D)** 0 to 999.9 sec set in 1 sec steps

**Proportional cycle** 1 to 150 sec set in 1 sec steps

**Hysteresis width** 0 to 50% of measuring range; For on/off action only

**Input sampling cycle** 0.5 sec

### Control Output 1 (select one)

**Relay contact** PXR4, 5, 9: SPDT, 220 V AC/30 V DC, 3A (resistive load). PXR3: SPST contact, 220 V AC/30 V DC, 3A (resistive load)

**SSR** PXR4, 5, 9: ON—17 to 25 V DC; OFF—0.5 V DC or less. PXR3: 12 to 16 V DC. Max. current: 20mA or less

**4 to 20 mA DC** PXR4, 5, 9: Allowable load resistance 600 ohms or less. PXR3: 100 to 500 ohms

### Control Output 2 (Heating/Cooling Control) (select one)

**Relay contact** SPST, 220 V AC/30 V DC, 3A (resistive load)

**SSR** PXR4, 5, 9: ON—17 to 25 V DC; OFF—0.5 V DC or less. PXR3: 12 to 16 V DC. Max. current: 20mA or less

**4 to 20 mA DC** PXR4, 5, 9: Allowable load resistance 600 ohms or less. PXR3: 100 to 500 ohms

## Program Loader Interface

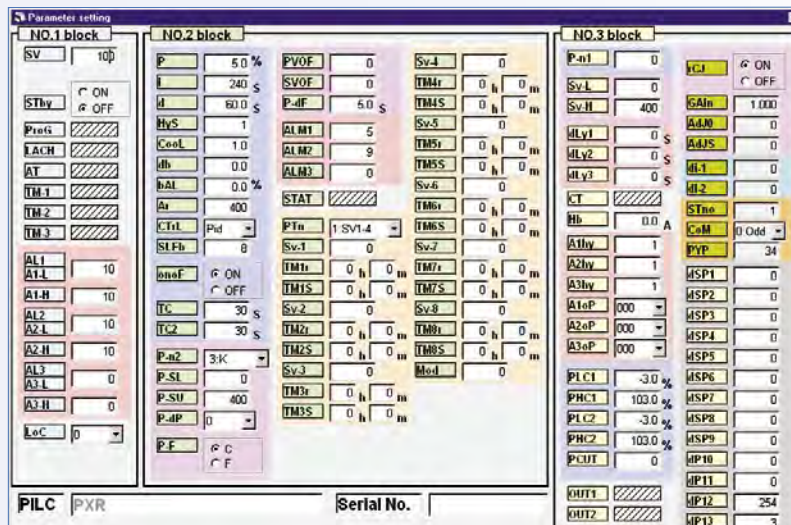

The Program Loader for Fuji Electric's PX and PXR series controllers is a powerful tool for the OEM customer. Using the PXR4 Loader Assembly, the controller can be configured from a PC running on Windows environment.

### Features

- Retrieve or store controller data
- Selectively mask or unmask parameters for viewing on the controller
- Clone settings to other controllers from saved files
- Print data report

## PXR LITE Communications Software

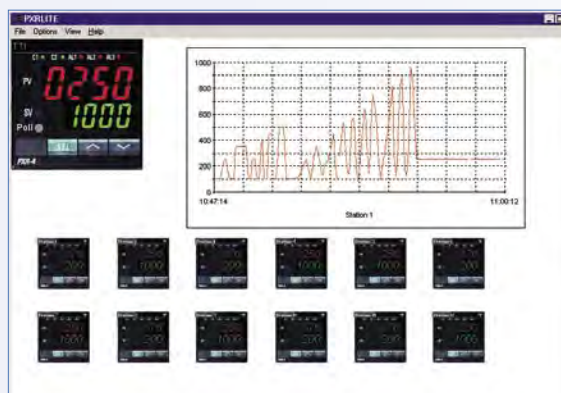

PXR-LITE™ is free Windows®-based software that is supplied with the communications option on a PXR controller. It is the latest in control and monitoring of Fuji Electric's PXR series controllers. It provides continuous remote monitoring of single or multiple controllers using a single half-duplex RS485 line.

### Features

- Monitor and control up to 31 controllers from a PC via RS485-RS232 signal converter

- Real-time charting and data-logging
- Remote setpoint adjustment
- Set control modes, alarms and other control parameters
- Remote auto-tuning and ramp-soak programming
- Live display of process and setpoint values, alarm annunciators
- View single-station or multi-station data
- Comprehensive help file included
- Runs on Windows environment, version 3.1 or later

## Operation and Display Section

**Parameter setting method** Digital setting by 3 keys; Key lock function provided

**Display unit** Process value/set value displayed individually 4 digits, 7-segment LED

**Status display LED** Control output, process alarm output, heater burnout alarm output

**Indication accuracy (at 23°C)** Thermocouple:  $\pm$  (0.5% of measuring range)  $\pm$  1 digit  $\pm$ 1°C. For thermocouple R at 0 to 500°C:  $\pm$  (1% of measuring range)  $\pm$ 1 digit  $\pm$ 1°C. For thermocouple B at 0 to 400°C:  $\pm$  (5% of measuring range)  $\pm$ 1 digit  $\pm$ 1°C. RTD, voltage/current:  $\pm$ (0.5% of measuring range)  $\pm$ 1 digit

### Alarm (option)

**Alarm type** Absolute alarm, deviation alarm, zone alarm with upper and lower limits for each; hold function available; alarm latch function provided

**Alarm ON-delay** Delay setting 0 to 9999 sec set in 1 sec steps

**Process alarm output** Relay contact: SPST, 220 V AC/30 V DC, 1A (resistive load); Max. 2 points (PXR3), max. 3 points (PXR4, 5, 9)

**Heater burnout option** (not available on PXR3) Alarm setting range: 1 to 50A Available only when control output is relay or SSR drive.

**Heater burnout alarm output** Relay contact: SPST, 220 V AC/30 V DC, 1A (resistive load); 1 output point

**Current detector** CTL-6-S for 1 to 30 A; CTL-12 for 20 to 50 A

### Digital Input (option)

**Points** 1 or 2; contact closure. 5 V DC, approx. 2mA

**Function (select one)** Set value (SV, SV1 to 3) changeover, start/stop control action, start/reset ramp/soak action, start/stop auto-tuning, cancel alarm latch, start incorporated timer

### Retransmission Output (option)

**Output signal** 4-20 mA DC

**Load resistance** 500 ohms or less

**Output accuracy**  $\pm$ 0.3% FS

**Output selection** PV, SV, MV, DV (SV-PV)



PXR4 Terminal Cover (option)



PXR3 DIN Rail Adapter

### Timer Function (option)

**Start** By digital input option

**Setting** 0 to 9999 sec set in 1 sec steps

**Action** Event ON-delay or OFF-delay

**Signal output** Alarm output relays used; 2 points are available

### Communication Function (option)

**Physical specifications** EIA RS485

**Communication protocol** Modbus (RTU).

Free Windows®-based software, PXR-LITE™

**Communication method** 2-wire method; half-duplex, bit serial, start-stop sync type

**Data type** 8 bits. Parity: odd/even/none

**Communication rate** 9600 bps

**Connection aspect** Multi-drop up to 31 controllers

**Communication distance** Total extension 500m or less

**RS232C/RS485 signal converter** RSFC24 (recommended, see ordering information)

### Remote Setpoint Option

**Input signal** 1 to 5 V DC, 1 point

**Accuracy**  $\pm$ 0.5%  $\pm$ 1 digit

**Input sampling cycle** 0.5 sec

**Display of remote mode** LED on front panel

**Input impedance** 1M ohms or more

### Other Functions

**Parameter mask function** Parameter display can be disabled from keypad

**Ramp/soak function** 8 ramps and 8 soaks; 1 or 2 program patterns; digital input allows start/reset of the action

### Operating and Storage Conditions

**Ambient operating temperature** 14 to 122°F (-10 to 50°C)

**Ambient operating humidity** Less than 90% RH (no condensation)

**Storage temperature** -4 to 140°F (-20 to 60°C)

### Structure

**Mounting method** Panel flush mounting. PXR3 can be DIN-rail mounted using the optional adapter

**External terminal** Screw terminal

**Dimensions** PXR3: 1 x 2 x 4 in. (24 x 48 x 98mm). PXR4: 1.89 x 1.89 x 3.37 in. (48 x 48 x 79.8 mm). PXR5: 2.07 x 3.96 x 3.77 in. (52.5 x 100.5 x 95.8 mm). PXR9: 3.96 x 3.96 x 3.77 in (100.5 x 100.5 x 95.8 mm)

**Protective structure** Front panel NEMA4X (IEC standard IP66 equivalent) (when mounted on panel with supplied gasket). Rear case: IEC IP20

**Outer color** Black (front panel, case)

**Agency approvals** UL, c-UL recognized (UL873), CSA (C22.2 No.24-93), CE certified (LVD:EN61010-1, EMC:1326-1)

### Optional Items

**Current transformer** For 1 to 30 A: CTL-6-S. For 20 to 50 A: CTL-12

**Signal converter for communication function** RSFC24

**DIN Rail adapter** For PXR3 only

**Terminal cover** For PXR4 only



## Ordering Information (PXR3)

P X R A - B C D 1 - E F G A 1

To create a part number fill in the boxes above with the appropriate number and/or letter from the corresponding list below.

### Box A: Front Panel Size

3 = 1/32 DIN (24x48mm)

### Box B: Input Signal

T = Thermocouple (°C)

R = Thermocouple (°F)

N = RTD, Pt100 ohm, 3-wire type (°C)

S = RTD, Pt100 ohm, 3-wire type (°F)

B = 4-20mA DC, 1-5V DC

A = 0-20mA DC, 0-5V DC

### Box C: Control Output 1

A = Relay contact output

C = SSR or SSC drive output

E = 4-20mA DC output

### Box D: Control Output 2

Y = None

A = Relay contact output

C = SSR or SSC drive output

E = 4-20mA DC output

### Box E: Alarm Options

4 = None

5 = High/low alarm 1 point

G = High/low alarm 2 points<sup>1</sup>

### Box F: Power Supply

V = Standard (100-240 VAC, 50/60Hz)

B = 24V AC/DC (50/60Hz)

### Box G: Additional Functions

0 = None

M = RS485 communication (Modbus)

Q = Retransmission + DI 1 point

R = Retransmission (4-20mA DC)

T = Digital Input (DI) x 2

V = RS485 communications (Modbus)  
+ DI

Note: RS485 option comes with Free software, PXR-LITE. RS485 requires signal converter to connect to PC, P/N RSFC24 recommended.

<sup>1</sup>High/low alarm 2 points not available when control output 2 is selected.

## Ordering Information (PXR4, PXR5, PXR7, PXR9)

P X R A - B C D 1 - E F G A 1

To create a part number fill in the boxes above with the appropriate number and/or letter from the corresponding list below.

### Box A: Front Panel Size

4 = 1/16 DIN (48x48mm)

5 = 1/8 DIN (48x96mm)

7 = 72 x 72mm

9 = 1/4 DIN (96x96mm)

### Box B: Input Signal

T = Thermocouple (°C)

R = Thermocouple (°F)

N = RTD, Pt100 ohm, 3-wire type (°C)

S = RTD, Pt100 ohm, 3-wire type (°F)

B = 4-20mA DC, 1-5V DC

A = 0-20mA DC, 0-5V DC

### Box C: Control Output 1

A = Relay contact output

C = SSR or SSC drive output

E = 4-20mA DC output<sup>1</sup>

G = Triac 1A, 250 VAC<sup>4</sup>

### Box D: Control Output 2

Y = None

A = Relay contact output

C = SSR or SSC drive output

E = 4-20mA DC output<sup>1</sup>

G = Triac 1A, 250 VAC<sup>4</sup>

R = Retransmission (4-20mA DC)

### Box E: Alarm Options

4 = None

6 = Heater break alarm<sup>1,2</sup>

G = High/low alarm 2 points

H = High/low alarm 2 points +

heater break alarm<sup>1,2</sup>

M = Alarm 3 points

D = Remote setpoint<sup>3</sup>

P = Remote setpoint + alarm 2 points<sup>3 11</sup>

### Box F: Power Supply

V = Standard (100-240V AC, 50/60Hz)

B = 24V AC/DC (50/60Hz)

### Box G: Additional Functions

0 = None

M = RS485 communication (Modbus)

S = Digital Input (DI) x 1

T = Digital Input (DI) x 2<sup>1</sup>

V = RS485 communications (Modbus)  
+ DI<sup>1,3</sup>

Note: RS485 option comes with Free software, PXR-LITE. RS485 requires signal converter to connect to PC, P/N RSFC24 recommended.

<sup>1</sup>Heater break option not available with 4-20mA output, or with 2 digital inputs, or with RS485 +1 digital input.

<sup>2</sup>Must order current transformer CTL-6-S or CTL-12 with heater break option.

<sup>3</sup>Remote setpoint option not available with RS485 +1 digital input.

<sup>4</sup>UL and c-UL not available with PXR5 or PXR9.

## Accessories

CTL-6-S Current transformer for 1-30A

CTL-12 Current transformer for 20-50A

RSFC24 RS485 to RS232 signal converter

PXR4 Loader Assembly Program loader for PXR4 (can be used for PX series also)

PXR3 Rail Adapter Mounting adapter for DIN rail installation

PXR4 Terminal Cover Terminal block protective cover

Information subject to change without notice. Prices in USD.

010110

# PXR4 Temperature Controller Socket Series

---

## Ordering Information (PXR4 Socket Version)

---

P X R 4 - A B S 1 - C D 0 A 1

To create a part number fill in the boxes above with the appropriate number and/or letter from the corresponding list below.

### Front Panel Size

4 = 1/16 DIN (48x48mm)

### Box A: Input Signal

T = Thermocouple (°C)

R = Thermocouple (°F)

N = RTD, Pt100 ohm, 3-wire type (°C)

S = RTD, Pt100 ohm, 3-wire type (°F)

B = 4-20mA DC, 1-5V DC

A = 0-20mA DC, 0-5V DC

### Box C: Alarm Options

4 = None

5 = High/low alarm 1 point

G = High/low alarm 2 points

### Box D: Power Supply

V = Standard (100-240V AC, 50/60Hz)

B = 24V AC/DC (50/60Hz)

### Box B: Control Output 1

A = Relay contact output

C = SSR or SSC drive output

E = 4-20mA DC output<sup>1</sup>

G = Triac 1A, 250 VAC<sup>4</sup>

### Accessories

PXR4 Loader Assembly      Program loader for PXR4

PXR4 Terminal Cover      Terminal block protective cover

---

# PXR Series (continued)

## Application Examples

### Furnace Heat Pattern Control

#### Heat Pattern Control — Ramp/Soak Function

##### Digital input

##### Ramp/Soak command

ON : RUN  
OFF : RESET

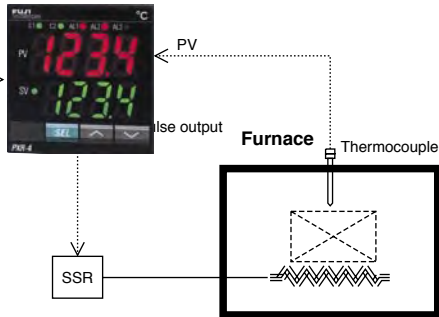

#### Ramp/Soak Function

- Control temperature according to "Heat pattern with ramp"
- Keep temperature stable for a certain period with "Heat pattern" and then cool down
- "Heat pattern" can be Started (RUN) /Reset by an external digital input.

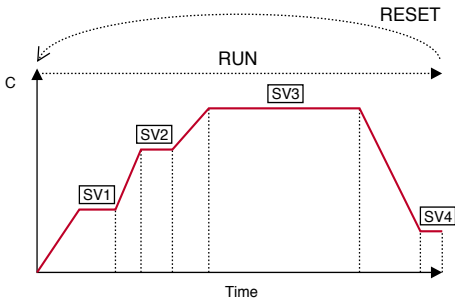

### Plastic Molding Machine

#### Stable temperature control required — Fuzzy + PID Control

##### Digital input

##### Autotuning command

ON : Autotuning Start  
OFF : Autotuning Strat

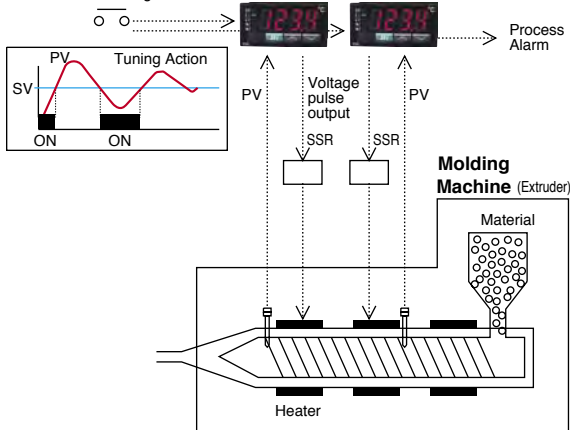

Auto-Tuning can be started/stopped through external digital input

Information subject to change without notice. Prices in USD

### Oven

#### To change SV easily

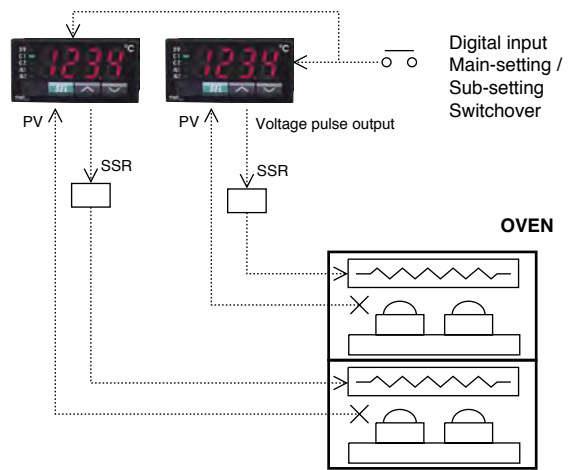

Set Value (SV) can be selected/changed externally.  
<main SV, SV1~3 change over>

### Fryer

#### To keep oil temperature stable

##### Digital input

##### Control : RUN / STAND-BY

OFF : RUN  
ON : STAND-BY

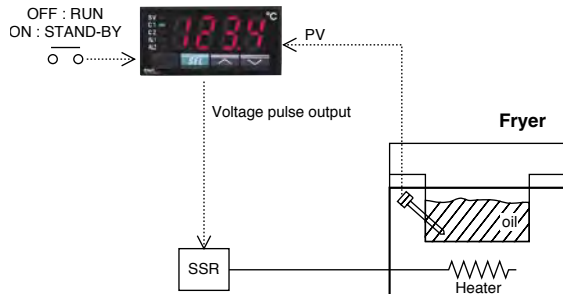

Control RUN/Stand-by selectable through external digital input

### Cooling & Heating Control

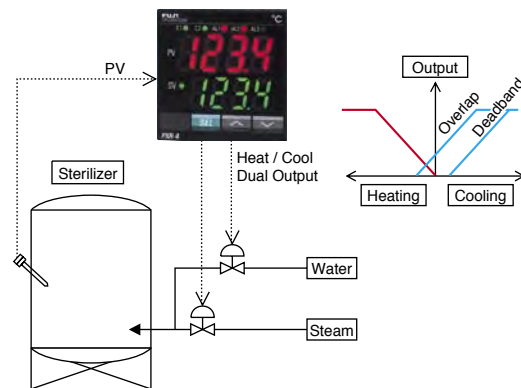

Cooling output and Heating output can be overlapped or a "Dead-band" set between them.