

Watlow® Thermal Solutions For Medical And Clinical Applications



heaters | sensors | controllers



Find Quality Products Online at:

www.GlobalTestSupply.com

sales@GlobalTestSupply.com



INNOVATIVE THERMAL SOLUTIONS FOR MEDICAL AND CLINICAL APPLICATIONS

Temperature continues to play an important role in the development of new medical equipment, biotechnology and clinical diagnostic instrumentation.

With 50 years' experience in the Life Science industries, Watlow® is a leader in breaking new ground in designing, manufacturing and supporting innovative thermal solutions to meet medical advancements and new industry requirements. Leading medical equipment manufacturers rely on Watlow solutions for their patient care equipment, surgical devices and biotechnology and clinical diagnostic instrument application needs.

WATLOW THERMAL SOLUTIONS DELIVER BENEFITS THAT MAKE THE DIFFERENCE:

- Greater temperature responsiveness
- Accurate temperature control of critical processes
- Low leakage current compliance
- Reduced cost, space and device weight
- Superior temperature measurement
- Lower heater mass and temperature uniformity
- Faster processing times
- Reduction in moving parts
- Product miniaturization
- Set up simplification



GLOBAL THERMAL LEADERSHIP

With a reputation for delivering expert application knowledge, global manufacturing capabilities, exceptional technical support and service, Watlow is a preferred and trusted partner with leading medical equipment manufacturers. As a global company, we support international design guidelines, compliance and agency approvals including RoHS, W.E.E.E, CE and UL®. From routine customer issues to engineering and technical problem solving, Watlow's

dedicated global resources will deliver an on-time, cost-effective solution to meet your requirements, wherever and whenever needed. We realize that there is no "one-size-fits-all" solution. You can count on the collective knowledge of Watlow's global team of more than 400 consultative sales agents, field engineers, product specialists and system engineers to offer a choice of solutions that fit the intended use for your particular medical device application.



CHOOSE THE RIGHT PARTNER

Whether it is redesigning existing equipment to extend product life or developing a custom assembly design for new equipment, we will ask the right questions to solve your problem quickly and correctly.

We can complement your team at any project stage from concept to quick prototyping and throughout your product's life

cycle. Watlow has a proven track record in producing high volume, complex heaters and assemblies and a worldwide presence to leverage our vast market knowledge across borders.

Partner with Watlow and take advantage of our broad selection of heaters, sensors and controllers—designed to work together for optimal efficiency and long life.



WE ASK THE RIGHT QUESTIONS TO DELIVER THE BEST SOLUTION

Designing the best heater solution requires technical understanding of thermal requirements and business acumen to best service your application needs. Technical questions we will address during the conversation with a device engineer include:

- What is the application?
- Is the device heating air, gas, fluid or solid material?
- What is the process temperature?
- What is the temperature ramp rate?
- What are the dimensional requirements?
- Are there any known material compatibility issues?
- Are there any voltage limitations?
- Are there any special agency approval requirements?
- What is the heater life expectancy?
- Where is the sensor located?
- How is the system monitored and controlled?
- What is the expected life cycle of the device?

THERMAL SOLUTIONS FOR MEDICAL EQUIPMENT AND PATIENT CARE



Electric heaters and subassemblies enhance the operation of various types of medical, patient care and clinical diagnostic equipment.

Patient safety is critical in equipment and heater design. Safety considerations include electrical (low leakage current), touch safe characteristics and thermal stability.

Medical and diagnostic devices are covered by several regulatory organizations including FDA, UL® and CE. Watlow heaters are engineered and manufactured for compliance with medical equipment, mechanical and electrical isolation requirements and commonly include on-board monitors and safety limit controllers.

Watlow designs heaters and thermal subassemblies to incubate cultures, add warm humidity to respiratory equipment, heat fluids before injection

into the body, stabilize equipment performance, enhance surgical procedures, sterilize instruments and for many other applications.

Injecting warmed fluids into a patient in post-operative recovery can increase body temperature and comfort while accelerating recovery.

Watlow's flexible, cartridge and ULTRAMIC® heaters monitor and control thermal and other processes that are critical to ensuring patient safety and well being by keeping body temperature close to 37°C (98.6°F).

WATLOW THERMAL SOLUTIONS ARE DESIGNED TO SOLVE YOUR MEDICAL AND CLINICAL APPLICATION NEEDS

- Anesthesia delivery systems
- Blood and intravenous (IV) fluid warmers
- Transfusion equipment
- Syringe contrast media heating
- Bloodless surgical procedures
- Hemodialysis and kidney dialysis machines
- Infant warmers and incubators
- Insufflators
- Lithotripters
- Oxygen sensor electrodes
- Respiratory therapy devices (humidifiers, nebulizers and ventilators)
- Thermal ablation instruments
- Hypothermia (warming blankets)
- Wound therapy systems
- Cryotherapeutic chambers
- Apheresis equipment



THERMAL SOLUTIONS FOR BIOTECHNOLOGY EQUIPMENT AND CLINICAL DIAGNOSTIC INSTRUMENTATION

Biototechnology equipment and devices are used to extract, replicate, amplify and sequence DNA from genes. Clinical diagnostic instruments are used in hospitals, clinics, commercial laboratories and test sites to perform tests on human blood and other body fluids.

Watlow has developed high precision heater and controller solutions for biotechnology equipment and clinical diagnostic instrument applications when a uniform operating temperature at or near a body temperature of 37°C (98.6°F) is required for effective application performance. Some applications, including cell incubation and sterilization, may require higher temperatures. Precise temperature is a critical factor for most biotechnology and clinical applications where incubation and transfer of fluids is required as part of a process.

The need for greater throughput at less cost has been met with smaller devices that can turn tests quickly at a reduced cost. Meeting this need drives tighter requirements for temperature accuracy and repeatability. Watlow's design team will work closely with your engineers to develop thermal assemblies with modular design concepts that reduce design time and costs, and provide logistics support for the final product.

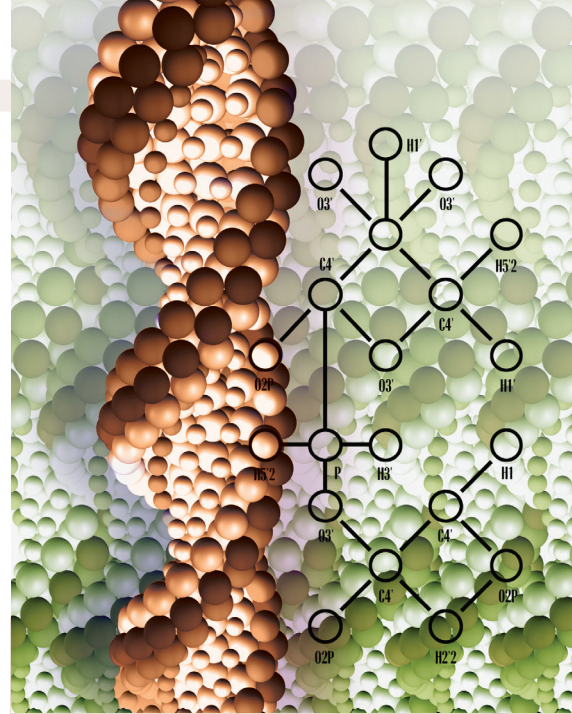

BIOTECHNOLOGY AND CLINICAL DIAGNOSTIC EQUIPMENT THAT INTEGRATE WATLOW THERMAL SOLUTIONS

- Blood gas analyzers
- Clinical chemistry analyzers
- Coagulation analyzers
- Genetic analyzers for DNA sequencing
- Hematology analyzers
- Hybridization ovens
- Immunoassay analyzers
- Integrated systems analyzers
- In-vitro diagnostics (IVD)
- Lab-on-a-chip thermal systems
- Magnetic resonance imaging (MRI)
- Thermal cyclers

ULTRAMIC[®] ADVANCED CERAMIC HEATERS

FEATURES AND BENEFITS

HIGH DIELECTRIC STRENGTH

- Delivers superior electrical performance
- Ensures low leakage current < 10 μ A at 500VAC and 100°C (212°F)
- Enables high breakdown voltage >2000VDC

ROBUST ALUMINUM NITRIDE (AlN) CERAMIC CONSTRUCTION

- Provides a clean, non-contaminating heat source
- Offers homogeneous assembly with no open porosity for atmospheric or vacuum applications

HIGH THERMAL CONDUCTIVITY AND WATT DENSITIES

- Enables ultra-fast temperature ramp rate of up to 150°C (270°F) per second
- Provides uniform temperatures across the heater's surface
- Allows for quick cool down

TYPE K THERMOCOUPLE INTEGRATED WITH ASSEMBLY

- Provides process control or high limit safety protection
- Improves accuracy with optimized temperature sensing
- Delivers a high response rate in ramping applications

AGENCY RECOGNITION AND SAFETY COMPLIANCE

- UL[®]
- CE
- RoHS

ULTRAMIC[®] advanced ceramic heaters are designed for medical devices and clinical applications where electrical safety, small size, fast temperature ramp rates and cleanliness are critical. Applications such as respiratory therapy equipment, clinical diagnostic instrumentation and DNA analysis are an ideal match for ULTRAMIC's capabilities.

Constructed using aluminum nitride (AlN), ULTRAMIC advanced ceramic heaters incorporate a proprietary heating element to provide maximum performance and long life in demanding applications. The robust ceramic construction creates a clean, non-contaminating heat source that is resistant to chemical attack and moisture ingress.

A very low leakage current, as low as 1 μ A even at standard line voltages, can eliminate the need for step-down isolation transformers or low-voltage power supplies which add size, weight and cost to the system.

Available in a variety of miniature shapes and sizes, fast responding ULTRAMIC heaters feature watt densities, up to 1000 W/in² (155 W/cm²) and deliver operating temperatures as high as 600°C (1112°F) for optimal performance and equipment effectiveness.

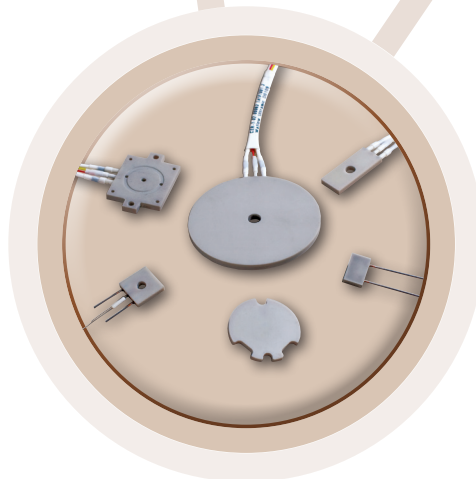

Watlow ULTRAMIC advanced ceramic heaters provide maximum performance and long life when patient safety and cleanliness are application critical.

FIREROD® CARTRIDGE HEATERS

Watlow's FIREROD® cartridge heaters are designed for medical equipment including baby incubators and kidney dialysis machines and injector ports. Incorporating engineering excellence and supported by more than half a century of solid industry performance, Watlow's FIREROD cartridge heater is an excellent solution for medical applications that require heating aluminum, stainless steel or other metal subassemblies. Built using premium materials and tight manufacturing process controls, the FIREROD cartridge heater provides superior heat transfer and uniform temperatures.

Available in both imperial and metric sizes with high, medium and low watt density units, FIREROD is one of the most versatile and widely-used cartridge heaters. Its robust construction and operating characteristics help to reduce downtime and heater replacement costs. Service life of FIREROD heaters has proven to be 12 times longer than other cartridge heaters, even at high temperatures.

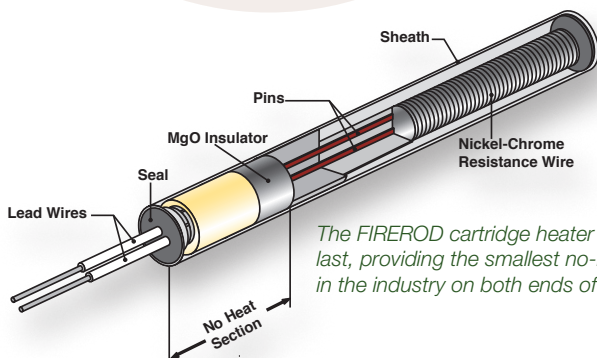
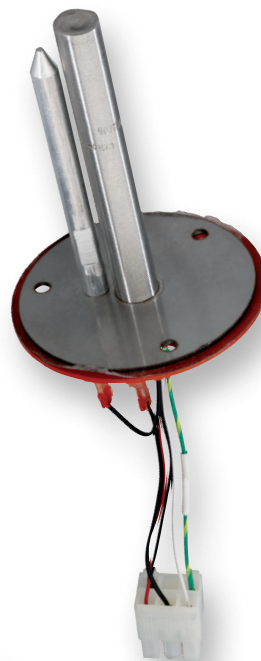
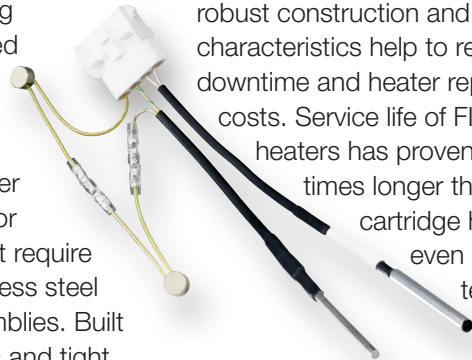

The FIREROD cartridge heater is built to last, providing the smallest no-heat section in the industry on both ends of the heater.

FEATURES AND BENEFITS

MAGNESIUM OXIDE INSULATION OF SPECIFIC GRAIN AND PURITY

- Results in high dielectric strength and contributes to faster heat up

MINIMAL SHEATH SPACING BETWEEN THE ELEMENT WIRE AND SHEATH

- Prolonged heater life due to lower internal temperature
- Special low leakage designs available

SWAGED CONSTRUCTION

- Delivers higher watt density up to 400 W/in² (62 W/cm²)
- Enables higher temperature capacity
- Provides maximum heat transfer efficiency
- Increases dielectric strength

INTERNAL THERMOCOUPLE OPTION

- Allows use in space-restricted applications

SPECIAL LOW MASS 1/8 IN. DIAMETER AVAILABLE

- Provides superior performance in a small package
- Delivers better heat transfer
- Enables faster response time

AGENCY RECOGNITION AND SAFETY COMPLIANCE

- UL®
- UL® Type LL for low leakage applications
- CE
- RoHS



Blood warmers, IV fluid warmers, blood transfusion equipment, fluid syringe heating and contrast media heating are all used to warm fluids injected into a patient.

Watlow's FREEFLEX® heater is ideally suited for automated fluid delivery that requires uniform heat transfer. Its thin, bendable properties allow it to fit directly into applications that require complex shapes and geometries. FREEFLEX heaters used for fluid delivery provide reliable, fast heat up and cool down rates, uniform heat distribution and high watt densities.

The FREEFLEX heating element and sensor directly contact the perimeter of the tubing to effectively transfer energy to fluids within an inside diameter. Its ability to move fluids within diameters as small as 0.8 mm ($1/32$ in.) and operate up to a maximum temperature of 100°C (212°F) make this FREEFLEX heater ideal for reagent transfer.

This innovative design enables efficient, responsive heating and temperature control over a portion or the entire length of the tube contents. The element is evenly wound to ensure reliable, close contact for uniform heating where needed.

A flexible, durable jacket covers the wound element, allowing the tubing to flex and move. The result is fluid delivery to multiple locations from a single supply source. For stationary applications, FREEFLEX heated tubing is conveniently routed around system components. For added versatility, FREEFLEX is available with optional thermocouples or thermistor temperature sensors integrated with the thermal system.

FEATURES AND BENEFITS

FLEXIBLE HEAT-UP AND TRANSPORT SYSTEM

- Eliminates the need for heated reservoir systems in many applications

DIRECT CONTACT BETWEEN THE HEATING ELEMENT AND TUBING

- Provides efficient, highly responsive heating

AVAILABLE IN THREE CONFIGURATIONS

- Flexible design allows tubing to flex, coil or bend around system components, enabling convenient retrofits
- Pre-formed design extends the tube length in smaller volume
- Molded design offers a compact heating assembly for easy installation

INTEGRAL SENSORS

- Maintain close control of the heater and fluid temperatures

LOW VOLTAGE DESIGN

- Ensures safety

MINIATURE SIZES WITH AN INSIDE DIAMETER AS SMALL AS 0.88 MM ($1/32$ IN.)

- Heats and transports fluids within tiny spaces

FREEFLEX heaters reduce power requirement as heat is available directly where it is needed without any temperature loss.

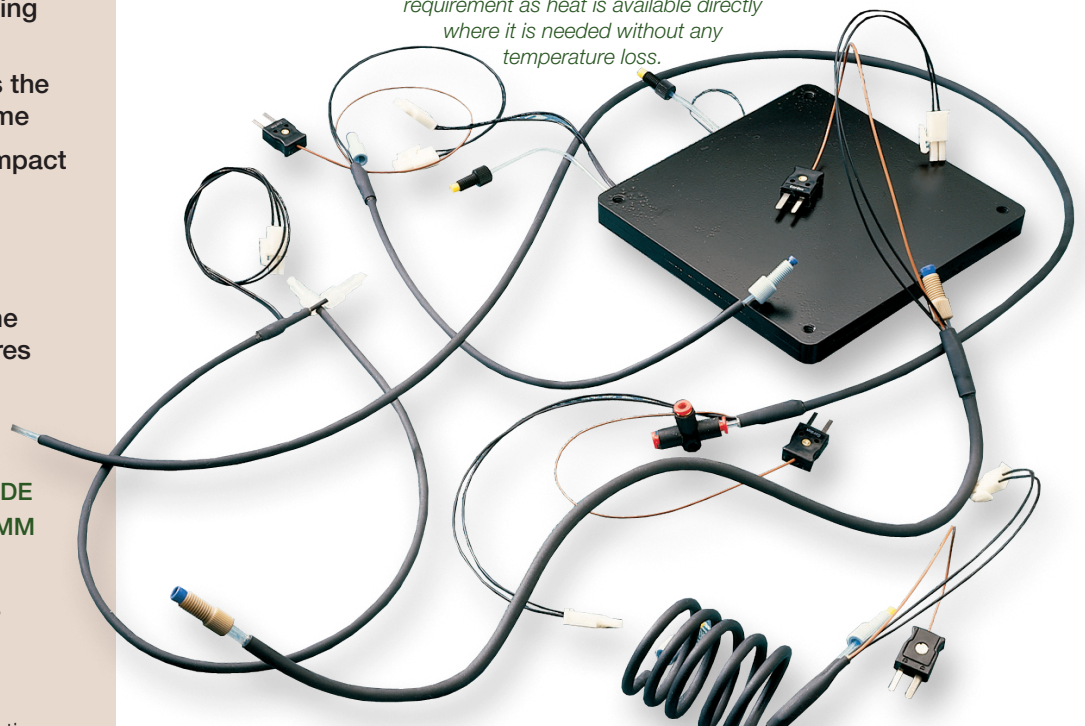

SYRINGE HEATERS

Watlow syringe heaters were developed specifically to match the unique needs of medical injection applications. Fluid and drug delivery that maintains precise liquid temperatures and reduces fluid viscosity maximizes patient comfort and decreases risk. Body temperature injections are more easily introduced, particularly for patients in a frail or distressed condition. Used in contrast delivery system applications for angiography and CT scanning, Watlow syringe heaters maintain temperature consistency and reduce viscosity variation to increase diagnostic accuracy.

Flexible and adaptable, Watlow's syringe heaters deliver superior operational performance, long life and can be customized to meet most original equipment manufacturer (OEM) requirements.

The Watlow syringe heater is available in two configuration types with an optional, repeatable temperature sensing controller. The silicone/wire configuration accommodates varying syringe size needs. The translucent, high-tech laminate construction of the polycarbonate/foil design enables fluid levels and air bubbles to be easily viewed and monitored. Its smooth outer surface and radius on all inside corners facilitate easy cleaning.

An overmold design houses the optional electronic controller and/or temperature sensor to allow trouble-free servicing and extend heater life. The overmold can be modified and color matched for a seamless, integrated appearance.

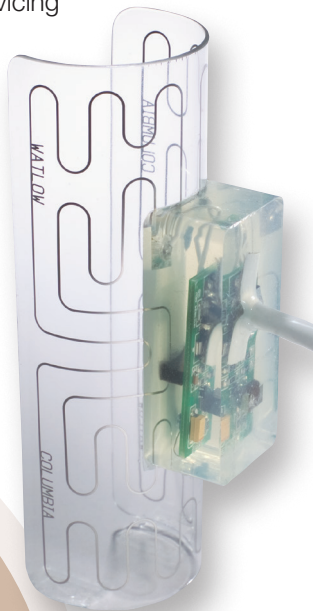

FEATURES AND BENEFITS

OPTIONAL, PRECISE, REPEATABLE TEMPERATURE SENSING CONTROL WITH A FULLY REDUNDANT SYSTEM

- Precise fluid temperatures maximize patient comfort and minimize risk

TEMPERATURE STABILITY YIELDS VISCOSITY STABILITY

- Ensures accuracy and repeatability of test results

DURABLE, RELIABLE HEATER DESIGN AND CONSTRUCTION

- Fits snugly to the outside surface of the syringe to ensure precise heating
- Formed heater body holds firmly to the syringe center
- Reinforced power cord to meet pull strength requirements up to 89 N (20 lbf)
- Less equipment down time minimizes the need to reschedule procedures
- Carries a longer product life than bimetal thermostat construction

SILICONE/WIRE CONFIGURATION

- Adaptable and flexible design accommodates various syringe sizes

POLYCARBONATE/FOIL CONFIGURATION

- Clear material enables easy viewing and monitoring for air bubbles
- Customizable design meets most original equipment manufacturer requirements
- Overmold can be modified and color matched for a seamless, integrated appearance



POLYIMIDE FLEXIBLE HEATERS

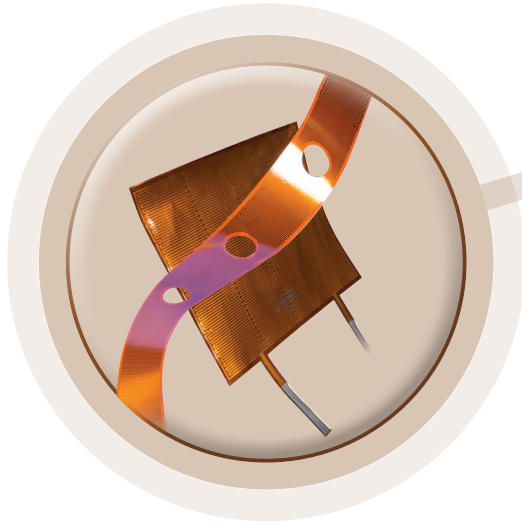

Solvent-resistant polyimide is a thin, lightweight organic polymer film that provides excellent tensile strength, tear resistance and dimensional stability. Watlow's polyimide heater is ideal for IV heaters, respiratory therapy units and blood, fluid and endoscope warmers. It is also used for DNA analysis equipment and clinical diagnostic instrumentation that require low outgassing in a vacuum or resistance to radiation, fungus and chemicals.

Watlow uses an enhanced precision registration cutting process to provide polyimide heaters with tight tolerance to fit exact application and power needs. Precise temperature distribution and proper bonding or attachment methods to subassemblies can reduce installation costs. Watlow's engineering team can engineer a heater design and develop a production schedule that best fits your needs.

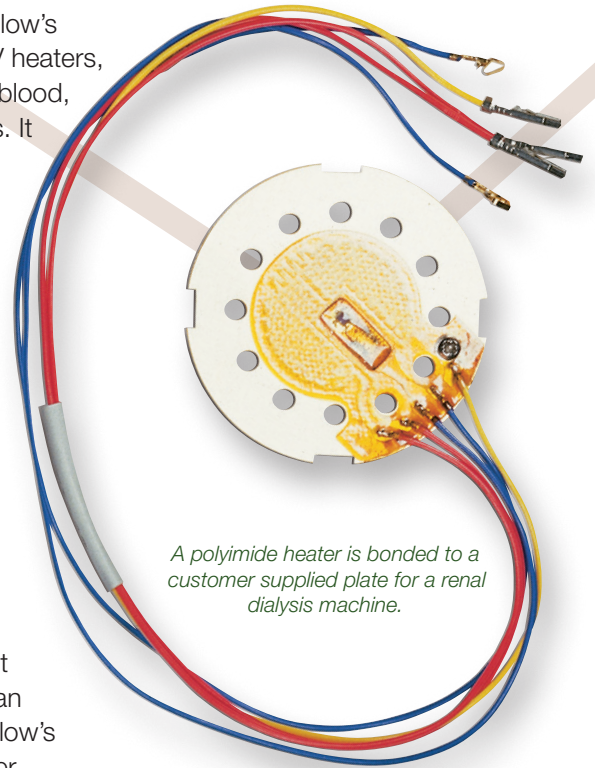

A polyimide heater is bonded to a customer supplied plate for a renal dialysis machine.

FEATURES AND BENEFITS

ETCHED FOIL PROVIDES HIGH-TOLERANCE PHYSICAL AND ELECTRICAL PROPERTIES

- Thermal stability across a wide temperature range up to 200°C (392°F)
- High dielectric strength: 5000 volts per 0.025 mm (0.001 in.)
- Flexible: minimum bend radius of 0.8 mm (1/32 in.)
- Material easily wipes clean

TRANSPARENT POLYIMIDE MATERIALS

- Allows internal construction to be easily inspected

AGENCY RECOGNITION AND SAFETY COMPLIANCE

- UL®
- C-UL®
- Facilities easy agency approval for finished design



A polyimide lead extension provides a flexible and robust power connection to the heater assembly used in DNA test equipment.

SILICONE RUBBER HEATERS

Rugged, yet thin, lightweight and flexible, Watlow silicone rubber heaters put heat where it is needed to improve heat transfer, speed warm-ups and decrease wattage requirements. Fiberglass-reinforced silicone rubber provides dimensional stability without sacrificing flexibility. A minimal amount of material separates the element from the part to enable rapid and efficient heat transfer.

Silicone rubber heaters are used in medical applications for blood analyzers, infant warmers, respiratory therapy units, test tube heaters, continuous and variable positive airway pressure (CPAP and VPAP) machines, and can be formed to fit many custom designed device components. They can be supplied as a complete thermal assembly to reduce installation costs. With vast global resource capabilities, Watlow can accommodate a few quick-turn prototypes and ramp up to a production volume of thousands of heaters per year.

Watlow silicone rubber heaters can be designed to fit the exact shape and size for specific applications.



FEATURES AND BENEFITS

DESIGNED TO FIT EXACT SHAPE AND SIZE REQUIREMENTS

- Conforms to equipment configuration for precise power where needed.
- Power density can be easily distributed to provide superior temperature distribution
- Available in many design configurations to accommodate most geometries

MOISTURE, ABRASION AND CHEMICAL- RESISTANT SILICONE RUBBER MATERIAL

- Extends heater longevity

MANY COMBINATIONS OF ELEMENT AND SILICONE RUBBER CONSTRUCTIONS ARE AVAILABLE

- Heater design can best match application needs

VULCANIZED ADHESIVES OR FASTENERS

- Sets up easily and provides strong bonding between the heater and the part

PROCESS TEMPERATURE RANGE

- Up to 220°C (428°F)

AGENCY RECOGNITION AND SAFETY COMPLIANCE

- UL®, C-UL®
- VDE, CE
- Facilitates easy agency approvals of finished equipment

Medical and Clinical Thermal Solutions

WATROD™ AND FIREBAR® TUBULAR HEATERS



Watlow's round WATROD™ and flat FIREBAR® tubular heating elements are used in both radiant and convection modes to provide uniform temperature profiles. They are ideal for use in demanding applications, such as those used in baby incubators, which require uniform temperature as well as minimal surface material loss while reducing leakage to ground.

With more than 30 years' experience, Watlow can design the optimum incubator solution to match your application needs.

Tubular elements and assemblies are also used in sterilizers and in medical applications to heat liquids in non-invasive surgical equipment.

FEATURES AND BENEFITS

PRECISION BENDING WITH INTRICATE GEOMETRICAL FORMATIONS

- Enables the heating element to be designed around available space to maximize efficiency
- Provides reliable heater life

INTERNAL THERMOCOUPLE TEMPERATURE SENSOR

- Reduces assembly costs and is more responsive and accurate compared to separate surface mount thermocouple temperature sensors

HIGH TEMPERATURE, MOISTURE-RESISTANT SEALS

- Protect against moisture contamination and are UL® rated up to 371°C (700°F)
- Minimize low leakage current at high temperatures

MAGNESIUM OXIDE (MgO) INSULATION FILLED SHEATH

- Provides good dielectric strength and heat transfer

AGENCY RECOGNITION AND SAFETY COMPLIANCE

- UL®
- CSA®

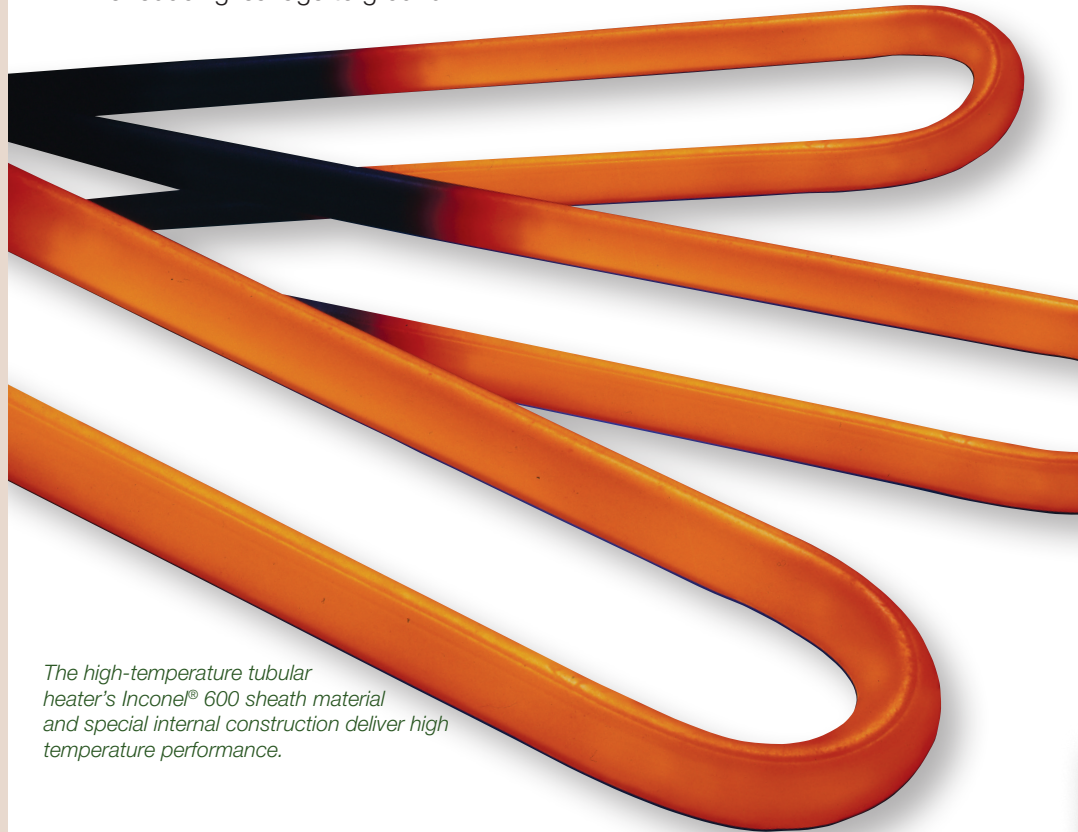

The high-temperature tubular heater's Inconel® 600 sheath material and special internal construction deliver high temperature performance.

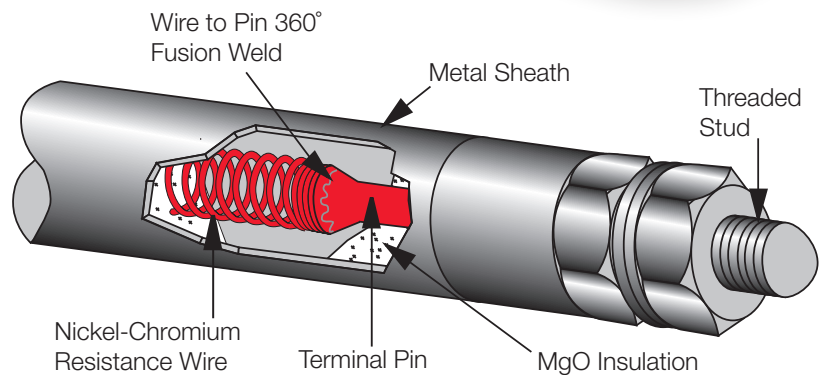

Tubular heater construction

SERIES EHG[®] SL10 PROCESS CONTROLLER AND SAFETY LIMIT

The Watlow SERIES EHG[®] SL10 process controller and safety limit is a powerful system that integrates a heater with an adjustable set point temperature controller, high/low temperature alert, a power switching device and a high temperature safety limit.

The EHG SL10 in-line or sub-panel mount temperature controller/limit is an ideal combination for thermal management of medical applications including patient warming, fluid warming or any medical device requiring thermal management.

Its small size, adjustable or fixed set point, precise temperature control with a built in agency approved controller/safety limit enables versatility across many applications.



The EHG SL10 process controller's optional display/communication module provides easy snap on installation with the flexible heater.

FEATURES AND BENEFITS

PROCESS CONTROLLER AND SAFETY LIMIT IN ONE PACKAGE

- Meets UL[®] 1998 and CE 60730 requirements
- Easy to install, compact design
- Ethernet compatible, ISO-9001 compliant and meets all UL[®], CSA, CE and VDE certifications

OPTIONAL DISPLAY/ COMMUNICATIONS MODULE

- Enables an easy upgrade with the base device
- Offers a low cost field upgrade
- Provides easy, snap-on installation

ACCURATE AND FLEXIBLE TEMPERATURE PROCESS CONTROLLER

- Replaces problematic bi-metal thermostats with accurate electronic temperature process controllers
- Permits process parameters to be easily changed

INTEGRATED HIGH/LOW TEMPERATURE ALERT SIGNAL RELAY

- Provides a dry contact, mechanical output to activate external alarm or process function
- Signals control status with three integrated LEDs
- Allows a signal of up to 2 amperes, 30VAC/VDC, Form A to alert if the process temperature is out of range limits

HEALTH CHECK DIAGNOSTICS

- Monitors the maximum heater process temperature, maximum ambient temperature and thermocouple operation
- Provides a health check signal to inform the operator that the process is working correctly

EZ-ZONE® INTEGRATED MULTI-FUNCTION CONTROLLER

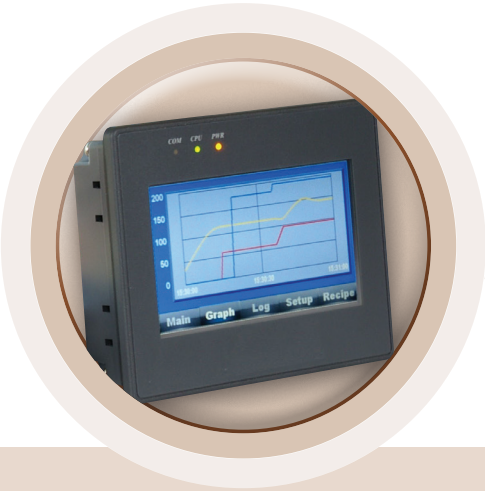

Watlow's family of EZ-ZONE® integrated multi-function controllers combine temperature, process and machine control, over- and under-temperature limit protection, high amperage power switching, safety disconnects and field communications into a single package. Offering a variety of modular form factors and display types in place of several components, the EZ-ZONE is convenient and reliable.

Watlow multi-function controllers are ideal for use in simple to complex medical applications, such as DNA processing and blood or glucose monitoring. When data logging, data storage and communications are critical, multi-function controllers provide primary and secondary temperature control with universal inputs, including thermistors. EZ-ZONE temperature controllers can be configured with an agency-approved microprocessor temperature controller and limit in one package. Simple applications requiring one loop of control and one limit loop can be achieved in as small as a 1/16 DIN package size.

The EZ-ZONE RM controller saves time, cost and space for a variety of applications. It allows multiple inputs to be mixed and matched to configure up to 152 PID loops and monitor up to 256 analog inputs. The EZ-ZONE RM controller is perfect for complex applications that require multiple sensing points and built-in logic.

The highly scalable EZ-ZONE PM panel mount controller reduces system complexity and the cost of thermal loop ownership. It can be ordered as a PID controller, as an over/under limit controller or all of these functions can be combined into the integrated controller.



The EZ-ZONE RM controller saves time, cost and space for a variety of applications.



The EZ-ZONE PM controller displays accurate and precise temperature readings.

FEATURES AND BENEFITS

EZ-ZONE RM AND EZ-ZONE PM CONTROLLER

SPECIAL OUTPUT FUNCTION ALGORITHM FOR Peltier DEVICES

- Assures that the action of the bi-directional control does not damage the peltier device

COMMUNICATES WITH AN OPERATOR INTERFACE TERMINAL (TOUCH SCREEN)

- Transmits multiple messages in various languages to medical personnel

COMBINES TEMPERATURE CONTROL AND AGENCY APPROVED FACTORY MUTUAL (FM) LIMIT IN A SINGLE PACKAGE

- Eliminates need for two discrete and independent controllers which reduces cost and space requirements

COMBINE OR ORDER OPTIONAL INTEGRATED CONTROLLER FUNCTIONS

- Saves engineering time and labor costs while shortening project schedules

ENABLES THERMISTOR INPUT

- Accuracy to display precise temperature readings

CURRENT MONITORING

- Detects heater current flow and provides alarm indication of output device or heater load failure

TEMPERATURE SENSOR TECHNOLOGIES

Achieving temperature sensor accuracy, repeatability and stability are key factors that determine how well an application performs. For some applications, such as measuring blood or body fluid temperatures, response to small changes in temperature is critical to patient health.

Watlow thermal engineers combine deep knowledge of various applications with material science, thermodynamics, electrical properties and connectivity to develop sensors for specific medical applications. The result is a sensor that consistently yields the best performance in medical device applications.

Typically integrated with a Watlow heater for clinical diagnostic applications, Watlow sensor assemblies deliver fast, accurate and repeatable temperature measurement.

Watlow's technological expertise in microprocessor technology, combined with multiple input/output applications (I/O), includes resistance temperature detectors (RTDs), thermocouple and thermistor input for precise temperature measurement.

Watlow's thermistor, RTDs and thermocouple sensor assemblies can be used in autoclaves and for fluid, air or surface measurement and monitoring applications. Thermistors are highly sensitive to small changes in temperature and maintain accurate temperatures over a limited range. RTDs are very accurate and linear over a wide operating range. Thermocouples can be produced in very small diameter packages with a flexible metal sheath.



Watlow manufactures a wide variety of sensors to match medical application needs.

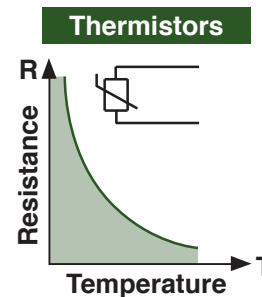
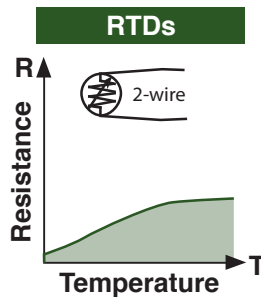
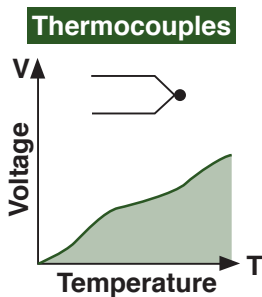

Watlow offers an array of precision sensor products



FEATURES AND BENEFITS

DESIGNED TO MAINTAIN ACCURACY OVER THE LIFE OF THE SENSOR

- Permits dependable, accurate readings to improve process control and application performance

INTERCHANGEABLE SENSOR PROBES

- Allow probes from different lots to be substituted without recalibrating to provide consistent control of critical processes

SMALL SIZE AND LOW MASS

- Enables fast response to small temperature changes ensuring application accuracy

SENSOR ASSEMBLY INTEGRATION WITH WATLOW HEATERS AND CONTROLLERS

- Provides single-source access to expert design, products and engineering services for all of your thermal system components – heaters, temperature sensors and power controllers

WATLOW FIREROD CARTRIDGE HEATER ENSURES TEMPERATURE STABILITY FOR KIDNEY (RENAL) DIALYSIS MACHINE

PROBLEM

Kidney dialysis machines purify the blood in patients whose kidneys have failed. During the kidney dialysis procedure, it is critical that body temperature is regulated to prevent the occurrence of thermal shock. A kidney dialysis machine implements a three-step thermal process that typically includes a 90°C (194°F) disinfection cycle, followed by a 37°C (98.6°F) cycle to clean the blood and a 90°C (194°F) system cleaning cycle at the end of usage each day.

APPLICATION

To ensure temperature stability and meet safety requirements, the application requires an in-line immersion heater that will not touch the perimeter of the plastic water transport tube. If the plastic tubing were to make contact with the heater, the tube would melt. Also, for the patient's safety, medical products require a low leakage current. To comply with UL® safety requirement 60601-1, a Class 1 medical device must have a leakage current of less than 300µA.

SOLUTION

Watlow's engineering team collaborated with a medical equipment manufacturer to develop a heater solution to meet all temperature and medical device requirements. A 3 mm (1/8 in.) thick flange is attached to a 16 mm (0.625 in.) diameter by 18 cm (7 in.) long FIREROD heater. The flange allows the FIREROD to remain concentric with the plastic tube. To meet leakage specifications, a Type LL, special low leakage FIREROD heater capable of maintaining leakage below 15 µA is used.

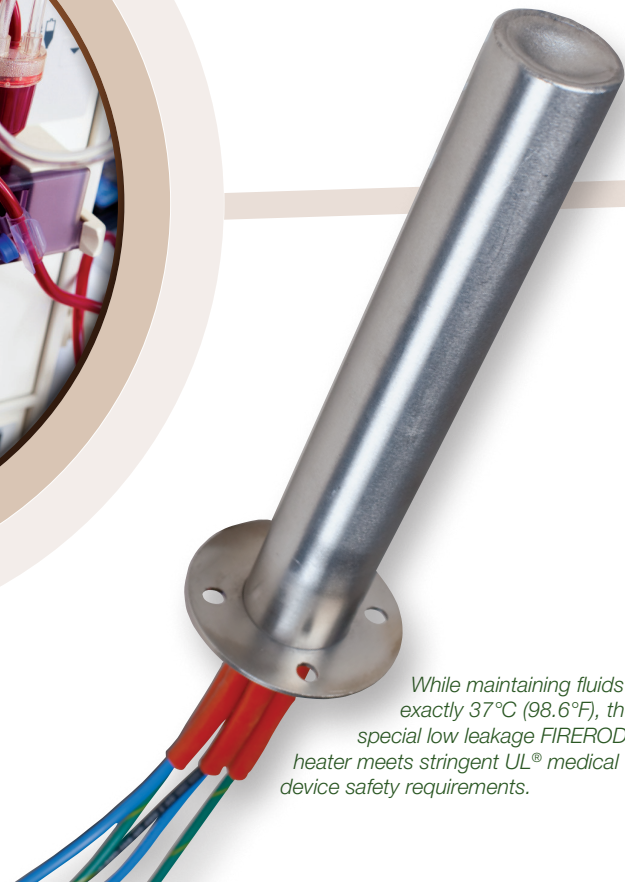
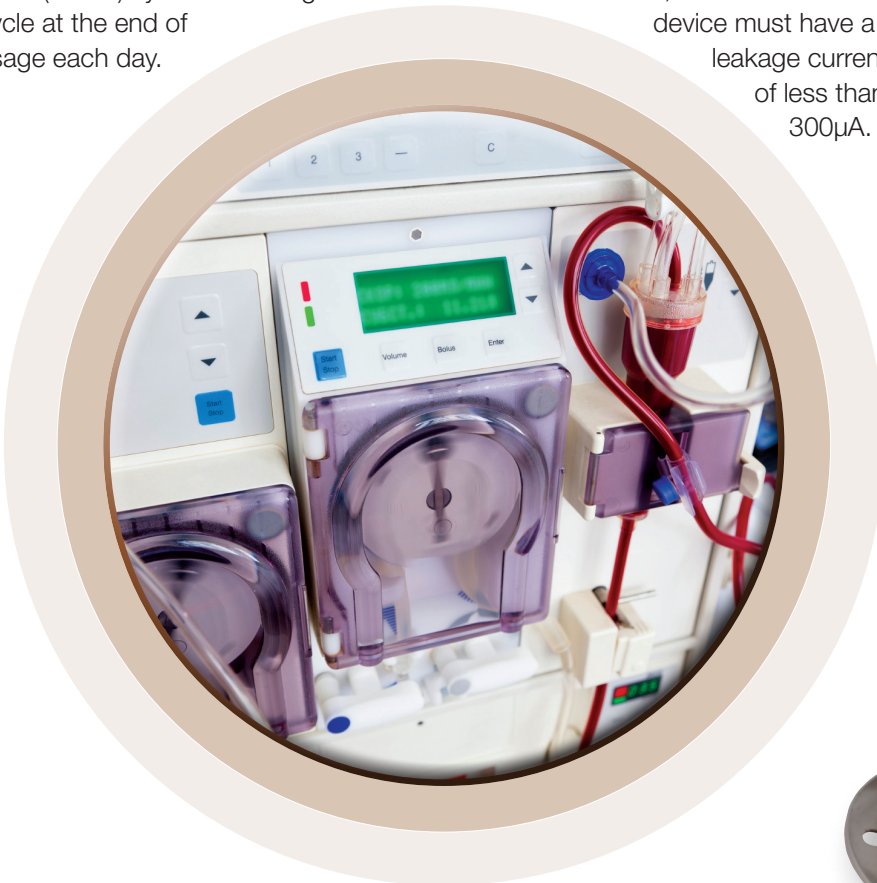

While maintaining fluids at exactly 37°C (98.6°F), the special low leakage FIREROD heater meets stringent UL® medical device safety requirements.

WATLOW'S SYRINGE HEATER INCREASES TEMPERATURE CONSISTENCY

PROBLEM

An accurate heater was needed for an injection system to view soft tissue in patients for a company that makes angiography and CT scanning equipment used by hospitals and laboratories. At 16°C (60°F), contrast media has a high viscosity which is reduced by approximately 50 percent at 37°C (98.6°F). Temperature stability is critical to delivering consistent test results. An angiogram can be used to determine if there are blockages in the veins around a patient's heart.

APPLICATION

To detect blockages, a fluid is injected into the patient's veins. This fluid is designed to be opaque to X-ray or CT scanning devices. Due to the contrast in the X-ray image, a technician can easily view the areas where the fluid has filled the normal vein and the area that the fluid is blocked from entering. This contrast media fluid is very thick in consistency (or of a high viscosity) and the consistency changes considerably with temperature. The material will change to be one-half of the 16°C (60°F) viscosity at the 37°C (98°F) viscosity. Temperature stability is critical to delivering consistent test results.

SOLUTION

The application required a robust, compact and reusable heater package to ensure accurate temperature control for the injection system and provide the capability to view the opaque contrast media used in X-ray and CT tests. Watlow designed a syringe heater to fit snugly to the outside surface of the syringe. A molded pod on the backside of the housing integrates a sensor and a custom temperature and limit controller. Prior to performing the procedure, the syringe is placed on top of the injector head, and the syringe heater is clipped to the syringe to heat the fluid to the required temperature. The heater consistently maintains the injection medium at the correct temperature.

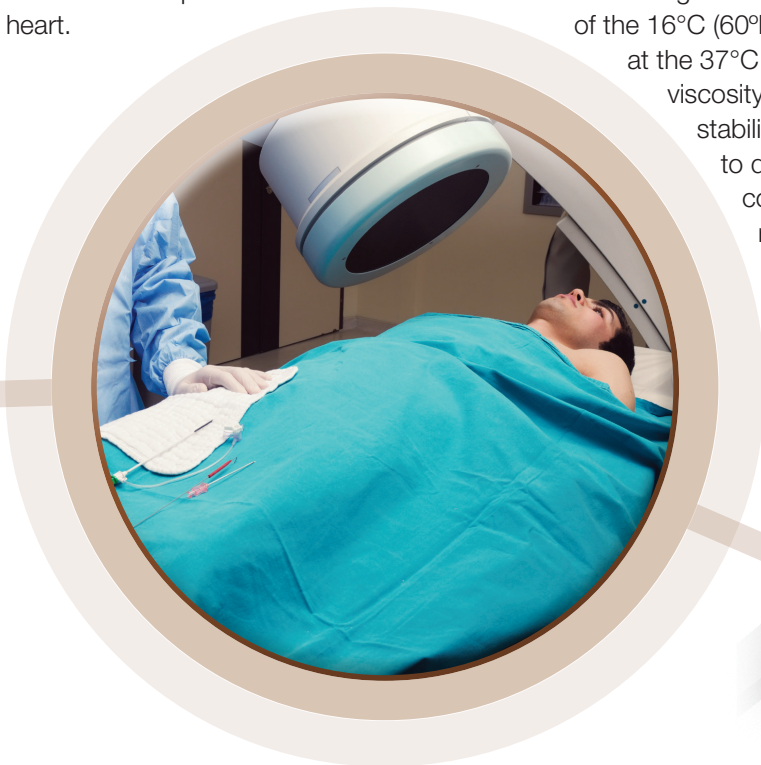

Watlow's syringe heater, attached to the outside syringe surface, heats fluid for ultimate patient comfort and safety.

ULTRAMIC ADVANCED CERAMIC HEATER AND EZ-ZONE® RM CONTROLLER IMPROVE SPEED OF CANCER SCREENING

PROBLEM

Developing innovative technology solutions that enhance diagnostic capabilities of anatomic pathology laboratories provides clinicians with rapid, reliable, actionable diagnostic information and advanced patient care.

An immunohistochemistry (IHC) machine, used to diagnose cells from cancer biopsy screenings, typically requires several days for results when traditional lab equipment is used. The customer required a solution that would enable their IHC machine to analyze cells from cancer biopsy screenings in one hour.

Receiving lab results while the patient is still in surgery enables the doctor to decide almost immediately if additional biopsies are required, eliminating the need for an additional surgery and associated costs. There is also a great relief for the patient to get results as soon as possible.

APPLICATION

An IHC machine required a low profile heater with a non-contaminating construction, fast temperature ramp rate and quick recovery time to enable the machine to generate lab results in one hour.

SOLUTION

Watlow's ULTRAMIC advanced ceramic heater and EZ-ZONE® RM controller are used with the IHC machine to radiantly heat biopsy tissue and reagents sandwiched between glass slides. Using finite element analysis (FEA), a customized resistor circuit pattern was developed to optimize temperature uniformity across the sample. The heater's integrated thermocouple works with the EZ-ZONE RM controller to accurately control the surface temperature and prevent an overtemperature condition.

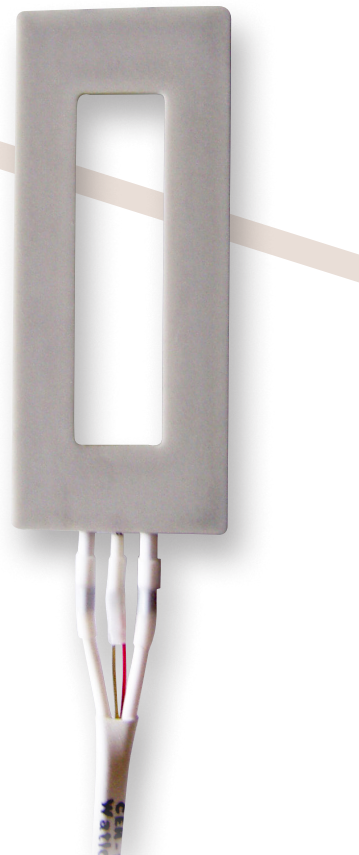
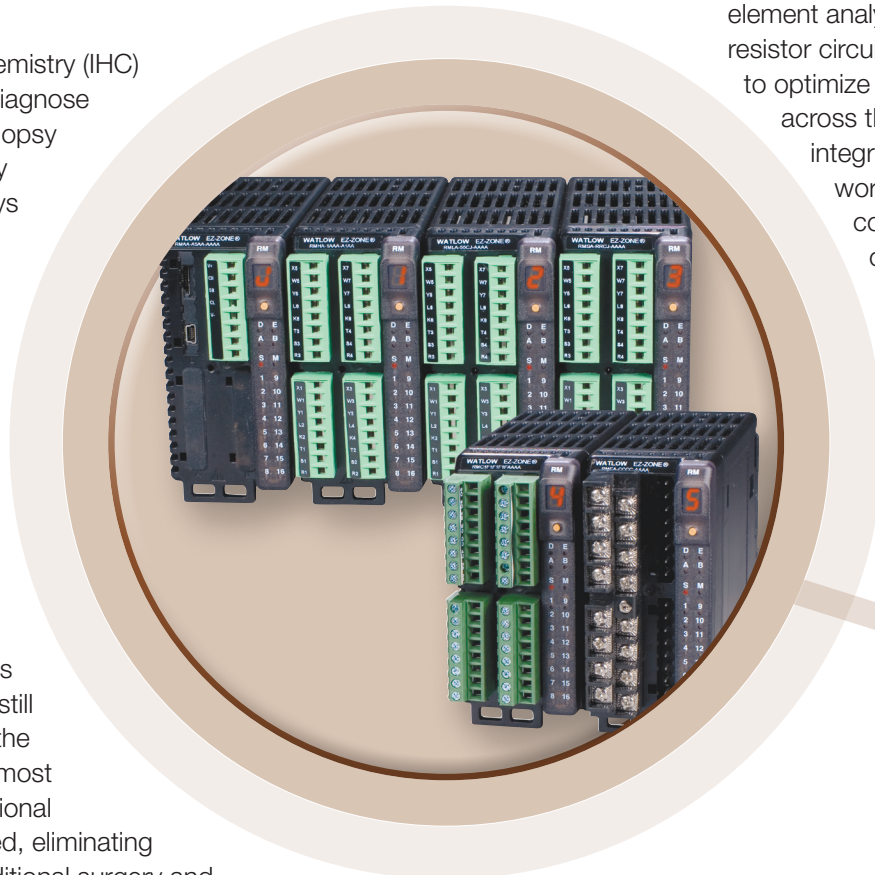

This ULTRAMIC heater assembly and EZ-ZONE RM controller enables cancer screening results to be available in 1-2 hours.

SILICONE RUBBER HEATER FOR BLOOD COAGULATION ANALYZERS

PROBLEM

Detecting and timing blood clotting is necessary for identifying diseases such as hemophilia and for patients receiving anticoagulant drugs and pre-surgical examinations. Reagents used in tests and blood plasma need warming and their temperature controlled to permit rapid and accurate processing.

APPLICATION

A blood clot sensing and recording instrument application required a high resistance heater to efficiently heat reagents for blood plasma incubation. The design required a thermal solution to reduce complexity of the equipment while providing uniform temperature distribution.

SOLUTION

A turnkey assembly was designed using two silicone rubber heaters per heating block to heat reagents and incubate the blood plasma. The silicone rubber heaters were factory vulcanized to the furnished part to achieve efficient heat transfer and lower customer installation costs. To allow line voltage operation, both heaters were wired in series. By die cutting the heaters, the cost of repeatedly meeting close tolerances of the contoured shape was reduced.

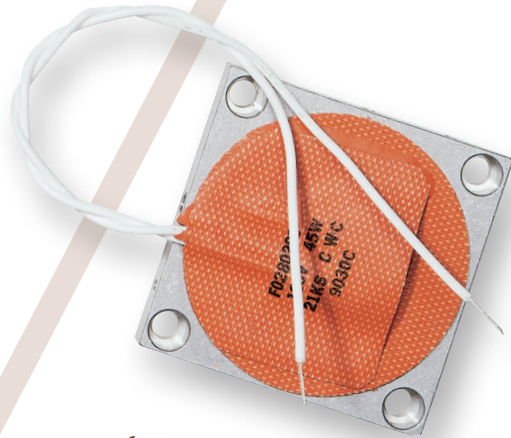

Watlow's flexible silicone rubber heaters apply heat directly where it is needed to improve heat transfer, speed warm ups and decrease wattage requirements.



About Watlow

Watlow provides best-in-class engineering expertise and leading thermal products that enable customers to thrive. Our world-class technology is offered in industrial heaters, temperature sensors and electronics and communications. Watlow engineers solutions that give our customers a competitive advantage in their respective markets.

Watlow brings its experience to numerous industries, including semiconductor processing, diesel emissions, energy and environmental technologies, foodservice equipment and life sciences to name a few.

Since 1922, Watlow has grown in product capability, market experience and global reach. The company holds more than 450 patents and employs 2,200 people working globally through eight manufacturing facilities and three advanced technology centers. Headquartered in St. Louis, Missouri with sales offices in 16 countries around the world, Watlow continues to grow. Our pride and confidence stems from thrilling our customers with our products and the Watlow experience.

Watlow Trademarks

The following are registered trademarks of Watlow Electric Manufacturing Company:

Watlow®
ULTRAMIC®
WATROD™
FIREBAR®
FIREROD®
FREEFLEX®
SERIES EHG®
EZ-ZONE®

WATROD™ is a trademark of Watlow Electric Manufacturing Company

Trademarks

UL®, C-UL® and cUR® are registered trademarks of Underwriter's Laboratories, Inc.

CSA® is a registered trademark of CSA International

Incoloy® and Inconel® are registered trademarks of Special Metals Corporation.

Your Authorized Watlow Distributor is: