



# IntelliTone™ Pro

200 LAN Toner and 200 Probe

Users Manual

August 2014, Rev. 2 9/2017

©2014, 2017 Fluke Corporation

All product names are trademarks of their respective companies.

## LIMITED WARRANTY AND LIMITATION OF LIABILITY

Each Fluke Networks product is warranted to be free from defects in material and workmanship under normal use and service unless stated otherwise herein. The warranty period for the mainframe is one year and begins on the date of purchase. Parts, accessories, product repairs and services are warranted for 90 days, unless otherwise stated. Ni-Cad, Ni-MH and Li-Ion batteries, cables or other peripherals are all considered parts or accessories. The warranty extends only to the original buyer or end user customer of a Fluke Networks authorized reseller, and does not apply to any product which, in Fluke Networks' opinion, has been misused, abused, altered, neglected, contaminated, or damaged by accident or abnormal conditions of operation or handling. Fluke Networks warrants that software will operate substantially in accordance with its functional specifications for 90 days and that it has been properly recorded on non-defective media. Fluke Networks does not warrant that software will be error free or operate without interruption.

Fluke Networks authorized resellers shall extend this warranty on new and unused products to end-user customers only but have no authority to extend a greater or different warranty on behalf of Fluke Networks. Warranty support is available only if product is purchased through a Fluke Networks authorized sales outlet or Buyer has paid the applicable international price. To the extent permitted by law, Fluke Networks reserves the right to invoice Buyer for repair/replacement when a product purchased in one country is submitted for repair in another country.

For a list of authorized resellers, visit

Fluke Networks warranty obligation is limited, at Fluke Networks option, to refund of the purchase price, free of charge repair, or replacement of a defective product which is returned to a Fluke Networks authorized service center within the warranty period.

To obtain warranty service, contact your nearest Fluke Networks authorized service center to obtain return authorization information, then send the product to that service center, with a description of the difficulty, postage and insurance prepaid (FOB destination). Fluke Networks assumes no risk for damage in transit. Following warranty repair, the product will be returned to Buyer, transportation prepaid (FOB destination). If Fluke Networks determines that failure was caused by neglect, misuse, contamination, alteration, accident or abnormal condition of operation or handling, or normal wear and tear of mechanical components, Fluke Networks will provide an estimate of repair costs and obtain authorization before commencing the work. Following repair, the product will be returned to the Buyer transportation prepaid and the Buyer will be billed for the repair and return transportation charges (FOB Shipping point).

THIS WARRANTY IS BUYER'S SOLE AND EXCLUSIVE REMEDY AND IS IN LIEU OF ALL OTHER WARRANTIES, EXPRESS OR IMPLIED, INCLUDING BUT NOT LIMITED TO ANY IMPLIED WARRANTY OF MERCHANTABILITY OR FITNESS FOR A PARTICULAR PURPOSE. FLUKE NETWORKS SHALL NOT BE LIABLE FOR ANY SPECIAL, INDIRECT, INCIDENTAL OR CONSEQUENTIAL DAMAGES OR LOSSES, INCLUDING LOSS OF DATA, ARISING FROM ANY CAUSE OR THEORY.

Since some countries or states do not allow limitation of the term of an implied warranty, or exclusion or limitation of incidental or consequential damages, the limitations and exclusions of this warranty may not apply to every buyer. If any provision of this Warranty is held invalid or unenforceable by a court or other decision-maker of competent jurisdiction, such holding will not affect the validity or enforceability of any other provision.

4/15

# Contents

Title	Page
Overview of Features .....	1
Registration .....	1
Contacting Fluke Networks .....	2
Unpacking .....	2
IT200 IntelliTone Pro LAN Kit .....	2
IT200 IntelliTone Pro LAN Toner .....	2
IP200 IntelliTone Pro Probe .....	2
Symbols .....	2
 Safety Information .....	4
Battery Status .....	4
Auto Power Down .....	4
Locating and Isolating Terminated UTP/STP Cables with the IntelliTone .....	5

Isolating Individual Wire Pairs with the SmartTone Analog Function .....	7
SmartTone Positive Identification .....	7
Validating RJ11 and RJ45 Cable Maps .....	8
Validating the Cable's Shield .....	10
Validating Ethernet Service .....	11
Testing for Continuity .....	12
Maintenance .....	12
Battery Life and Replacement .....	13
Accessories .....	14
Specifications .....	15
IT200 Toner Electrical Specifications .....	16
IP200 Probe Electrical Specifications .....	16
Feature Compatibility .....	17
Dimensions .....	17
Weight (with battery) .....	17

# IntelliTone™ Pro 200 LAN Toner IntelliTone™ Pro 200 Probe

## Overview of Features

The IntelliTone Pro 200 LAN toner and Pro 200 probe let you locate, isolate, and validate twisted pair (UTP, Cat 5e, Cat 6), coax cables (RG6, RG59, and others for CATV/CCTV), bare wire (such as speaker wire and security network wire), and Cat 3 telephone cabling. The toner also lets you validate data services.

The toner and probe feature both digital and analog toning and detection. The digital IntelliTone tone is primarily used on data cables, and on active networks. In these environments, the digital signal eliminates cable misidentification due to signal bleed and radiated or ambient noise.

The analog tone is primarily used on voice cables, and on bare wire. The SmartTone™ analog technology will change cadence when a pair is shorted at the far end. This makes exact pair identification easy and precise.

The IntelliTone feature also lets you use the toner and probe to validate and troubleshoot wiring on RJ11 and RJ45 cables.

The toner detects Ethernet service and indicates active pair number on Ethernet circuits.

The toner and probe also provide standard functions such as visual and audible signal strength indication, digital toning/detection, SmartTone analog toning/detection, and continuity testing.

## Registration

Registering your product with Fluke Networks gives you access to valuable information on product updates, troubleshooting tips, and other support services. To register, fill out the online registration form on the Fluke Networks website at

## Contacting Fluke Networks



Fluke Networks operates in more than 50 countries worldwide. For more contact information, go to our website.

## Unpacking

The IntelliTone products come with the accessories listed below. If an accessory is damaged or missing, contact the place of purchase immediately.

### IT200 IntelliTone Pro LAN Kit

- IT200 Toner with 9 V battery
- IP200 Probe with 9 V battery
- 2 RJ11 to RJ11 patch cords
- 2 RJ45 to RJ45 patch cords

- Test lead set, banana jacks to alligator clips
- F connector adapter, female to female
- Quick Reference Guide

### IT200 IntelliTone Pro LAN Toner

- IT200 Toner with 9 V battery
- 1 RJ11 to RJ11 patch cord
- 1 RJ45 to RJ45 patch cord
- Test lead set, banana jacks to alligator clips
- F connector adapter, female to female
- Quick Reference Guide





### IP200 IntelliTone Pro Probe





- IP200 Probe with 9 V battery
- Quick Reference Guide

## Symbols

Table 1 describes the symbols used on the tester and in this manual.

**Table 1. Symbols**

	Warning or Caution: Risk of damage or destruction to equipment or software. See explanations in the manuals.
	Warning: Risk of fire, electric shock, or personal injury.
	This equipment not for connection to public communications networks, such as active telephone systems.
	Consult the user documentation.
	<p>This product complies with the WEEE Directive marking requirements. The affixed label indicates that you must not discard this electrical/electronic product in domestic household waste. Product Category: With reference to the equipment types in the WEEE Directive Annex I, this product is classed as category 9 "Monitoring and Control Instrumentation" product. Do not dispose of this product as unsorted municipal waste.</p> <p>To return unwanted products, contact the manufacturer's web site shown on the product or your local sales office or distributor.</p>

	40 year Environment Friendly Use Period (EFUP) under China Regulation - Administrative Measure on the Control of Pollution Caused by Electronic Information Products. This is the period of time before any of the identified hazardous substances are likely to leak out, causing possible harm to health and the environment.
	Conformite Europeene. Conforms to the requirements of the European Union and the European Free Trade Association (EFTA).
	Korea (KCC): Class A Equipment (Industrial Broadcasting and Communication Equipment). Class A: Equipment meets requirements for industrial electromagnetic wave equipment and the seller or user should take notice of it. This equipment is intended for use in business environments and is not to be used in homes.
	Conforms to relevant Australian standards.

## Safety Information

### Warning

To prevent possible fire, electric shock, or personal injury:

- Never use the toner, probe, or test leads if they are damaged. Inspect the cases and test leads for damage before use.
- Never open the case except to change the battery; no user-serviceable parts are inside.
- Turn off the toner or probe and disconnect all test leads before replacing the battery.
- Use only a 9V battery, properly installed in the case, to power the toner and probe.
- If this equipment is used in a manner not specified by the manufacturer, the protection provided by the equipment may be impaired.

### Caution

- Avoid touching the probe tip to patch panel connections and using the tip to dig into cable bundles. Doing so regularly may damage the probe tip over time.

- To avoid unreliable test results, replace the battery as soon as the low battery indication appears.

## Battery Status

LEDs on the toner and probe light for 1 second at power on to indicate the battery status:

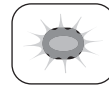

Toner battery status  
LED



Probe battery status  
LED

**Green:** Battery is good.

**Yellow:** Battery is marginal.

**Red:** Battery is low.

See "Battery Life and Replacement" on page 16 for more information on the battery.



## Auto Power Down



The toner turns off automatically after approximately 2 ½ hours of inactivity. The probe turns off automatically after 1 hour of inactivity.





To reactivate the toner or probe, turn the rotary switch to any position except **OFF**.

## Locating and Isolating Terminated UTP/STP Cables with the IntelliTone



The IntelliTone Pro toner provides two toning modes for locating and isolating cables: one digital tone  and the SmartTone analog tones (500 Hz to 1200 Hz) .

With the toner set to digital tone mode, the probe can be set to either locate  or isolate .

Both toning signals are available at all connectors on the toner.

The digital tone  is optimized for 4 pair UTP data environments and the SmartTone analog tone  is optimized for two wire locating.

To locate and isolate cables using the digital tone, do the following:

- 1 Connect the IT200 toner to a jack or punch-down block as shown in Figure 1.
- 2 Turn the toner's rotary switch to .
- 3 Turn the IP200 probe's rotary switch to  (locate).

- 4 Use the probe to find the general location of the tone at a cable rack, patch panel, or behind a wall. The **SYNC LED** lights up green when the probe is receiving the IntelliTone signal.

In locating mode, the probe's LEDs light up from 1 to 8 as the signal strength increases. The higher the number, the stronger the signal.

### Note

*If you cannot locate the IntelliTone signal on 2-conductor cables, the cable may be shorted. Use the cable map test (page 8) to test for shorts on cables with RJ11 and RJ45 connectors. Use the continuity test (page 12) to check for shorts on coax and non-terminated cables.*

- 5 Turn the probe's rotary switch to  (isolate).
- 6 Use the probe to isolate the tone source in the cable bundle or at the patch panel. The **SYNC LED** lights up green when the probe is receiving the IntelliTone signal.

In isolating mode, the probes LEDs light up from 1 to 8 as the signal strength increases.

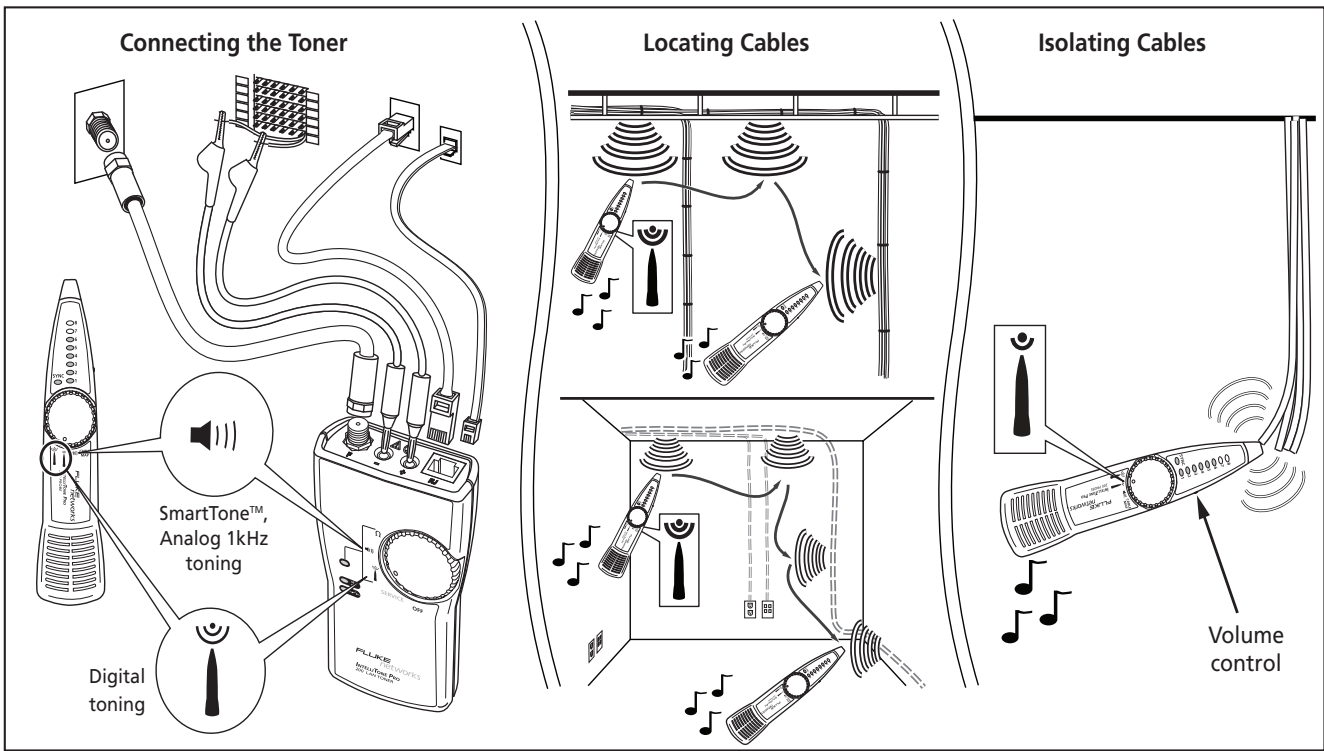

ASH04.EPS

Figure 1. Locating and Isolating Cables

## Isolating Individual Wire Pairs with the SmartTone Analog Function

The  position on the IntelliTone probe and toner lets you use the probe to trace using an analog tone.

SmartTone is intended for use on dry pairs of wires that are un-terminated at both ends of the run. It is not intended to be used on live wires with a DC power source (e.g., live telephone lines), nor will it work on wire pairs that are carrying AC signals. SmartTone works on many types of wire pairs including twisted pair, house wiring, and coax (the shield is one wire and the center conductor is the other wire of the pair).

### SmartTone Positive Identification

- 1 The toner red lead must be connected to one of the wires of the pair, and the black lead must be connected to the other wire of the pair.
- 2 Put the toner and probe in the  position.
- 3 At the far end of the cable run, place the probe near the wires you are tracing. Pick the pair that gives the loudest signal in the toner speaker.
- 4 Short and release the two wires of the pair. If you hear a change in the pattern of the tone, then you have located the target pair of wires.

If you don't hear a change in the tone pattern, then pick a different pair and try again until you find the pair that causes the tone pattern to change.

## Validating RJ11 and RJ45 Cable Maps

You can use the IT200 toner and IP200 probe to validate the cable map on RJ11 and RJ45 connectors. The cable map function finds the most common wiring faults on twisted pair cabling: shorts, opens, and crossed pairs.

- 1 Connect an IT200 toner to a RJ11 or RJ45 jack, as shown in Figure 2.
- 2 Turn the toner's rotary switch to .
- 3 If necessary, use the IP200 probe to locate the correct connector at the other end of the cabling, as described in the previous section.
- 4 Connect the IP200 probe to the RJ11 or RJ45 jack; then turn the probe's rotary switch to **CABLE MAP**.
- 5 The probe's LEDs and beeper indicate the cable map, as follows:
  - The number of each LED corresponds to a pin on the connector. You can enable the **SYNC** LED to validate the shield. See "Validating the Cable's Shield" on page 10.

- Each LED that corresponding to an active pin flashes briefly, then should light for about 1 second. The brief flash shows which LED is next in the sequence.
- The probe also beeps in different tones to indicate good wiring, miswires, shorts, and opens.
- Miswire: If one LED flashes briefly, then another LED lights for one second, the wire for the first LED is miswired to the pin for the second LED.
- Short: If two LEDs turn on for 1 second at the same time, those two pins are shorted together. If more than 2 wires are shorted together, the LEDs for the shorted pins indicate opens.
- Open: If an LED flashes briefly, then no LEDs turn on, that pin is open.

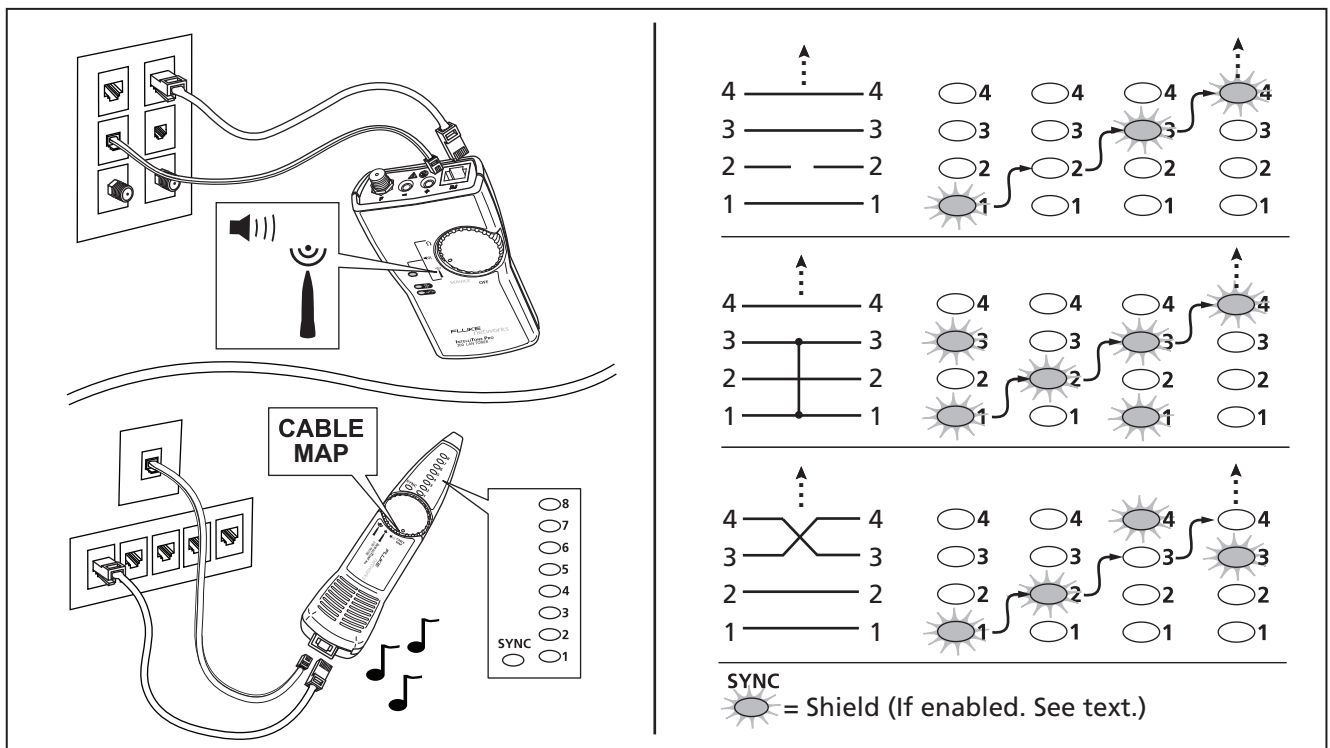

ASH05.EPS

Figure 2. Validating Cable Maps

## Validating the Cable's Shield

To use the probe's **SYNC** LED for shield validation during cable map tests, do the following:

- 1 Remove the battery door and disconnect the battery from the probe, as described under "Battery Life and Replacement" on page 13.
- 2 Turn the probe's rotary switch to **CABLE MAP**.

*Note*

*The battery must be disconnected from the probe for at least 30 seconds.*

- 3 Replace the battery and battery door.

The **SYNC** LED will now indicate a good, open, or shorted shield as described in the previous section.

To disable shield validation via the probe's **SYNC** LED, do the following:

- 1 Remove the battery door and disconnect the battery from the probe.
- 2 Turn the probe's rotary switch any position except **CABLE MAP**.

*Note*

*The battery must be disconnected from the probe for at least 30 seconds.*

- 3 Replace the battery and battery door.

## Validating Ethernet Service

The toner detects link pulses for 10BASE-T, 100BASE-TX, and 1000BASE-T Ethernet service on pins 1, 2 and 3, 6 of its RJ45 jack.

- 1 Turn off the toner.
- 2 Connect the toner to the circuit as shown in Figure 3.
- 3 Turn the toner's rotary switch to **SERVICE**.
- 4 The Ethernet LED indicates service on pins 1, 2 or 3, 6 as shown in Figure 3.

The toner checks for continuity between pins 4, 5. Continuity indicates the toner is connected to a network device that is turned off.

The toner checks for continuity between the red and black test leads and across the middle pair of the RJ45/RJ11 jack (line 1).

### Note

*If the Ethernet LED alternates between red and green, the Ethernet service is Auto-MDIX.*

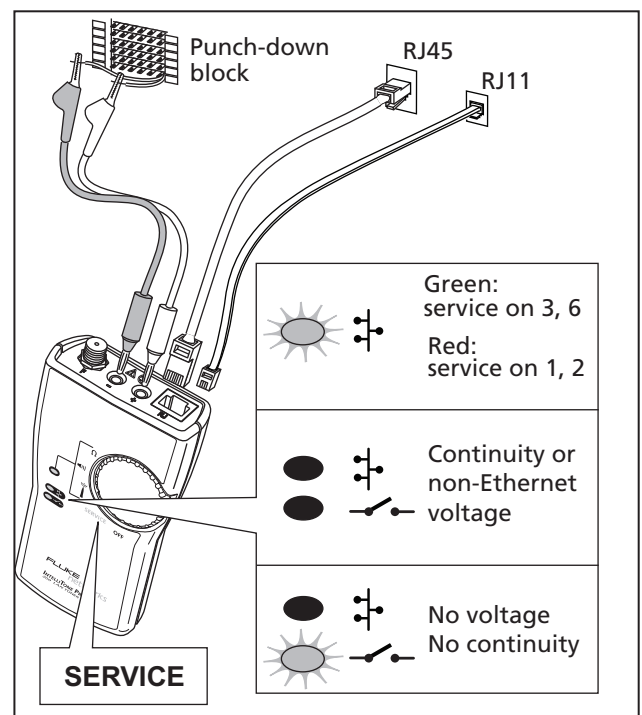

ASH01.EPS

Figure 3. Validating Ethernet Service

## Testing for Continuity

You can use the toner to test circuits and components for continuity.

- 1 If you are testing a circuit, verify that it is not powered. Use the toner's continuity  $\Omega$  function to check for continuity. Use a voltage meter to check other types of circuits for power.
- 2 Turn off the toner.
- 3 Connect the toner to the circuit or component as shown in Figure 4.
- 4 Turn the toner's rotary switch to  $\Omega$ .
- 5 The  LED indicates an open or closed circuit as shown in Figure 4.

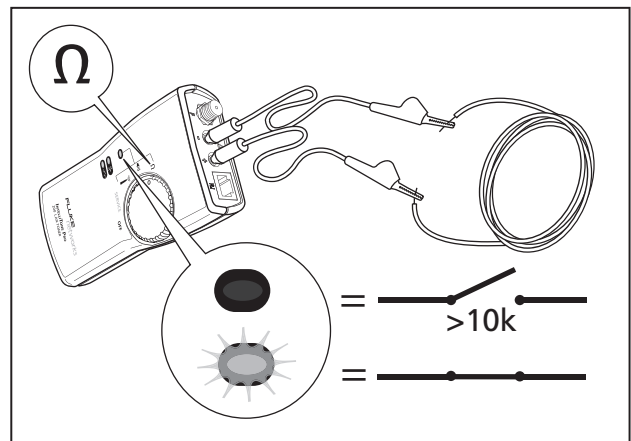

Figure 4. Continuity Test

## Maintenance

Clean the case with a soft cloth dampened with water or a mild soap solution.

### Caution

To avoid damaging the case, do not use solvents or abrasive cleansers.



### Battery Life and Replacement

The toner and probe batteries last for about 20 hours of typical use.

Figure 5 shows how to replace the battery in the toner and probe.

#### Note

*The position of the probe's rotary switch when the battery is replaced enables or disables shield validation for cable map tests. See "Validating the Cable's Shield" on page 10.*

#### **Warning**

To avoid possible electric shock or personal injury:

- Turn off the toner or probe and disconnect all test leads before replacing the battery.
- Use only a 9 V battery, properly installed in the case, to power the toner and probe.

#### **Caution**

To avoid unreliable test results, replace the battery as soon as the low battery indication appears. See "Battery Status" on page 4.

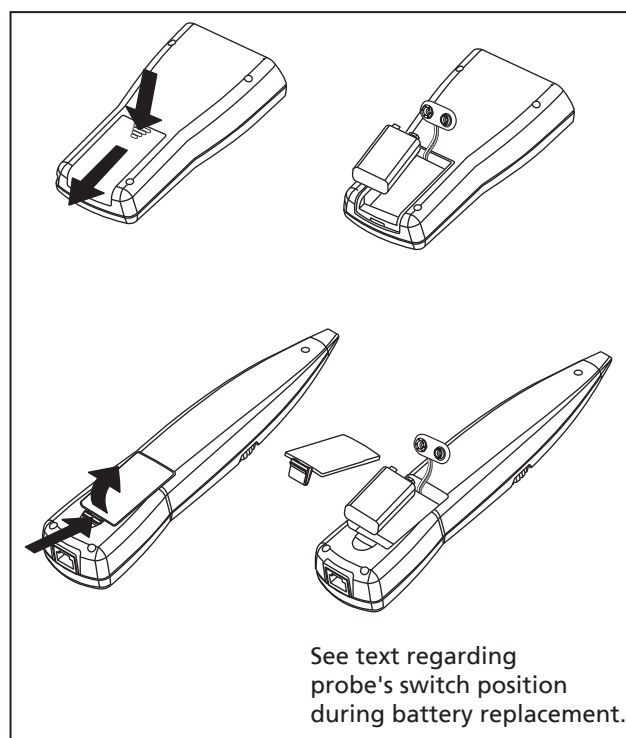

ASH10.EPS

Figure 5. Replacing the Battery

### Accessories

To order accessories (Table 2), contact Fluke Networks.

For the latest list of IntelliTone accessories and other cable testers visit the Fluke Networks website at [www.flukenetworks.com](http://www.flukenetworks.com).

Table 2. Accessories

Accessory	Fluke Networks Model or Part Number
Test lead set, banana jacks to alligator clips	MT-8203-22
Test lead set, banana jacks to alligator clips with bed of nails	MT-8203-20
Soft carrying case	MT-8202-05

## Specifications

Specifications apply at 23 °C (73 °F), unless otherwise noted.

### Environmental and Regulatory Specifications

<b>Operating temperature</b>	32 °F to 104 °F (0 °C to 40 °C)
<b>Storage temperature</b>	-4 °F to +140 °F (-20 °C to +60 °C)
<b>Operating relative humidity (% RH without condensation)</b>	95 % (50 °F to 95 °F; 10 °C to 35 °C) 75 % (95 °F to 104 °F; 35 °C to 40 °C) Uncontrolled < 50 °F (< 10 °C)
<b>Vibration</b>	Random, 2 g, 5 Hz-500 Hz
<b>Shock</b>	1 m drop test
<b>Safety</b>	IEC 61010-1 , Category: None
<b>Altitude</b>	3000 m
<b>EMC</b>	IEC 61326-1, FCC Part 15 B

### IT200 Toner Electrical Specifications

<b>Output power</b>	5 V p-p
<b>Tone frequencies</b>	IntelliTone signal: encoded digital signal Analog SmartTone signal: 500 Hz - 1200 Hz, 4 songs
<b>Battery type and life</b>	9V alkaline (NEDA 1604A or IEC 6LR61); 20 hours typical
<b>Auto power down</b>	Turns off automatically after 2.5 hours of inactivity

### IP200 Probe Electrical Specifications

<b>Tone detection</b>	Detects IntelliTone digital signal for Locate, Isolate, and CableMap functions. Detects analog SmartTone signal (500 Hz-1200 Hz) and other analog toners.
<b>Battery type and life</b>	9V alkaline (NEDA 1604A or IEC 6LR61); 20 hours typical
<b>Auto power down</b>	Turns off automatically after 1 hour of inactivity

### Feature Compatibility

IntelliTone Toner/Probe Feature	Product Compatibility	
	IntelliTone Toner and Probe	Works with Legacy Toner or Probe
IntelliTone locate mode	◆	
IntelliTone isolate mode	◆	
Cable map validation	○	
Shield validation	○	
Analog tones	◆	◆
Visual / audible proximity indicators	◆	◆
○ Requires IntelliTone IP200 probe.		

### Dimensions

Toner: 5.54 in x 2.94 in x 1.25 in  
(14.1 cm x 7.5 cm x 3.2 cm)

Probe: 8.73 in x 1.88 in x 1.26 in  
(22.2 cm x 4.8 cm x 3.2 cm)

### Weight (with battery)

Toner: 6.0 oz (170 g)

Probe: 4.7 oz (133 g)