

INSTRUCTION MANUAL



Current / Voltage Measurement & Recording

KEW LOGGER SERIES

Current Logger KEW 5010

Current&Voltage Logger KEW 5020



KYORITSU ELECTRICAL
INSTRUMENTS WORKS, LTD.

Introduction

Thank you for purchasing KEW LOGGER 5010/5020.

- Follow the procedure below and set time on the instrument before use.
 - 1) Install the KEW LOG SOFT 2 and the USB Driver according to the instructions written in the Install Manual for KEW LOG Soft 2.
 - 2) Run KEW LOG SOFT 2 once install is completed. (Refer to “4. Start “KEW LOG SOFT 2”” in the Install Manual.)
 - 3) Confirm that the LOGGER and a PC is firmly connected with a USB Cable and click “Time Synchronizing”.
 - 4) Confirm that the Logger connected with the PC is listed on the “List of detected loggers”. (The USB Driver might not be installed correctly when a message “No Logger is detected.” is displayed. Refer to the backside of the “Cautions for installing USB Driver install” or “6. Trouble shooting” (P.8) of the Install Manual and re-install the USB Driver.)
 - 5) Click “Time Synchronizing” Button while the LOGGER is powered on and checks are marked in the box for each connected LOGGER to set time.

- Read this manual and do your desirable settings. (Setting should be done by using “KEW LOG Soft 2”. Settings for some Recording modes can be done on the LOGGER.
- Read through “1. Safety Warnings” in this manual before using the LOGGER in order to ensure safe operation of the instrument.

Contents

1. Safety warnings	1
2. Features	4
3. Instrument layout	5
3-1) Panel	5
3-2) LCD	5
3-3) Displayed message	7
3-4) Function of Button	8
3-5) Range/ Filter function	9
4. Recording procedures	10
Step1: Start-up	11
Step2: Confirmation of set value	12
Step3: Preparation before a recording	13
Step4: Start of recording	15
Step5: Stop of recording	17
5. Recording modes and conditions	18
Normal recording mode	19
Trigger recording mode	22
Capture recording mode	24
Power Quality Analysis mode (only 5020)	24
6. Recording modes	25
Flashing Detection LED	28
7. Simplified Power Integration Function	31
(available on KEW LOG Soft 2)	
8. Other settings (Setting2)	34
9. Confirmation of recorded data (CALL)	39
10. Data transfer to PC	43
11. Battery replacement	45
12. Auto-power off Function & External power supply	46
13. Trouble-shooting	47
14. Specification	49



1. Safety Warnings



This instrument has been designed, manufactured and tested according to IEC 61010: Safety requirements for Electronic Measuring apparatus, and delivered in the best condition after passed the inspection. This instruction manual contains warnings and safety rules which must be observed by the user to ensure safe operation of the instrument and retain it in safe condition. Therefore, read through these operating instructions before using the instrument.

WARNING

- Read through and understand the instructions contained in this manual before using the instrument.
- Keep the manual at hand to enable quick reference whenever necessary.
- The instrument is to be used only in its intended applications.
- Understand and follow all the safety instructions contained in the manual.

It is essential that the above instructions are adhered to. Failure to follow the above instructions may cause injury, instrument damage and / or damage to equipment under test.

The symbol  indicated on the instrument means that the user must refer to the related parts in the manual for safe operation of the instrument. It is essential to read the instructions wherever the  symbol appears in the manual.

- | | |
|--|--|
|  DANGER | is reserved for conditions and actions that are likely to cause serious or fatal injury. |
|  WARNING | is reserved for conditions and actions that can cause serious or fatal injury. |
|  CAUTION | is reserved for conditions and actions that can cause injury or instrument damage. |

⚠ DANGER

- Never make measurement on a circuit in which voltage over AC300V exists.
- Do not make measurement while thunder is rumbling. Stop measurement immediately and disconnect the instrument from the object under test.
- Do not attempt to make measurement in the presence of flammable gasses. Otherwise, the use of the instrument may cause sparking, which can lead to an explosion.
- Transformer jaw tips are designed not to short the circuit under test. If equipment under test has exposed conductive parts, however, extra precaution should be taken to minimize the possibility of shorting.
- Never attempt to use the instrument if its surface or your hand is wet.
- Do not exceed the maximum allowable input of any measuring range.
- Never open the Battery Cover during a measurement.
- Verify proper operation on a known source before use or taking action as a result of the indication of the device.

⚠ WARNING

- Never attempt to make measurement if any abnormal conditions, such as broken case and exposed metal parts are found on the instrument.
- Do not install substitute parts or make any modification to the instrument. For repair or re-calibration, return the instrument to your local KEW distributor from where it was purchased.
- Do not try to replace the batteries if the surface of the instrument is wet.
- Disconnect all the cords and cables from the object under test and power off the instrument before opening the Battery Cover for Battery replacement.

⚠ CAUTION

- Put the instrument on a stable place where is free from vibrations or shocks.
- Keep away Floppy Disks, Mag Cards, PCs and Displays from the magnet, which is attached to the backside of the instrument.
- Do not expose the instrument to the direct sun, high temperature and humidity or dewfall.
- Be sure to power off the instrument after use. When the instrument will not be in use for a long period, place it in storage after removing the batteries.
- Use a cloth dipped in water or neutral detergent for cleaning the instrument. Do not use abrasives or solvents.

Safety symbols

⚠	Refer to the instructions in the manual.
◻	Indicates a Instrument with double or reinforced insulation
⚡	Indicates that this instrument can clamp on live bare conductors when the voltage to be tested is below Circuit – Ground-to-Earth voltage against the indicated Measurement Category.
~	Indicates AC
=	Indicates DC

● Measurement categories(Over-voltage categories)

To ensure safe operation of measuring instruments, IEC 61010 establishes safety standards for various electrical environments, categorized as CAT.I to CAT.IV, and called measurement categories. Higher-numbered categories correspond to electrical environments with greater momentary energy, so a measuring instrument designed for CAT.III environments can endure greater momentary energy than one designed for CAT.II.

CAT.I : Secondary electrical circuits connected to an AC electrical outlet through a transformer or similar device.

CAT.II : Primary electrical circuits of equipment connected to an AC electrical outlet by a power cord.

CAT.III : Primary electrical circuits of the equipment connected directly to the distribution panel, and feeders from the distribution panel to outlets.

CAT.IV : The circuit from the service drop to the service entrance, and to the power meter and primary over-current protection device (distribution panel).

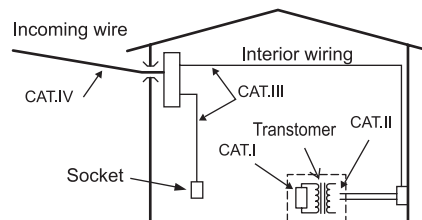

2. Features

- KEW 5020 is a Data Logger capable of measuring Leakage Current, Load Current and Voltage. (KEW5010 is for measuring Leakage Current and Load Current).
- Following sensors are used for measuring current & voltage.
 - * Leak/Load Current Clamp Sensor KEW 8146/8147/8148
 - * Load Current Clamp Sensor KEW 8121/8122/8123
 - * Voltage Sensor KEW 8309 (for KEW5020)
- TRMS measurement & recording of AC Current (50/60Hz) & AC Voltage (50/60Hz, only on KEW5020)
- LED to indicate pre-set current/ voltage value is exceeded. (Trigger/ Capture Recording, Power Quality Analysis modes)
- Can store 60,000 data when using 1ch, and when using all 3ch, can store 20,000 data at each channel. (Normal recording mode)
- Data will not be lost at battery replacement or at low battery voltage as it is stored in nonvolatile memory.
- Long time recording is available by a use of external AC Adaptor (optional parts) Installed batteries enables backup at a temporarily electricity failure. Size AA Alkaline Battery: about 10-day measurement.
- Can transfer the recorded data to PC via USB cable.
- Protected throughout by double (reinforced) insulation “□”
- This instrument provides 3 Recording modes and Power Quality Analysis mode (only KEW5020). Various insulation monitoring are available with 4 recording modes. Understand characteristic of each recording mode and select an appropriate mode.

3. Instrument layout

3-1) Panel

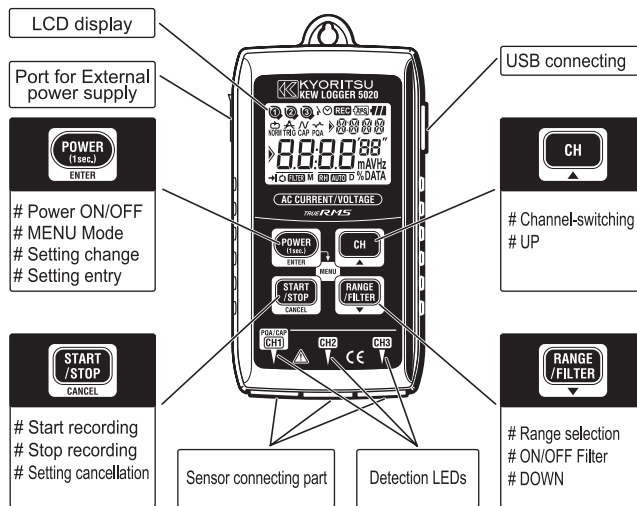

- ◆ Detection LEDs P.28
- ◆ USB P.43
- ◆ Port for External power supply P.46

3-2) LCD

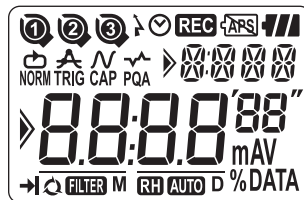

Mark	Details
① ② ③	Channel number (CH No.) : Selected Channel number is displayed. Memory Block Number : Memory block (No. 1 to 3) in use is indicated. (P. 38)
	Sensor Mark : Displayed on the CH No. to Indicate the connected Sensor.
	Clock Mark : Indicates time
	Timer Mark : Timer function is activated. (Stand-by till the preset time.)
REC	Recording Mark : Recording is being performed.
	Auto-power-off is disabled. (Instrument won't be off automatically.)
	Battery Mark : Indicates battery voltage in 4-level
	Recording mode
	Sub-indication : Indicates Menu items
M D	Date : Month, Day
	Main indication : Displays measured, preset and recording values
	Guide mark : Items can be switched with / button.
	One-time : Recording stops when memory becomes full
	Endless : Overwrite the old data, and store the latest data.
RH AUTO	Range Hold/ Auto Range mark : Status of the selected Range
FILTER	Filter mark : Indicates Filter function is activated.

3-3) Displayed message

Message	Meaning
NC	Sensor is not connected.
OL	Over-range
SET.1	Menu: Setting1 (SET.1) P.18 View or change the recording mode/ condition.
SET.2	Menu: Setting2 (SET.2) P.34 View or change the Location information and auto-power-off function.
CALL	Menu: Recall(CALL) P.39 Recorded qty., Max value reference, Recall
Nor	Normal recording mode
Tr	Trigger recording mode
CAP	Capture recording mode
PQA	Power Quality Analysis mode [KEW5020 only]
-PC-	PC data in transit
CLR	Warning of memory clear
Err	Error (improper Sensor is connected under Power Quality Analysis mode/ KEW5020 only) (P.47)
FULL	All the Memory block are occupied. (P.16) Move the data and clear the memory. (P.34)





Sub-indication	Sensor Type
LOAD	Load current clamp sensor
VOLT	Voltage Sensor
CURR	Leakage & Load current clamp sensor
LEAK	Leakage current clamp sensor

3-4) Function of Button





Power ON / OFF

Button	Power ON	Power OFF
	Pressing at least 1 sec (while the LOGGER is off)	Pressing at least 1 sec (except for recording status)

Recording/ Measurement mode

Button	Function
	Enter into Menu mode
	Start and stop recording
	Switch channels
	Switch Range and Filter (P.9)

Menu mode

Button	Menu	Setting Change (flashing)
	Select Menu	Setting change, Enter
	Back	Cancel
	Switch Menu item	Increase number
	Switch Menu item	Decrease number

3-5) Range/ Filter Function

- Range Configuration

Range configuration varies depending on each connected Sensor.
Refer to "12. Specification" (P.45) in this manual.

- Auto-ranging

Auto-ranging is available only in Normal Recording mode. It isn't available on a Sensor providing one single range.
(e.g. Voltage Sensor "KEW8309" for KEW5020)

- Range Hold

Select the ranges with **RH** mark to fix measurement range under Normal Recording mode.

Measurement range in Trigger/ Capture Recording mode is decided depending on a detection level. Switching of measurement ranges with the  button isn't possible.

- Filter Function

Lowpass Filter works when Filter Function is ON (**FILTER** mark lights up) and filter out the frequency in higher harmonics band.
(Cutoff Frequency: approx 160Hz, attenuation rate -24dB)

- Range/ Filter Function for each Recording mode

Recording mode	Function
Normal recording	* Switching ranges, On/Off Filter * Auto-ranging is available.
Trigger/ Capture recording	* On/Off Filter * Range corresponds to detection level * Auto-ranging isn't available.
Power Quality Analysis [KEW5020 only]	* On/Off Filter * Auto-ranging isn't available.

4. Recording procedures

Following explains the flow of operation: through preparation to the stop of recording.

P.11

Step1: Start-up



Select the appropriate sensor, and connect it to the instrument.

P.12

Step2: Confirmation of the set value



Confirm the recording mode.

P.13

Step3: Preparation before recording



Install the instrument and do setups for each channel.

P.15

Step4: Start of recording



Start recording.

P.17

Step5: Stop of recording

Stop recording.

* The recorded data can be viewed either by the following two methods.

- (1) On a PC: Follow the instruction described at "**10. Data transfer to PC**" in this manual (P.43) for data transfer, and Help for PC Software "KEW LOG Soft 2" for operation method.
- (2) On the instrument: Refer to Confirmation of recorded data (CALL) (P.39)

* Press the  button at least 1 sec. to power off the instrument.
(This is because to prevent operational error.)

Step1: Start-up

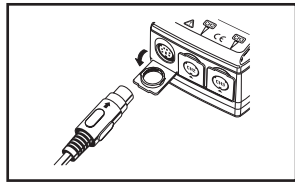

1. Press the **POWER (1sec.)** button and power off the instrument. Connect a Clamp/Voltage Sensor to CH1 (for multiple connection, starting from CH1) while the instrument is being off. Connect them firmly with careful attention to the orientation of the connector.

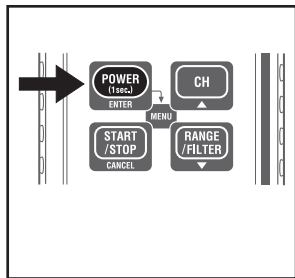

2. Press the **POWER (1sec.)** button at least 1 sec. to power on the instrument. Release the button when all indications are displayed on the LCD. First, time is displayed, and then sensors being connected are displayed. If incorrect time is displayed whenever powering on the instrument, internal battery for clock may be exhausted. In this case, send back the instrument to your local KEW distributor for repair.

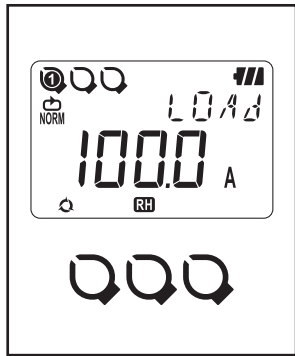

3. Check the connected Sensors. Sensor (P.7) and the full-scale value are displayed. (beginning from CH1)

- ◆ Sensor mark is displayed on the CH No., to which a Sensor is connected .
- ◆ Only CH1 is used in Capture REC mode.
- ◆ Voltage sensor is connected to CH1 in PQA REC mode (only on KEW5020).
- ◆ Voltage sensor cannot be used with KEW5010.
- ◆ Power off the instrument and repeat steps from 1. to re-connect a Sensor.

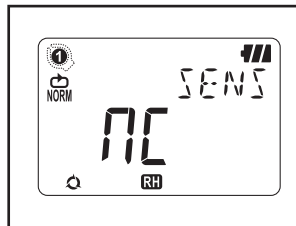





4. Can make measurement right after powering on the instrument.
 * Each time pressing the **CH** button, CH1 to CH3 switches. When **NC** (non-connect) is displayed on the LCD, a sensor is not connected to the selected channel; or the connection is incorrect.

Step2: Confirmation of preset value



Check the mark indicating the selected recording mode. Refer to “**5. Recording modes and conditions**” in this manual to change the recording mode or condition (Recording interval / Preset current)

Recording mode	Details	Refer to
Normal  NORM	Performs continuous measurement/recording at the pre-set intervals. (15-kind: 1 sec. to 60min.)	P.19
Trigger  TRIG	Records 8 data (0.8 sec.) in total with time information when pre-set detection level is exceeded.	P.22
Capture  CAP	Records 10 (50Hz) to 12 waveforms (60Hz) when preset detection level is exceeded. (Graph can be viewed on PC)	P.24 (PC setting)
Power Quality Analysis (only 5020)  PQA	Records date and time information when preset Swell, Dip and Short interruption value are exceeded.	P.24 (PC setting)

Step3: Preparation before recording

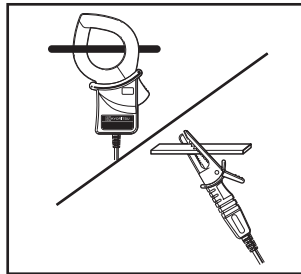

1. Clamp on the measured object and fix the Sensor. Firmly fix it so as not to easily come off.

Care should be taken, when connecting the Voltage Sensor designed only for KEW5020, not to short the object under test.

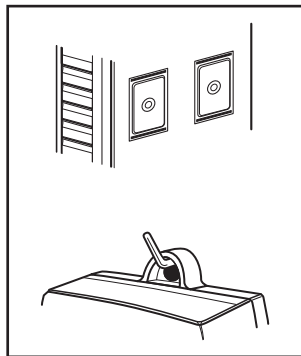

2. Fix the instrument.

- 1) Fix the instrument with magnet :

Can fix the instrument to metallic plate with the magnet on its backside.

- 2) Hang the instrument on hook :

Can fix the instrument with a hook or screw by using the hooking hole on the top of the instrument.

(Firmly fix it so as not to easily come off.)



3. Press the **CH** button to switch the display of measured value among CH1 to 3. Confirm a proper Sensor is connected to an appropriate CH.

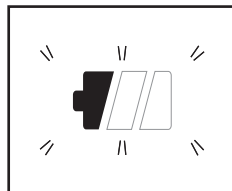
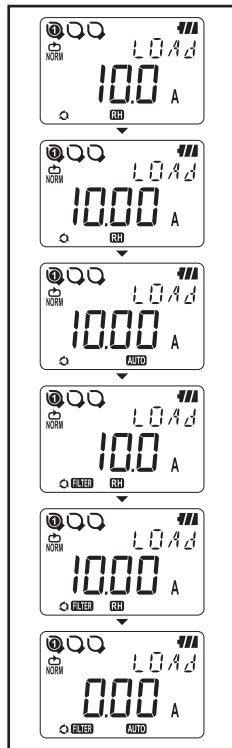

4. Check a Range/ Filter

Press the **CH** button to check their on/off status.

Press the **RANGE/FILTER** button to change them. Independent setting of Range & Filter is available on each CH.

Point

- At Normal Recording mode, Range and Filter switches each time pressing the **RANGE/FILTER** button.

Auto-ranging is also available.

- At Trigger/Capture/Power Quality Analysis modes, only Filter on/off is available. Range is selected automatically based on the detection level (preset value for Trigger/ Capture Recording). See Setting1 "Set.1".

- Setting change isn't available during recording; setting should be done prior to a recording.

RH mark means Range Hold Function is activated.

AUTO mark means Auto-ranging Function is activated.

5. When only the leftmost segment of the Battery mark is flashing on the LCD, it means battery voltage is low.

Replace the batteries with new ones. When nothing is displayed on the LCD, the batteries are exhausted. Replace the batteries with new ones.

Step3: Preparation before recording

* Settings cannot be changed during recording. Carefully check the settings prior to a recording.

* Previous recorded data is cleared and new recording starts when changing the followings and starts recording. (In this case, "CLR" flashes on the LCD at a start of recording.)

- 1) Recording mode is changed.
- 2) CH for Sensor is changed.
- 3) Sensor type is changed.

* Transfer important data to your PC first and clear Memory (P.33) since further recording isn't activated when all the 3 blocks in Memory Block (P.15) are full.

* Follow the procedure below to start recording.

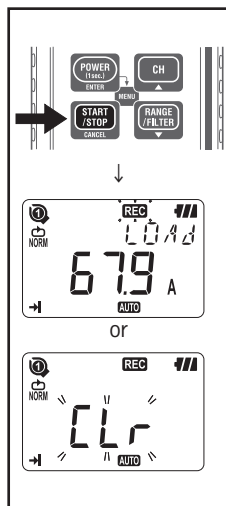

1. Press down the **START/STOP** button at least 4 sec. "REC" or "CLR" mark flashes. Keep the button pressed down until "REC" mark lights up. Recording stops when the button is released while the mark is flashing.
 2. Measured value is displayed and "REC" mark lights up, then measurement starts.
- ◆ Additional three recordings (Memory Block / see the next page) are possible. In this case, one-time is automatically selected and recording stops when memory becomes full.
 - ◆ It is recommended to clear the memory before starting to record if previous data is not necessary.

Memory Block

- ◆ One memory block is used from the start to the end of recording.
- ◆ 3 blocks in the Memory Block are available; it enables 3 different recordings at different locations.
- ◆ Transfer important data to your PC first and clear Memory (Setting 2 or via PC) since further recording isn't activated when all the 3 blocks in Memory Block are used.
- ◆ Settable Location No. at Setting 2 "SEt.2" is saved in the Memory Block together with the measured data; and is useful to recognize the location where the data recorded on your PC.
- ◆ At Trigger/ Capture/ Power Quality Analysis modes, zero is saved in Memory Block even when no data is recorded from the start to the end of recording.

Operation during recording

Following operations are available during recording.

- ◆ Displaying the measured value at each CH →  button
- ◆ Recording status : Displaying Max recorded valued & RECALL
Refer to **9. Confirmation of recorded data** in this manual.
- ◆ Check of preset values at Setting 1 "SEt.1" & Setting 2 "SEt.2".

Following operations aren't available during recording.

- ◆ Powering off the instrument
- ◆ Changing the measurement range.
- ◆ Change of preset values at Setting 1 "SEt.1" & Setting 2 "SEt.2".
- ◆ Data communication with PC

Stop recording to do above operations.

Step5: Stop of recording

In case that One-time is set to "ON" at Step2: Confirmation and change of preset value, recording is stopped automatically when Memory becomes full.

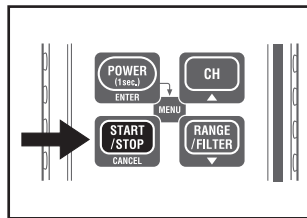

1. Press the **START/STOP** button at least 1 sec to stop recording.
2. Recording stops, and the "REC" mark disappears. Then the instrument goes back into measurement state.

Now, recording completes.

- * Press the **POWER (1sec.)** button at least 1 sec to power off the instrument.
- * It is recommended to transfer the important data to a PC.
- * The recorded data can be checked on the instrument.
(Refer to : **9. Confirmation of recorded data (CALL)** in this manual)

5. Recording modes and conditions

* Recording mode and condition can be set on the instrument ; but PC software "KEW LOG Soft 2" provides much easier setting.

* Only Normal and Trigger Recording modes can be set on the instrument. Capture recording and Power Quality Analysis modes need to be set via a PC. (Recording condition for the Capture Recording mode is changeable on the instrument.)

● Setting on the instrument (Menu Mode)

1. Power on the instrument, and press the











button

to enter into Menu Mode.

2. Select and set desirable recording mode and condition at "SEt.1 on the Menu. Setting with the instrument is mentioned on the next page.
3. Press the **ENTER** button at "End" on Menu Screen or press the **CANCEL** button and exit from the Menu Screen to return measurement status.

Each button acts as follows at Menu mode.

	→		: Select, Change, Enter
	→		: Return, Cancel
	→		: Switch, Increase values
	→		: Switch, Decrease values

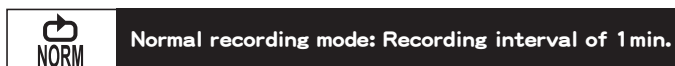

Max. number of recorded data

Using all 3 channels	Using 2 channels	Using only 1 channel
20,000 data	30,000 data	60,000 data

Max. recording duration

Recording interval	Using all 3 channels	Using 2 channels	Using only 1 channel
1 sec.	5:33:20	8:20:00	16:40:00
2 sec.	11:06:40	16:40:00	1 day / 9:20:00
5 sec.	1 day / 3:46:40	1 day /17:40:00	3 days/11:20:00
10 sec.	2 days/ 7:33:20	3 days/11:20:00	6 days/22:40:00
15 sec.	3 days/11:20:00	5 days/ 5:00:00	10 days/10:00:00
20 sec.	4 days/15:06:40	6 days/22:40:00	13 days/21:20:00
30 sec.	6 days/22:40:00	10 days/10:00:00	20 days/20:00:00
1 min.	13 days/21:20:00	20 days/20:00:00	41 days/16:00:00
2 min.	27 days/18:40:00	41 days/16:00:00	83 days/ 8:00:00
5 min.	69 days/10:40:00	104 days/ 4:00:00	208 days/ 8:00:00
10 min.	138 days/21:20:00	208 days/ 8:00:00	416 days/16:00:00
15 min.	208 days/ 8:00:00	260 days/10:00:00	520 days/ 0:00:00
20 min.	277 days/18:40:00	416 days/16:00:00	833 days/ 8:00:00
30 min.	416 days/16:00:00	625 days/ 0:00:00	1250 days/ 0:00:00
60 min.	833 days/ 8:00:00	1250 days/ 8:00:00	2500 days/ 0:00:00

* Max recording time is dependent on battery life (approx 10-day with size AA Alkaline battery) Use of optional AC Adopter is recommended for long time recording.

Setting items

Item	Range for Setting	Default
Recording interval	1,2,5,10,15,20,30 sec, 1,2,5,10,15,20,30,60min	1 min
One-time/ Endless	One-time/ Endless	Endless

Setting procedure

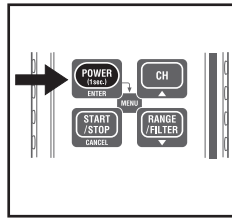



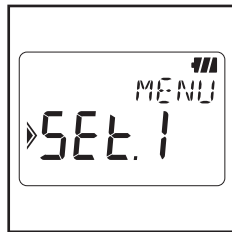



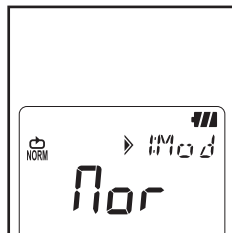



1. Power on the instrument, and press the  button. Then the instrument enters into Menu mode.



2. Press the  button when "SET.1" is displayed on the LCD.





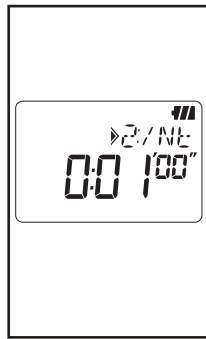

3. Selected recording mode is displayed.
 - ◆When  (Normal recording mode) is displayed on the LCD, press the  button to proceed to the next setting.
 - ◆In case that ,  or  is displayed on the LCD, press the  button. Then the indication on the LCD flashes. Press the  or  button to change it to . Press the  button.



4. Then recording interval is displayed.



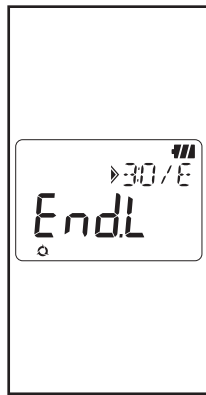

Can be selected from; 1, 2, 5, 10, 15, 20, 30 sec.,
1, 2, 5, 10, 15, 20, 30, 60 min

- ◆ Press the  button and proceed to the next step when not changing the setting.
- ◆ To change the setting, press the  button. Then the indication on the LCD flashes.
Press the  or  button to set the value to the desired one. Then press the  button to confirm it.



5. Next, One-time/ Endless is indicated.

- ➔ One-time: Recording stops when memory becomes full.
- 🔄 Endless : Overwrite the old data, and store the latest data.

- ◆ Press the  button and proceed to the next step when not changing the setting.
- ◆ To change the setting, press the  button. Then the indication on the LCD flashes.
Press the  or  button to set the value to the desired one. Then press the  button to confirm it.

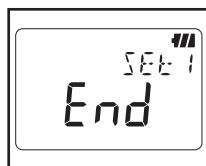

6. Now Setting 1 is complete; "End" is displayed on the LCD. Press the  button to return to the screen on which "SET.1" is displayed.

7. Press the  button to get the instrument ready for a measurement.



Trigger recording mode: Current set value of 15A

Max. number of recorded data

Using all 3 channels	Using 2 channels	Using only 1 channel
1,600 data	2,400 data	4,800 data

Setting items

Item	Range for Setting	Default
CH1 Detection Level	0 ~ 1000 (Unit depends on Sensor)	15
CH2 Detection Level	0 ~ 1000 (Unit depends on Sensor)	15
CH3 Detection Level	0 ~ 1000 (Unit depends on Sensor)	15
One-time/ Endless	One-time/ Endless	Endless

Setting procedure

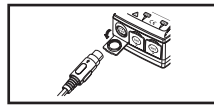

1. Connect a Sensor first prior to do setting.
When Sensor is not connected to the instrument at setting, connect a Sensor, and then power off once and on the instrument.



2. Press the button while instrument is on to enter into Menu mode.
3. Press the button when "SET.1" is displayed on the LCD.

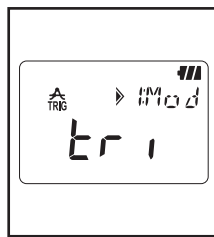

4. The selected recording mode is displayed.
 - ◆When (Trigger recording mode) is displayed on the LCD, press the button to proceed to the next setting.
 - ◆In case that , or is displayed on the LCD, press the button. Then the indication on the LCD flashes. Press the or button to change it to . Press the button.

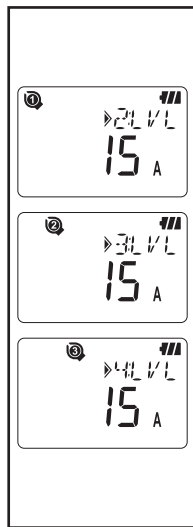

5. Detection level at CH1 is indicated.

Can be set at every 1 from 0 to 1000

- ◆ To change the setting, press the **ENTER** button. Then the indication on the LCD flashes.
- ◆ Press the **▲** or **▼** button to set the value to the desired one. Then press the **ENTER** button to confirm it.
- ◆ When using Leakage Current Sensor, pressing the **▲** button at 1000mA indication changes to 2A, pressing the **▼** button at 2A indication changes to 1000mA (1A)

Point

Further detection doesn't start when a value falls to 50% or less (for voltage sensor: 1% or more) of the detected level. Set the appropriate value based on the test prior to recording.

6. Confirm or change the preset current value on channel 2 and 3 as well.

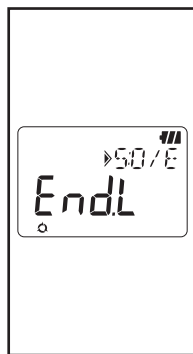

7. Next, One-time/ Endless is indicated.

- ➔ One-time: Recording stops when memory becomes full.
- 🔄 Endless : Overwrite the old data, and store the latest data.

- ◆ Press the **▼** button and proceed to the next step when not changing the setting.
- ◆ To change the setting, press the **ENTER** button. Then the indication on the LCD flashes. Press the **▲** or **▼** button to set the value to the desired one. Then press the **ENTER** button to confirm it.

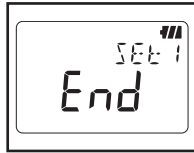

8. Now Setting 1 is completed; "End" is displayed on the LCD. Press the **ENTER** button to return to the screen on which "SEt.1" is displayed.
9. Press the **CANCEL** button to get the instrument ready for a measurement.

CAP Capture recording mode: (Setting on PC)

* Setting is available only on PC.

Max number of recorded data

Using only 1 channel
345 data

Setting item

Item	Range for Setting	Default
CH1 Detection Level	0 ~ 1000	15
One-time/ Endless	One-time/ Endless	Endless

PQA Power Quality Analysis [only 5020] (Setting on PC)

* Setting is available only on PC.

Max number of recorded data





Using only 1 channel
4000 data

Setting item

Item	Range for Setting	Default
Reference Voltage (System Supply Voltage)	100V ~500V	100V
Swell Detection (Ratio against Reference Voltage)	100% ~200%	110% (110V)
Dip Detection (Ratio against Reference Voltage)	0% ~100%	90% (90V)
Short Interruption Detection (Ratio against Reference Voltage)	0% ~100%	10% (10V)
Hysteresis (Ratio against Reference Voltage)	0% ~10%	1% (1V)
One-time/ Endless	One-time/ Endless	Endless

6. Recording modes

List of recording modes

Recording mode	Normal Recording	Trigger Recording	Capture recording	Power Quality Analysis
	 NORM	 TRIG	 CAP	 PQA
Details	P.26	P.27	P.29	P.30
Application	Status/ Simplified power monitor	Detection of abnormal current/ voltage	Check of waveform	Detection of abnormal voltage variation(only 50/20)
Can record:	60,000 data (1ch) 20,000 data (3ch)	4,800 data (1ch) 1,600 data (3ch)	345 data	4,000 data
Available CH	3 channels at the same time		1 channel only	
Recording Interval	15-kind: 1 sec. to 60 min.	—		
Detection Level	—	0 ~ 1000 (Unit depends on Sensor)		
RMS measuring interval	Approx. at every 0.1 sec.			
Sampling Cycle	Approx. 1.65mS/CH		Detection: Approx. 0.55mS/ WaveformApprox. 1.1mS	Approx. 0.55mS
Sampling Period	Always	Constantly until current detection		Always
Record timing	At every interval	When the preset detection value is exceeded.(irregular)		
Measuring method	True RMS	Detection: Average value/ (convert the Peak value (sine) to RMS) Recording, Indication: True RMS		
One-time system	One-time: Recording stops when memory becomes full. Endless: Overwrite the old data, and store the latest data.			
Battery Life	Approx. 10days			

1. Normal Recording mode

- Sampling period and RMS calculation

Sampling the inputs at every 1.6ms/CH and calculate the measured value (RMS) at every 100ms. The Peak value (crest value in sampling data) will be updated and kept.

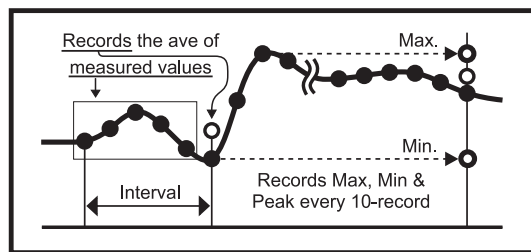

- Recording

Average of the measured value is recorded at every recording interval. RMS measured values, Max, Min and Peak values (sampled crest value converted to sine RMS value) are recorded at every 10 times of recording.

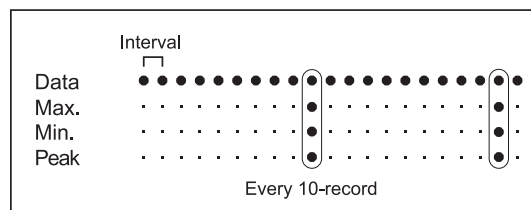

- Display of measured value

Average of RMS value is displayed on the LCD at every 1 sec. (10 data)

2. Trigger Recording mode

● Detection and RMS value calculation

Sampling the inputs at every 1.6ms and comparing the Peak value (sampled crest value converted to sine RMS value) and Detection level. For current, when the Peak value exceeds the level and for voltage when the Peak value is below the level; detection is triggered. RMS value is calculated at every 100ms.

● Recording

When the Detection level is exceeded, 8 data (for about 0.8 sec) Including:

- 3 RMS values prior to the cross over point
- RMS value at the cross over point
- 4 RMS values subsequent to the cross over point

are recorded with time information. In case that events exceeding the Detection level occur continuously, next detection doesn't start until it drops to 50% or less of the detected value.

(for voltage, 5% or more than the detected value)

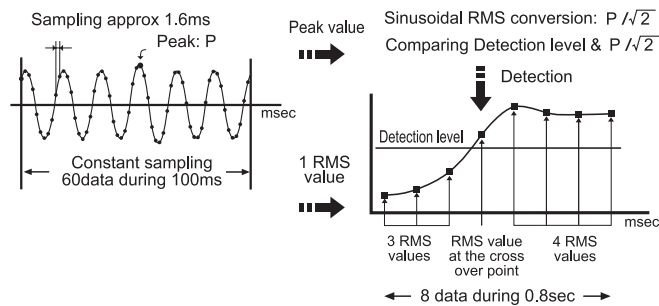

● Display of measured value

Average of RMS value is displayed on the LCD at every 1 sec.
(10 data)

◆Flashing Detection LED

- LED on the Sensor connected channel blinks when following Trigger is detected.

<On KEW5010> Trigger is detected when the measured values exceed the pre-set detection level under Trigger/ Capture Recording Mode.

<On KEW5020> Trigger is detected when the measured current values exceed the pre-set detection level under Trigger/ Capture Recording Mode and Power Quality Analysis Mode.

For voltage values, Trigger is detected when it is below the detection level.

- LED flashes whenever the measured values exceed the pre-set detection level during measurements.
- LED blinks every 4 sec during recordings after one detection occurs. (When Auto-power off is OFF, it blinks every 2 sec.)
- To restore the blinking LED during recordings, first press the  button once and enters into Menu mode. Then press the **CANCEL** button to return Measurement mode.

3. Capture Recording mode

●Detection and RMS value calculation

Sampling the inputs at every 0.55ms only at CH1 and comparing the Peak value (sampled crest value converted to sine RMS value) and Detection level. For current, when the Peak value exceeds the level and for voltage when the Peak value is below the level; detection is triggered. RMS value is calculated at every 100ms.

●Recording

When the preset current value is exceeded, instantaneous values with corresponding time information are recorded for 200ms (10 or 12 waveforms) including 50ms prior to and subsequent to the cross over point. In case that events exceeding the Detection level occur continuously, next detection doesn't start until it drops to 50% or less of the detected value. (for voltage, 5% or more than the detected value)

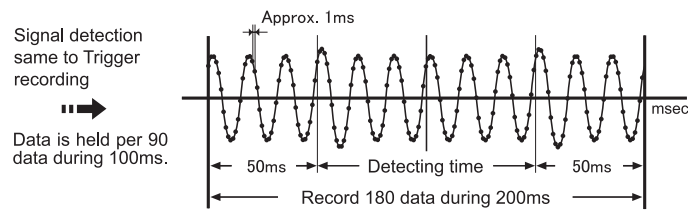

●Display of measured value

Average of RMS value is displayed on the LCD at every 1 sec.

(10 data)

(Waveform display is only available on PC. Use the enclosed Software and transfer the data to your PC.)

4. Power Quality Analysis Mode (only 5020)

- Detection and RMS value calculation

Sampling the inputs at every 0.55ms only at CH1 and comparing the Peak value (sampled crest value converted to sine RMS value) at every 10ms and preset value to detect swell, dip and short interruption in power supply. RMS value is calculated at every 100ms.

- Recording

When swell, dip or short interruption is detected, the detected value is recorded as Start (S) with time and date information.

In case that a input becomes close to the reference voltage by hysteresis value, it is recorded as End (E) with time and date information.

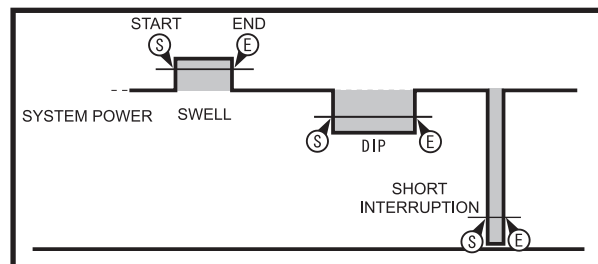

- Display of measured value

Average of RMS value is displayed on the LCD at every 1 sec.
(10 data)

7 . Simplified Power Integration (available via KEW LOG Soft 2)

The PC software "KEW LOG Soft 2" provides easy calculation of integral power consumption by use of current and voltage (only on KEW5020) recorded under **Normal Recording mode**.

- On KEW 5010, measures and records current values, and then enter any voltage value and power factor on "KEW LOG Soft 2" to calculate simplified power consumption.
- On KEW 5020, simplified power calculation is available by using Voltage and Current Sensors; apply any power factor to the recorded voltage and current values via "KEW LOG Soft 2".
Calculation with any voltage value as same as KEW5010 is also possible.

Example of Connection

- ◆ Single-phase 2-wire (1 Φ 2W)

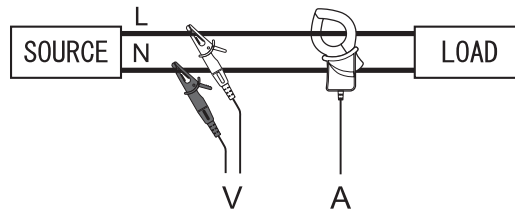

Model Name	CH1	CH2	CH3	KEW LOG Soft2 Fixed parameters
KEW 5010	A	---	---	Voltage value, Power factor
KEW 5020	A	---	---	Voltage value, Power factor
	V	A	---	Power factor

* Can be connected with 3 systems via each channel (1 through 3).

◆ Single-phase 3-wire (1 Φ 3W)

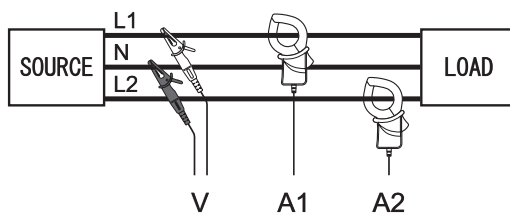

Model Name	CH1	CH2	CH3	KEW LOG Soft2 Fixed parameters
KEW 5010	A1	A2	---	Voltage value, Power factor
KEW 5020	A1	A2	---	Voltage value, Power factor
	V	A1	A2	Power factor

◆ Three-phase 3-wire (3 Φ 3W)

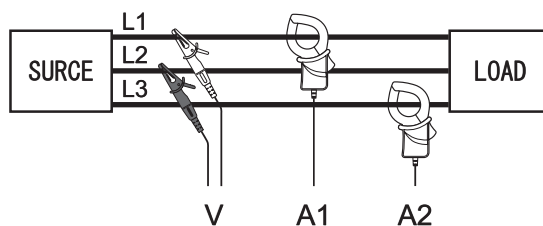

General formula is: $P = V \times (A1 \times \cos(30^\circ - \Phi 1) + A2 \times \cos(30^\circ + \Phi 2))$,
however, here $\Phi 1 = \Phi 2$ is applied.

Therefore: $P = \sqrt{3}/2 \times V \times (A1 + A2) \times PF$

Model Name	CH1	CH2	CH3	KEW LOG Soft2 Fixed parameters
KEW 5010	A1	A2	---	Voltage value, Power factor
KEW 5020	A1	A2	---	Voltage value, Power factor
	V	A1	A2	Power factor

◆ Three-phase 4-wire (3Φ4W)

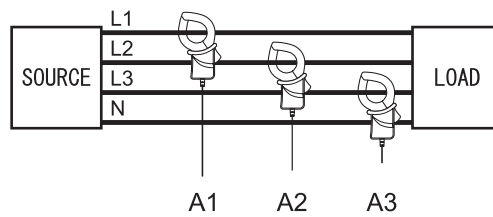

Model Name	CH1	CH2	CH3	KEW LOG Soft2 Fixed parameters
KEW 5010	A1	A2	A3	Voltage value, Power factor
KEW 5020	A1	A2	A3	Voltage value, Power factor





* Refer to "KEW LOG Soft 2- HELP" how to operate KEW LOG Soft 2.

The latest "KEW LOG Soft 2" can be downloaded from our web site.
<http://www.kew-ltd.co.jp>









8. Other settings (Setting2)

- Recording mode and condition can be set on the instrument; but PC software "KEW LOG Soft 2" provides much easier setting.
- Time setting for Year, Month, Day, Hour, Minute and Second is available on PC, but setting for Hour and Minute only are available on the instrument.

Menu Setting 2: "SEt.2" Setting items

- 1) Location information [Default:000]
Set the location no. to identify the measuring and recording place.
- 2) Auto-power-off  [Default:000]
Enable/ Disable the Auto-power-off function.
- 3) Time 
Capable of adjusting the time between 00:00 and 23:59.
- 4) Timer   [Default:OFF]
Display and set the timer.
- 5) Memory Clear
Clear all the recorded data.

Each button acts as follows at Menu mode.

- | | | | |
|---|---|---|---------------------------|
|  | → |  | : Select, Change, Enter |
|  | → |  | : Return, Cancel |
|  | → |  | : Switch, Increase values |
|  | → |  | : Switch, Decrease values |

Setting procedure

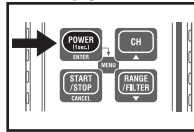

1. Power on the instrument, and press the  button.



2. Press the  button when "SEt.1" is displayed on the LCD.



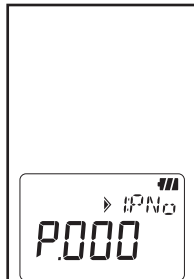

3. Press the  button when "SEt.2" is displayed on the LCD.







4. "Location information":

Location No. is displayed on the LCD.

 Can be selected between "P.000" and "P.999".

◆ Press the  button and proceed to the next step (Auto-power-off) when not changing the setting.

◆ To change the setting, press the  button.

Then the indication on the LCD flashes. Press the  or  button to set the value to the desired one. Then press the  button to confirm it.

Point

- Preset Location No. is saved with a recorded data (1 Memory Block). When performing



additional recordings (up to 3 Memory Blocks), it is recommended to set each Location No. in advance. It is useful to identify the recorded locations per Memory Block.

- Location No. is linked to the Location list and allows to display the Location name, which corresponding to the Location No., when displaying data on PC Software.
- In case of setting Location no. on the instrument, it is recommended to take notes of the Location No. and the name.

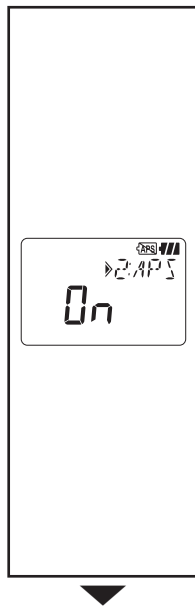





5. "Auto-power-off":

State of Auto-power-off function is displayed.

On : Enables Auto-power-off function.

OFF : Disables Auto-power-off function.

◆ Press the  button and proceed to the next step (Time) when not changing the setting.

◆ To change the setting, press the  button. Then the indication on the LCD flashes. Press the  or  button to set the value to the desired one. Then press the  button to confirm it.

Point

" AFS" mark appears on the LCD when this Function is "OFF". Power off the instrument after use. Instrument powers off about 3 min after the last Key operation when the Function is "ON". LCD indication disappears during recording due to Power Save Function while recording is being performed.

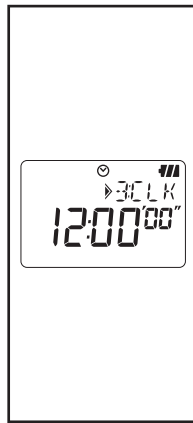



6. "Time": Time is displayed.

Can be adjusted between "00:00" and "23:59".

◆ Press the  button and proceed to the next step (Timer) when not changing the setting.

◆ To change the setting, press the  button. Then the indication on the LCD flashes.

Press the  or  button to set the value to the desired one. Then press the  button to confirm it.

Point

Connect the instrument to PC and set time and date via PC software : "KEW LOG Soft 2".

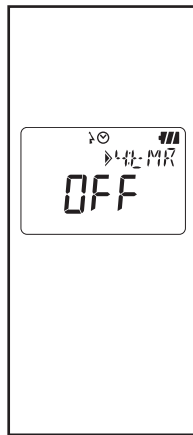



7. "Timer": State of Timer function is displayed.

Can be set between "00:00" and "23:59".

◆ Press the  button and proceed to the next step (Memory Clear) when not changing the setting.

◆ To change the setting, press the  button. Then the indication on the LCD flashes.

Press the  or  button to set the value to the desired one. Then press the  button to confirm it.

Point

Press the  button at least 1 sec.

after setting Timer. Then the instrument goes into stand-by mode for recording.

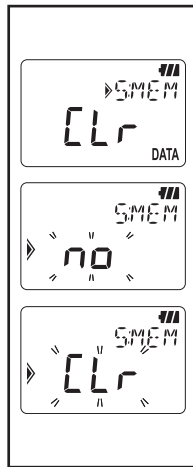

Recording starts at the preset time.



8. "Memory Clear": Clear the recorded data.

◆ Press the  button to end Setting 2 when you don't clear the Memory.

◆ Pressing the  button flashes the indication on the LCD.

Recorded data isn't deleted by pressing the  button, while "no" is displayed on the LCD. Press the  button to change the indication to "CLr", and then press the  button to clear the recorded data. Message "O DATA" is indicated and back to "CLr" indication when data is cleared.



9. Now Setting 2 is completed; "End" is displayed on the LCD. Press the  button to return the screen on which "SEt.2" is displayed.

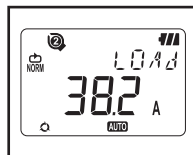









10. Press the  button to get the instrument ready for a measurement.

9. Confirmation of recorded data (CALL)

Details of data in the present Memory Block can be viewed during recording and when recording is completed.

- ◆ Display of percentage of recorded data against memory capacity.
- ◆ Capable of checking max, min, instant Peak/ Detection value at each channel with time & date information.
- ◆ RECALL: can check the latest 10 data with time and date information.

Each button acts as follows at Menu mode.

	→		: Select, Change, Enter
	→		: Return, Cancel
	→		: Switch, Increase values
	→		: Switch, Decrease values

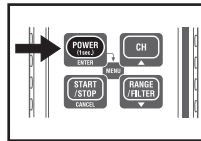

1. Pressing the  Button during recording enters into Menu mode.

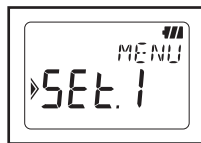

2. Press the  Button twice while "SEt.1" is displayed on the LCD.

* "CALL" is displayed on the LCD while recording is being performed. Proceed to the next.

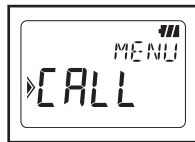

3. Press the **ENTER** Button while "CALL" is displayed on the LCD.

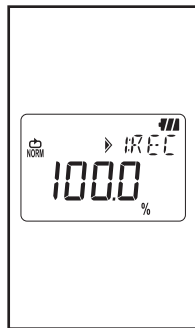

4. Check of <Recorded qty.>
Percentage of recorded data against memory capacity is displayed.

* Memory block with recorded data is indicated by the Marks: ①②③. When all 3 marks are lit up, all the Memory blocks are used. Transfer the important data to a PC and clear the Memory to perform next recording.

Pressing the  Button proceeds to the next.

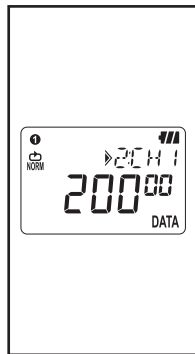

5. Display of the number of the recorded data at CH1/ the number of detected current & voltage data in case of Trigger Recording mode.

◆ Pressing  Button moves to CH2.

◆ Press the **ENTER** Button to check max, min and peak values on CH1 with time and date information. See P.42 <<MAX, MIN, Instant PEAK/ detected value>>.

◆ Press the  Button until the indication becomes "5:RCL" for RECALL and proceed to step 8.

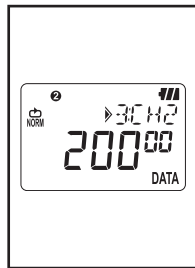

6. Display of the number of the recorded data at CH2/ the number of detected current & voltage data in case of Trigger Recording mode.

Pressing the  Button moves to CH3.

◆ Press the  Button to check max, min and peak values with time and date information. See P.42 <<MAX, MIN, Instant PEAK/ detected value>>.

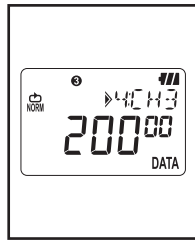

7. Display of the number of the recorded data at CH3/ the number of detected current & voltage data in case of Trigger Recording Mode.

Pressing the  Button moves to "RECALL".

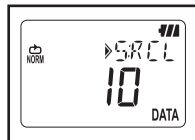

◆ Press the  Button to check max, min and peak values with time and date information. See P.42 <<MAX, MIN, Instant PEAK/ detected value>>.



8. <RECALL> checks the latest 10 recorded data.

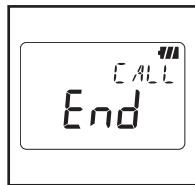

Press the  Button to check the latest recorded data and preceding 9 data, [R01] to [R10]. Refer to P.42 <<RECALL>>



9. That's all for CALL Function to call the recorded data. Pressing the  Button returns to the window with "CALL" message; pressing the  Button closes Menu mode and gets ready for measurement.

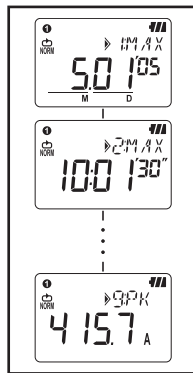

<<Reference of MAX, MIN, Instant PEAK/ Detected value>>

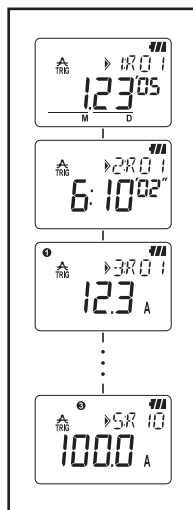

- * Pressing the  Button changes the information about the selected channel in following sequence.
MAX[Mon.Day'Year]→[Time:Min'Sec"]→[Max]→MIN
[Mon.Day'Year]→[Time:Min'Sec"]→[Min]→
Instant Peak/Detected value[Mon.Day'Year]→
[Time:Min'Sec"]→[Instant Peak/Detected value]
- ◆Indication of [- - -] stands for no data at the selected channel.
- ◆Pressing the  Button returns to the window with "Number of data".

<<Reference of RECALL>>



- * Pressing the  Button can check [Mon.Day'Year] → [Time:Min'Sec"] → [CH1 Data] → [CH2 Data] → [CH3 Data] from R01 to the latter data. Pressing the  Button after displaying [CH3 Data] displays data in [R02]. Repeat this step to check the latest data [R10].
- ◆Indication of [- - -] stands for no data at the selected channel.
- ◆Pressing the  Button returns to the window with [CALL].

10. Data transfer to PC

- Install PC software "KEW LOG Soft 2" on your PC to enable data communication between the instrument and your PC. Refer to the HELP contained in "KEW LOG Soft 2" which shows how to install the software. It will be on the Desktop after installing the software, or found in the folder of "KEW" from "Start" → "Program".
- When connecting the logger to PC for the first time, your PC will recognize this new hardware and install the USB driver. Follow the instructions described in the instruction manual for "KEW LOG Soft 2" and install it on your PC.

10-1 Connection of USB cable

- (1) Connect the USB cable to the available USB port of PC.

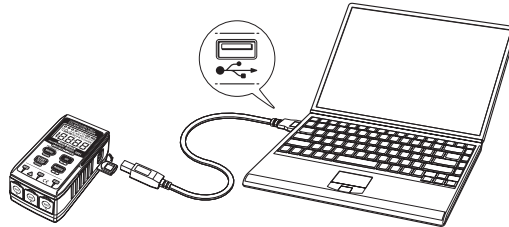

- (2) Connect the other end of USB cable to the USB terminal on the right side of this instrument.

Note:
Remove the protective cover of USB terminal carefully, and connect a cable to it. When the cover is damaged, it may cause poor contact due to dust, etc.

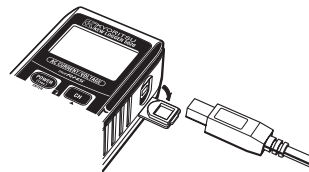

10-2 Preparation for data transmission

(1) Power on the instrument, and get the instrument ready for a measurement.

(Note: Data cannot be transferred while the instrument is performing a recording.)

(2) Start up the PC software: KEW LOG Soft 2.

10-3 Operation of PC software

Refer to the supplied instruction manual for "KEW LOG Soft 2" or "Help" and transfer the data to your PC. The PC may not detect the connected Logger or error message is displayed during data transfer, even if the PC and the Logger are connected correctly because of static electricity.

In this case, a message is displayed on the PC screen. Disconnect/connect the USB cable once accordingly, and transfer the data again.

10-4 Multiple connections

By using commercially available USB hub, multiple Loggers can be connected to your PC.

◆With PC software "KEW LOG Soft 2", the data can be transferred to PC by selecting one Logger from the list of detected Logger. You do not have to connect and disconnect a USB cable one by one.

◆Synchronization via [KEW LOG Soft 2] enables synchronized time setting on multiple LOGGERS at once.



11. Battery replacement

⚠ WARNING

- In order to avoid electrical shock, remove sensors from the instrument when replacing batteries.

⚠ CAUTION

- Do not mix new and old batteries.
- Install batteries in the orientation as shown inside the battery compartment, observing correct polarity.

When only the leftmost segment of the Battery mark  is flashing on the LCD, it means battery voltage is low. Replace the batteries with new ones. There is no influence on the measurement accuracy even if this warning mark is flashing. Nothing even the Battery mark  is displayed on the LCD if the batteries are completely exhausted. Replace the batteries with new ones.

(1) Loosen two Battery-cover -fixing screws on the backside of the instrument and remove the cover.

(2) Replace the batteries with new ones.

(Battery : Alkaline, LR6, 1.5V)

(3) Install the Battery cover, and tighten up the screws.

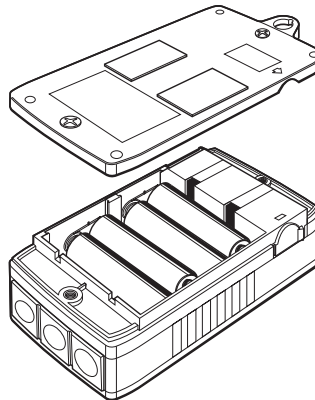

12. Auto-power off Function & External Power Supply

1) Auto-power off Function

LOGGER is automatically powered off in about 3 min after the last key operation while Auto-power off Function is "ON" at Setting 2. This function doesn't work during recording (LCD with **REC** mark) although readings aren't displayed on the LCD due to Power-saving Function.

In case of using an external power supply for making measurement, disable the Auto-power off Function. Then long period measurement is possible. (Be sure to power off the LOGEER after use.)

2) External power supply AC Adopter (optional)

WARNING

- Use MODEL 8320 (S-8458 or TAS2903 AC Adopter made by KAGA COMPONENTS co) only.
- Use the Power cord supplied with the AC Adopter.
- Confirm the voltage of power supply and the rated voltage of the AC Adopter, and then connect the Power Cord.
- Disconnect the Power cord of the AC Adopter from the outlet when the LOGGER isn't used for a long period.
- Do not put any heating object or others on the AC Adopter or Power Cord.
- Hold the Plug part (other than cord) when disconnecting the Power Cord from the outlet in order to prevent a break in the cord.

Specification of AC Adopter

- Rated supply voltage, Frequency : AC100V / 240V,50/60Hz
- Supply voltage, Range of Frequency variation : 90~264VAC,45~66Hz
- Rated output voltage of AC Adopter : DC9.0V
- Rated max Output current of AC Adopter : 1.4A

Use the optional AC Adopter for long period recordings. Installing batteries in the Case located at the backside of the unit provides power at temporary electricity failure. Be sure to check the battery level in advance.

Battery mark with full level will be displayed while using the AC Adaptor. Disconnect the Adaptor to check the battery voltage level.

13. Troubleshooting

When defect or breakdown of the instrument is suspected, check the following points first. If your problem isn't listed in this section, contact your local Kyoritsu distributor.

Symptom / Check
1. Unable to measure. (\overline{Fl}) is displayed.) <ul style="list-style-type: none">● Check if a sensor is connected to the properly.● Insert the sensor into the connector terminal firmly.● KEW 5010 doesn't recognize the voltage Sensor
2. Unable to measure. (\overline{Err}) is displayed.) <ul style="list-style-type: none">● Sensor other than Voltage Sensor may be connected to CH1 under the setting for Power Quality Analysis mode for KEW 5020.● Only the Voltage Sensor can be used under Power Quality Analysis mode.
3. Inaccurate readings <ul style="list-style-type: none">● Check if a clamp sensor is connected properly. Insert the sensor into the connector terminal firmly.● Check if the jaws are closed properly.● Check if an object stick to the jaw tips.
4. Nothing is displayed in the LCD
5. Battery symbol is blinked in the LCD.
6. The readings fluctuate. <ul style="list-style-type: none">● Check the battery voltage.● If the voltage is low, replace the batteries.

7. When the logger is connected to the PC using the USB cable, the logger connected is not detected in the logger list.
- Check if the USB cable is connected correctly.
 - Check if the USB driver is installed.
 - Check if the USB driver is failed to be installed on the PC.
 - If the installation is failed, firstly delete the USB driver installed and re-install it according to the procedure stated in the USB Notice sheet or Install Manual.
8. When installing the USB driver with the hardware Windows XP, the following remark appears.
- "The software you are installing for this hardware:
KEW LOGGER 5010/5020 has not passed Windows Logo testing to verify its compatibility with Windows XP."
Click "Continue Anyway" to continue the installation.
As operation check was done, no problem shall happen.

(Windows® is a registered trademark of Microsoft of the United States.)

14. Specification

Measuring Range and Accuracy

<RMS accuracy>

(AC 50/60Hz, Sine wave, Input: 10% or more of the range at CH1)

Range	KEW 8146 (30A) :100.0mA/1000mA/10.00A/30.0A KEW 8147 (70A) :100.0mA/1000mA/10.00A/70.0A KEW 8148 (100A) :100.0mA/1000mA/10.00A/100.0A KEW 8121 (100A) :10.00/100.0A KEW 8122 (500A) :50.00/500.0A KEW 8123 (1000A) :100.0/1000A KEW 8309 (600V) :600.0V (only 5020)
Digit number	4-digit
Effective Input Range	0% ~ 100% of each Range
Display Range	0% ~ 105% of each Range ("OL" is displayed over 105%.)
Accuracy	100.0mA Range: $\pm 2.0\%rdg \pm 0.9\%f.s.$ + Accuracy of Sensor Other ranges : $\pm 1.5\%rdg \pm 0.7\%f.s.$ + Accuracy of Sensor
Crest Factor	2.5 or less :RMS accuracy (sine) + $2\%rdg + 1\%f.s.$ (95% or less of each Range)

<Accuracy at Trigger Recording Mode (AC 50/60Hz sine wave)>

Accuracy	100.0mA Range: $\pm 3.5\%rdg \pm 2.2\%f.s.$ + Accuracy of Sensor Other ranges : $\pm 3.0\%rdg \pm 2.0\%f.s.$ + Accuracy of Sensor
----------	--

<Accuracy at Capture/ Power Quality Analysis mode>

<Accuracy of instantaneous value at Capture Recording mode>

Accuracy	100.0mA Range: $\pm 3.0\%rdg \pm 1.7\%f.s.$ + Accuracy of Sensor Other ranges : $\pm 2.5\%rdg \pm 1.5\%f.s.$ + Accuracy of Sensor
----------	--

NOTE:

- Refer to the Instruction Manual attached to the Sensor for the specification of each Sensor.
- Electromagnetic compatibility(EMC)
EN61000-4-2 Electrostatic discharge immunity(ESD) / Performance criteria: B
- Max, Min and Instant Peak values in Normal Recording mode are just reference values; their accuracies aren't guaranteed.

- Operating system : Successive Approximation
(CH1 single synchronized sampling)
- Rated max. working voltage : AC9.9Vrms, 14V peak value
- Number of input channel : 3ch
- Measuring method : True RMS
- RMS measuring interval : approx. 100ms.
- Sampling interval
 - Normal/Trigger mode : approx. 1.65ms/CH
 - Capture mode : approx. 0.55ms (waveform: at every 1.1ms)
 - P.Q.A mode : approx. 0.55ms
- Display : Liquid crystal display
- Low battery warning : Battery mark display (in 4 levels)
- Over-range indication : "OL" mark is displayed when exceeding the measuring range.
- Auto power off : Power-off function operates automatically after a switch remains for 3min. (when recording is stopped)
- Location for use : Indoor use, Altitude up to 2000m
- Temperature & humidity range(guaranteed accuracy):
23°C ±5°C / Relative humidity 85% or less (no condensation)
- Operating temperature & humidity range:
-10°C ~50°C / Relative humidity 85% or less (no condensation)
- Storage temperature & humidity range:
-20°C ~60°C / Relative humidity 85% or less (no condensation)
- Battery : DC6V: Alkaline battery(LR6) x 4pcs
External supply DC9V (Special AC Adapter)
- Current consumption : approx. 10mA
- Possible measurement time : Approx.10days (with alkaline LR6 batteries)
- Applicable standards : IEC 61010-1:2001 CATIII 300V Pollution degree2
IEC 61326 (EMC standard)
- Overload protection : 120%MAX/ 10sec of rated current/ voltage of each Sensor
- Withstand voltage : AC3540V (RMS 50/60Hz)/ for 5sec.
- Insulation resistance : 50Mohm or more / 1000V

- Dimension : 111(H) x 60(W) x 42(D)mm
- Weight : Approx.265g
- Accessories : Alkaline battery LR6 x 4pcs
PC software "KEW LOG Soft 2" : 1pce
USB cable: 1pce., Carrying case
Instruction manual, Quick manual
Install manual, USB Notice sheet
- Option : Leakage & Load current Clamp Sensor (KEW 8146/8147/8148)
Load current Sensor (KEW 8121/8122/8123)
Voltage Sensor (KEW 8309) [only KEW5020]
AC Adapter (M- 8320)
Carrying Bug (M-9135)
Extension cord for sensor (M-7185)