

E30 Series

Branch Circuit Power Meter

Product Overview

The E30 Series Branch Circuit Power Meter is a device designed to measure the current, and on some models, the voltage and energy consumption of up to 92 circuits (84 branch circuits, 2 3-phase mains, 2 neutrals) on a single board.

The E30 consists of a data acquisition board and up to four 21-unit current sensor strips, with eight auxiliary inputs. The strips are mounted on each side of the panel board along the termination points of each breaker. The conductor passes through the appropriate current sensor before terminating at the breaker. Each strip transmits the current data to the data acquisition board. The E30 can easily accommodate different panel configurations, including any combination of multi-phase breaker positions, voltage phase mapping, and breaker sizes. To configure the E30 for operation, download the NetConfig configuration software tool and the E3x Commissioning Guide

Data is transmitted using an RS-485 Modbus protocol. Each data acquisition board requires two addresses, one for each set of two current sensor strips and four auxiliary inputs. Data is updated roughly every two seconds. As a circuit approaches the user-defined threshold, the E30 activates the alarm indicators.

The E30A measures both current and power for the mains and branch circuits. The E30B measures both current and power for the mains, and current only in each circuit. The E30C measures current only for the mains and branch circuits.



*The CE mark indicates RoHS2 compliance. Please refer to the CE Declaration of Conformity for additional details.

Product Identification

E30	Description	CT Option	# of CTs
	<input type="checkbox"/>	<input type="checkbox"/>	<input type="checkbox"/>
	A = Advanced	0 = 100A, 3/4" spacing	24 = 2 strips with 12 sensors each *
	B = Intermediate	1 = 100A, 1" spacing	36 = 2 strips with 18 sensors each *
	C = Basic	2 = 100A, 18 mm spacing	42 = 2 strips with 21 sensors each
			48 = 4 strips with 12 sensors each *
			72 = 4 strips with 18 sensors each *
			84 = 4 strips with 21 sensors each

* This option available with 18 mm spacing only.

Regulatory Information

DANGER

HAZARD OF ELECTRIC SHOCK, EXPLOSION, OR ARC FLASH

- This product must be installed inside a suitable fire and electrical enclosure.
- Follow safe electrical work practices. See NFPA 70E in the USA, or applicable local codes.
- This equipment must only be installed and serviced by qualified electrical personnel.
- Do not use this product for life or safety applications.
- Do not install this product in hazardous or classified locations.
- Read, understand and follow the instructions before installing this product.
- Turn off all power supplying equipment before working on or inside the equipment.
- Product may use multiple voltage/power sources. Disconnect ALL sources before servicing.
- Use a properly rated voltage sensing device to confirm that power is off. DO NOT depend on this product for voltage indication.
- Current transformer secondaries (current mode) must be shorted or connected to a burden at all times.
- Products rated only for basic insulation must be installed on insulated conductors.
- Replace all doors, covers and protective devices before powering the equipment.
- The installer is responsible for conformance to all applicable codes.

Failure to follow these instructions will result in death or serious injury.

A qualified person is one who has skills and knowledge related to the construction and operation of this electrical equipment and installations, and has received safety training to recognize and avoid the hazards involved. NEC Article 100
 If this product is used in a manner not specified by the manufacturer, the protection provided by the product may be impaired. No responsibility is assumed by the manufacturer for any consequences arising out of the use of this material.

Control system design must consider the potential failure modes of control paths and, for certain critical control functions, provide a means to achieve a safe state during and after a path failure. Examples of critical control functions are emergency stop and over-travel stop.

WARNING

LOSS OF CONTROL

- Assure that the system will reach a safe state during and after a control path failure.
- Separate or redundant control paths must be provided for critical control functions.
- Test the effect of transmission delays or failures of communication links.¹
- Each implementation of equipment using communication links must be individually and thoroughly tested for proper operation before placing it in service.

Failure to follow these instructions may cause injury, death or equipment damage.

¹For additional information about anticipated transmission delays or failures of the link, refer to NEMA ICS 1.1 (latest edition). *Safety Guidelines for the Application, Installation, and Maintenance of Solid-State Controls* or its equivalent in your specific country, language, and/or location.

FCC PART 15 INFORMATION

NOTE: This equipment has been tested by the manufacturer and found to comply with the limits for a class B digital device, pursuant to part 15 of the FCC Rules. These limits are designed to provide reasonable protection against harmful interference when the equipment is operated in a residential environment. This equipment generates, uses, and can radiate radio frequency energy and, if not installed and used in accordance with the instruction manual, may cause harmful interference to radio communications. This device complies with part 15 of the FCC Rules. Operation is subject to the following two conditions:

- (1) This device may not cause harmful interference, and
- (2) this device must accept any interference received, including interference that may cause undesired operation.

Modifications to this product without the express authorization of the manufacturer nullify this statement.

Specifications

INPUTS	
Measurement Voltage	90 to 300 Vac line-to-neutral, 50/60 Hz
Control Power	90 to 277 Vac line-to-neutral, 50/60 Hz
ACCURACY	
Power/Energy	IEC 62053-21 Class 1, ANSI C12.1-2008 system accuracy (including branch CTs)
Voltage	±0.5% of reading 90 to 277 V line-to-neutral
OPERATION	
Sampling Frequency	2560 Hz
Update Rate	1.8 seconds (both panels)
OUTPUTS	
Type	Modbus RTU
Connection	DIP switch-selectable 2-wire or 4-wire, RS-485
Address	DIP switch-selectable address 1 to 247 (in pairs of two)*
Baud Rate	DIP switch-selectable 9600, 19200, 38400
Parity	DIP switch-selectable NONE, ODD, EVEN
Communication Format	8 data bits, 1 start bit, 1 stop bit
Termination	5-position depluggable connector (TX+ TX- SHIELD TX+/RX+ TX-/RX-)
WIRE SIZE RANGE	
Aux CT Terminals on Main Board	24 to 14 AWG
Removable Connectors on Main Board	22 to 12 AWG
TERMINAL BLOCK TORQUE	
Aux CT Terminals on Main Board	3.5 to 4.4 in-lb (0.4 to 0.5 N-m)
Removable Connectors on Main Board	4.4 to 5.3 in-lb (0.5 to 0.6 N-m)
MECHANICAL	
Ribbon Cable Support	4 ft. (0.9 m) round ribbon cable ships standard; up to 20 ft. (6 m) flat or round available
ENVIRONMENTAL	
Operating Temperature Range	0 to 60 °C (32 to 140 °F) (<95% RH non-condensing)
Storage Temperature Range	-40 to 70 °C (-40 to 158 °F)
Altitude of Operation	3000 m max.
COMPLIANCE INFORMATION	
Approvals	UL508 open type device**, IEC/EN61010-1
Installation Category	Cat III, pollution degree 2***
Conducted and Radiated Emissions	FCC part 15 Class B, EN55011/EN61000-6-3 Class B (residential and light industrial)
Conducted and Radiated Immunity	EN 61000-6-2 and EN 61326-1 (heavy industrial)

*See Configuration section for details.

**The E30 Series must be installed in an appropriate electrical and fire enclosure per local regulations. If Veris E30 products are used in installations with circuits higher than the product ratings, the circuits must be kept segregated per UL508A Sec. 17.5. Note: E3x internal circuitry (cables and CTs) are not circuits as defined by UL508A, as they do not extend beyond the E3x itself without further safety/fire isolation.

***A Pollution Degree 2 environment must control conductive pollution and the possibility of condensation or high humidity. Consideration must be given to the enclosure, the correct use of ventilation, thermal properties of the equipment and the relationship with the environment.

Table of Contents

Dimensions	5
Product Diagram	6
Data Outputs	7
Blink Codes for Status LED	9
Solid-Core Current Sensors	9
Installation	9
Wiring	13
Configuration	15
Default DIP Switch Settings	17
Address Setup	18
Commissioning	19
Recommended Accessories	19
Safety	19
Troubleshooting	20
China RoHS Compliance Information (EFUP Table)	20
Appendix: Panel Configuration Diagrams and Selection Matrix	21



This symbol indicates an electrical shock hazard exists.



Documentation must be consulted where this symbol is used on the product.

Dimensions

Circuit Board and Mounting Bracket

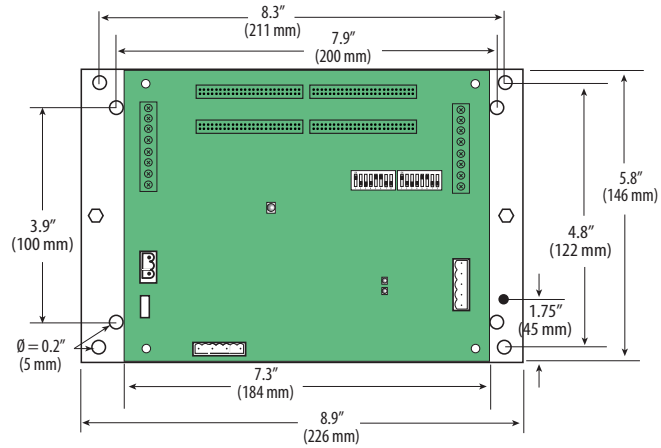

Solid-Core Current Sensor Strips

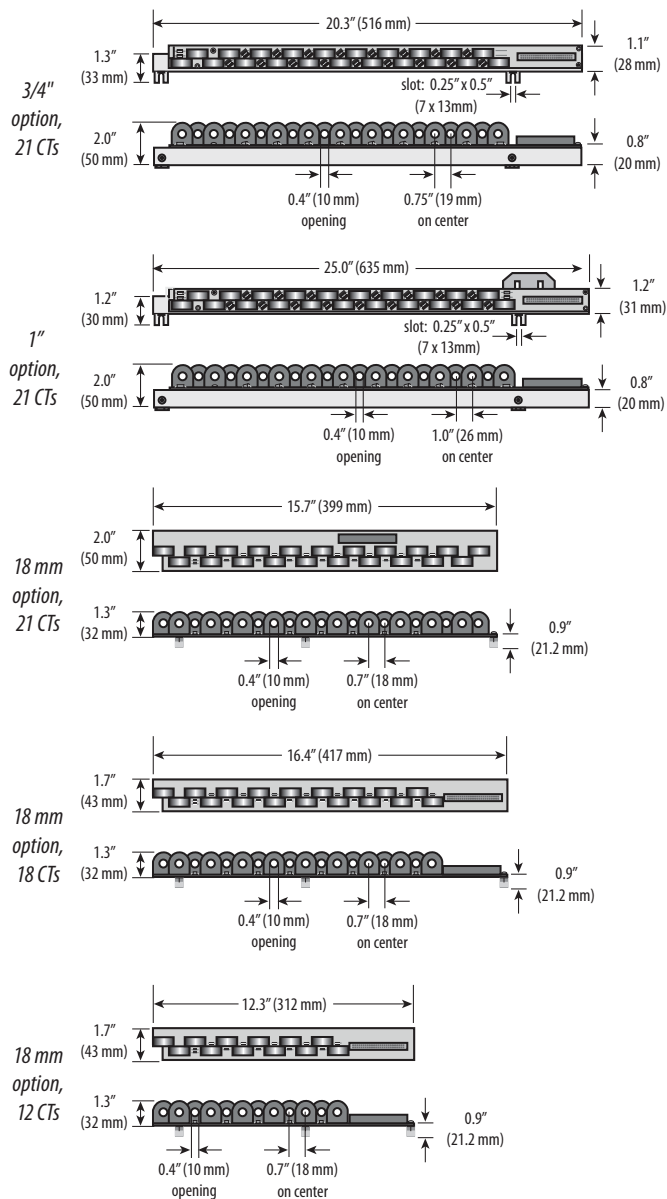

Product Diagram

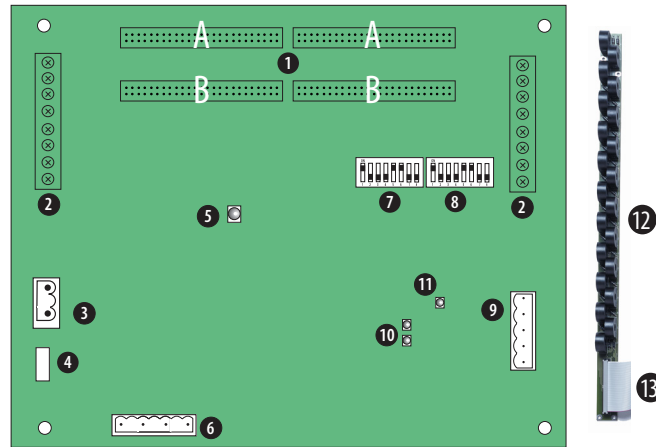

- 50-Pin Ribbon Cable Connectors (Data Acquisition Board):** 48-inch (1220 mm) ribbon cables are provided for easy connection of current sensor strips to this point of the data acquisition board. The two connectors on the left are for panelboard 1; the two on the right are for panelboard 2.

Connect current sensor strips to the correct ribbon cable connectors for each panel. The top connector is for Strip A, and the bottom connector is for Strip B.

Verify that the serial numbers on the current sensor strips match the serial number on the data acquisition board.

- Auxiliary CT Inputs:** These 0.333 Vac inputs are used for monitoring the main breaker or other high amperage source. Inputs on the left are for panelboard 1; inputs on the right are for panelboard 2.
- Control Power Connection:** Provides power to operate the meter.
- Control Power Fuse:** 600 Vac, 500 mA time lag, factory-replaceable.
- Alive LED:** Red/green/amber LEDs. Information on blink codes is provided in the Blink Codes for Status LED section.
- Voltage Taps:** 1, 2, or 3 phase plus neutral connections. For voltage sensing and power calculations (no voltage taps on the E30C).
- Communications Address DIP Switches:** Each Modbus device must have a unique address. Switches are binary weighted. Left-most switch has a value of 1; right-most switch has a value of 128. Note: the 4-strip model uses two addresses.
- Communications Settings DIP Switch:** Configures baud rate, parity, 2/4 wire communications.
- RS-485 2 Connection:** Used for Modbus serial communications. The Universal plug accommodates 2 or 4 wire connections.
- RS-485 LEDs:** The RX LED (closest to DIP switches) indicates the RS-485 is receiving information; the TX LED (farthest from DIP switches) indicates transmission of information.
- Power LED:** Indicates power to the main board
- Current Sensors:** For monitoring branch current.
- 50-Pin Ribbon Cable Connectors (Current Sensor Strips):** Connects current signal from the sensor strip to the main board via the ribbon connectors.

Data Outputs

The E30 provides several types of measurements that give a comprehensive view of power consumption for every load on the panel (the table below shows which measurements are offered on each model):

- Real-time measurements: A live and up-to-date view of present power levels and the factors that affect them.
- Demand measurements: Averages of values measured over a specified time interval. The time interval (typically 15 minutes) can be set from 10 seconds to more than a day. The demand calculation can be configured to use single intervals or the sliding average of up to six sub-intervals. Demand measurements are useful for tracking or graphing load levels over time to correlate with total energy consumption.
- Historic maximum measurements: These measurements store the largest value recorded for a specific measurement since the last time they were cleared. They are useful for identifying peak levels critical to equipment sizing or demand limits in utility agreements.
- Accumulated energy measurements: Ongoing totals of cumulative energy used since the last time the value was cleared. Energy values provide the informational basis for billing, cost allocation, carbon offset, BTU equivalent calculations, and other applications of overall energy use.
- Energy snapshots: Energy totals that only change when the demand intervals are updated. They are samples of the free-running energy accumulators at the end of each demand interval, as configured by the user. These provide energy readings that are easily correlated to the demand values to simplify the tasks of sub-billing and cost allocation.
- Alarms: Provide a warning of excessively high or low current on each branch and aux channel. The user can set two high-level and two low-level thresholds, and a delay time for latching alarms. Alarms are reported as both non-latched vents and latched events. Non-latching alarms are active while the current exceeds the threshold, but go inactive if the current returns to a level within the specific thresholds. Latching alarms become active when the current exceeds the threshold for a time period greater than the specified delay and remain active until they are cleared remotely.
- Alarm status can be polled via Modbus.

Advanced Features - Some models, especially the E30A support a number of advanced features. Some are always active, and others are configured manually via Modbus register 62017). For models with 42 channels or more, these features are configured independently for each panel.

- Logical meter support: The E30 can be configured to map any set of 1, 2 or 3 channels that are adjacent in the panel to a logical meter, referred to in the point map as a logical circuit, that provides accurate multi-phase measurement totals. Map these logical circuits by writing the desired logical circuit number into a set of registers/data objects provided for each branch and aux channel (per panel).
- The channels assigned to each logical circuit must be adjacent in the panel (usually used for multi-phase breakers), but there are no limitations on where those adjacent channels are aligned in the panel (any position where a multi-phase breaker can be installed). This functionality is always active, but a user selection affects the how the data can be accessed via Modbus. Measurement data via Modbus for logical circuits is presented in two ways, arranged either by logical circuit number (looks more like a collection of individual meters) or by measurement type (arranged similar to the single-phase data section of the point map).
- Legacy point map or alternate logical circuit point map: The E30 can be configured to select a preferred version of the Modbus registers in the address range 4000 to 9999. If enabled (default), the logical circuits by measurement type is active. Otherwise, the legacy point maps for 2-phase and 3-phase breakers used in E3x models with a firmware version earlier than 1.023 is active. The logical circuits functionality can also be accessed via the "Logical Circuits by Circuit" section of the point map (address range 10000 to 45000), regardless of the state of this selection.
- Phase angle measurements: The E30 measures the phase angle of every voltage and current input and presents these measurements (in degrees) in additional data registers/objects. These values are used to verify that current inputs are assigned to the proper voltage phases and to help determine how power factor variations are influenced by current phase changes vs. harmonic distortion. Phase angle measurements are instantaneous and always active.
- User CT phase assignment: In the default mode, the E30 assigns each channel to the corresponding phase that most 3-phase panels implement, so that the user does not have worry about it. The user can opt to replace this self-assignment paradigm with a mode that allows explicit specification of the phase assignment for each channel. The explicit assignments set by the user are stored by the E30 in non-volatile memory.
- Phase angle reference: The E30 measures the phase angle of every current and voltage input. The user can select whether the phase angles are stated relative to an absolute reference (the phase angle of voltage input V1) or relative to the voltage phase assigned to that specific current input channel.
- Demand/snapshot time interval source: The E30 offers two mechanisms for driving the demand/snapshot time interval, an interval timer or an RTC (real-time clock). The legacy mode (default) uses an interval timer that does not need to be set to an absolute time. When using the interval timer the demand/snapshot interval can be set from 10 to 32767 seconds (over 9 hours). An alternate mode utilizes an RTC set to a specific date and time to synchronize the results with a larger system. The RTC must first be set in order to run and capture demand values and energy snapshots. When power is interrupted, the RTC resets to a default date and time and must be set again in order to run. When using the RTC, the demand/snapshot interval can be set from 10 to 3600 seconds (1 hour).

Data Outputs (cont.)

Monitoring of Mains		E30A	E30B	E30C
Real Time Measurements	Current: multi-phase average and per phase	■	■	■
	Current phase angle	■	■	
	Real power (kW): multi-phase total and per phase	■	■	
	Apparent power (kVA): multi-phase total and per phase	■	■	
	Power factor: multi-phase average and per phase	■	■	
	Voltage - L-L: multi-phase average and per phase	■	■	
	Voltage - L-N: multi-phase average and per phase	■	■	
	Frequency (phase A)	■	■	
Demand Measurements	Current present demand: multi-phase average and per phase	■	■	■
	Real Power (kW) present demand: multi-phase average and per phase	■	■	
Historic Maximums	Maximum instantaneous current: multi-phase average and per phase	■	■	■
	Maximum current demand: multi-phase average and per phase	■	■	■
	Maximum real power demand: multi-phase total and per phase	■	■	
Accumulated Energy	Energy (kWh): multi-phase total and per phase	■	■	
Energy Snapshots	Energy (kWh): multi-phase total and per phase	■	■	
Monitoring of Branch Circuits				
Real Time Measurements	Current: multi-phase average and per phase	■	■	■
	Current phase angle per branch	■		
	Real power (kW): multi-phase total and per phase	■		
	Apparent power (kVA): multi-phase total and per phase	■		
	Power factor: multi-phase average and per phase	■		
Demand Measurements	Current present demand: multi-phase average and per phase	■	■	■
	Real power (kW) present demand: multi-phase average and per phase	■		
Historic Maximums	Maximum instantaneous current: multi-phase average and per phase	■	■	■
	Maximum current demand: multi-phase average and per phase	■	■	■
	Maximum real power demand: multi-phase total and per phase	■		
Accumulated Energy	Energy (kWh): multi-phase total and per phase	■		
Energy Snapshots	Energy (kWh): multi-phase total and per phase	■		
Modbus Alarms				
Alarms	Voltage over/under	■	■	
	Branch current over/under	■	■	■
	Mains current over/under	■	■	

Blink Codes for Status LED

Color and Pattern	Status Description
Green, once per second	Normal operation
Amber, once per second	Volts or Amps clipping
Amber, twice per second	Invalid firmware image
Amber, three per second	Incorrect strips or strip order*
Red, solid or blink	Diagnostic event detected

*Units with firmware V1.023 or newer do not report this message.

Solid-Core Current Sensor Accuracy

	100 A Solid-Core CT
Voltage Rating	300 Vac
Measurement Range	120 A (momentary)
Temperature	0 to 60 °C
Agency	UL508 recognized, EN61010

Installation



Observe precautions for handling static sensitive devices to avoid damage to the circuitry that is not covered under the factory warranty.

Disconnect and lock out power to the electrical panel.

1. Install the current sensor strips in the panel (Figure 1).
2. Arrange the sensor strips in one of the four configurations shown in Figure 2. Adjust orientation of the circuit numbers in the field during commissioning by writing to Modbus Register 6 or use free configuration software. For more detailed installation diagrams and help identifying what circuit configuration setting to use, refer to the Appendix titled: Panel Configuration Diagrams and Selection Matrix.

Figure 1

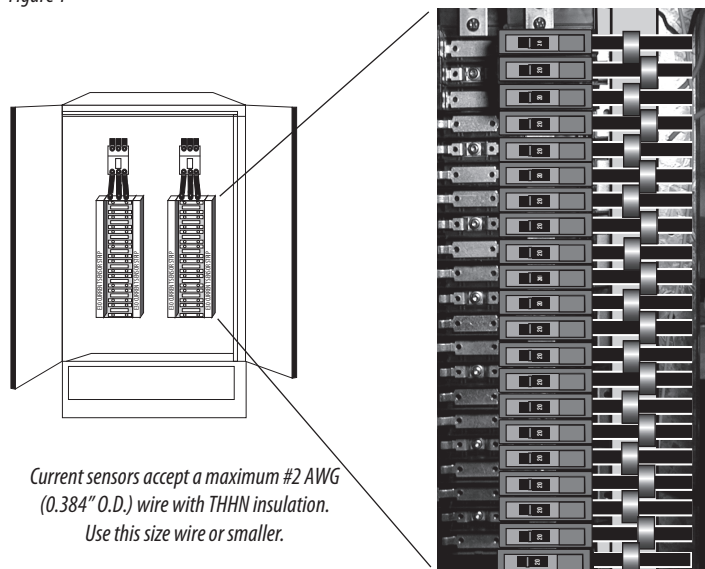

Installation (cont.)

Figure 2
 The examples in this graphic show the 21 current sensor strips.
 The same configuration options are available for the 18 and 12 strips.

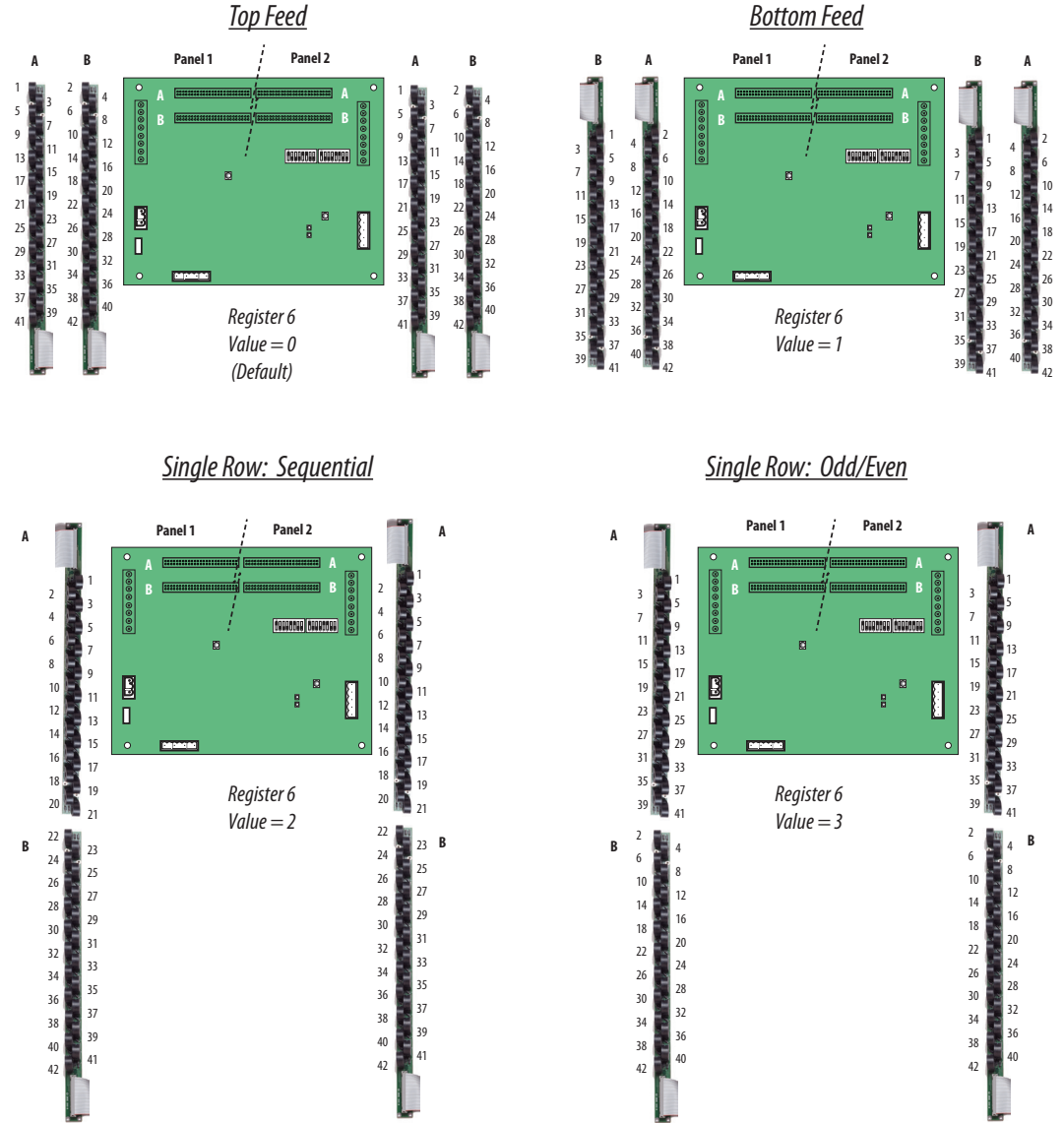

Installation (cont.)

3. Verify that the serial numbers printed on the current strip and on the data acquisition board match. **The board and the strip are sold as a calibrated set.**
4. Configure communication and addressing parameters using DIP switches. The E30 requires two addresses, one for each set of two current sensor strips and four auxiliary inputs. See the Configuration section for more information.
5. Install the E30 acquisition board mounting bracket in the panel using the screws and bolts provided (Figure 3). A grounding connection is located on the mounting bracket, near the lower right corner. Use this stud to ground the bracket when it is mounted on a nonconductive surface.

⚠ The protective ground connection on the housing should be used if the E30 will not be mounted to a suitably grounded surface. Assure conductivity to the protective ground.

Figure 3

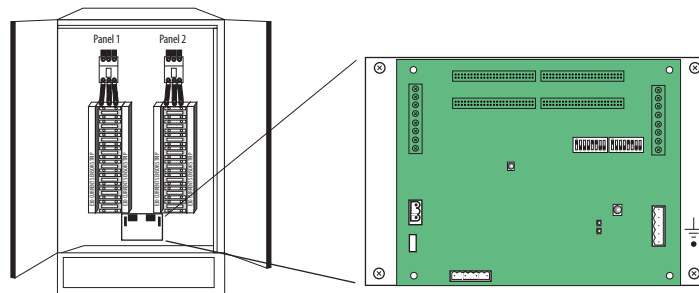

6. Check the labels on the current sensor strip and on the data acquisition board to make sure the serial numbers match. Additionally, the label indicates which connector to use on the data acquisition board (e.g. connect the strip labeled “Panel 1A” to the top left connector on the board; Figure 4).

Figure 4

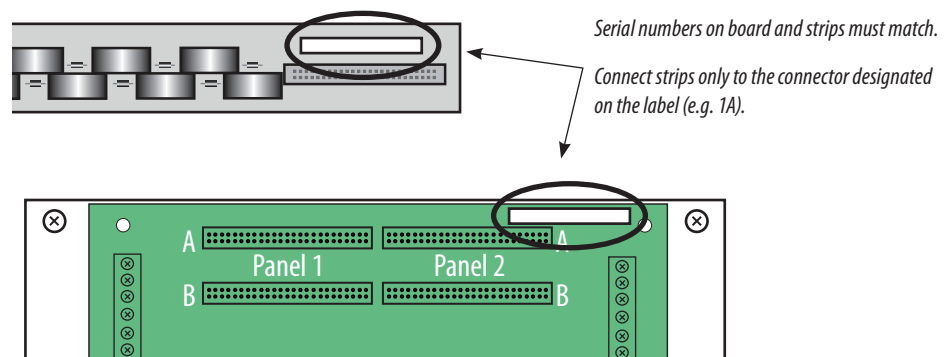

7. Connect the current sensor ribbon cables to the 50-pin connectors on the main board (Figures 5 and 6). **Orient cables so that the red stripe is on the left.**

Installation (cont.)

Figure 5

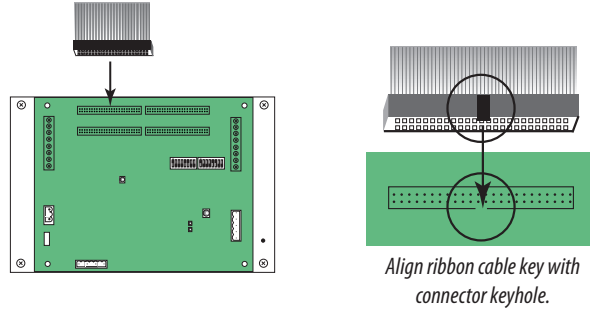
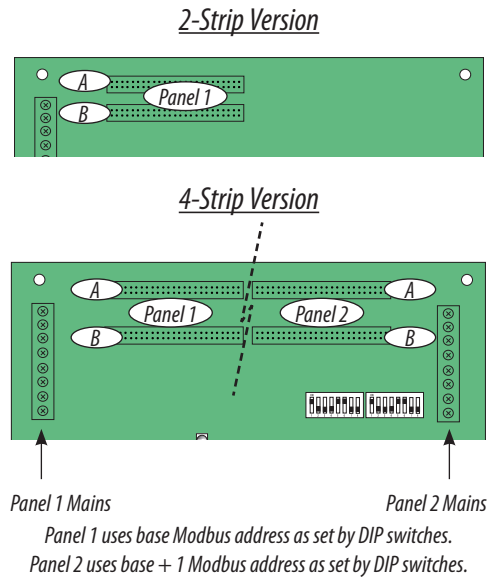

Figure 6



8. Wire RS-485 communications (see diagrams in the Wiring section).

Aux CT Installation

1. Connect 0.333 Vac CTs to the mains or other conductors, observing local codes regarding bending radius (optional; see Figure 7). Refer to the appropriate CT installation instructions for further information.

Figure 7

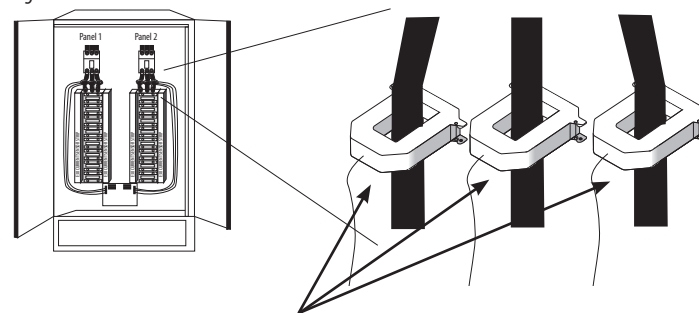

Recommended CT:

Veris Industries H6810, H6811, H6812 Series with 0.333 Vac output.

Available in 100 A max. to 2400 A max.

Call a Veris sales rep if higher amperages are required.

Wiring

DANGER

HAZARD OF ELECTRIC SHOCK, EXPLOSION, OR ARC FLASH

- While removing or installing panels and covers, assure that they do not contact an energized bus.
- NEVER bypass external fusing.
- NEVER short the secondary of a potential transformer.
- Before closing covers and doors, carefully inspect the work area and remove any tools, wire scraps or other objects that may have been left inside the equipment.

Failure to follow these instructions will result in death or serious injury.

For all steps in this section, when tightening terminals, apply the correct torque.

Aux CT inputs on main board: 3.5 to 4.4 in-lb (0.4 to 0.5 N-m); removable connectors on main board: 4.4 to 5.3 in-lb (0.5 to 0.6 N-m).

Figure 8

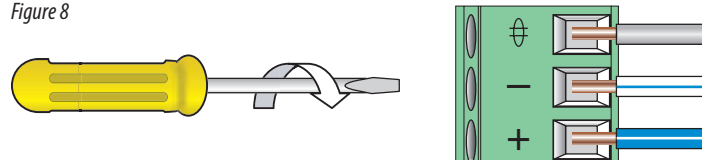

1. Connect 2-wire 90 to 277 Vac power to the main power terminals. Observe polarity. For the E30A and E30B, connect voltage lines to the voltage taps (Figure 9). Provide overcurrent protection and disconnecting means to protect the wiring. Use Veris AH02, AH03, AH04, or equivalent. Suggested: 0.5 A, time delay fuses.

Figure 9

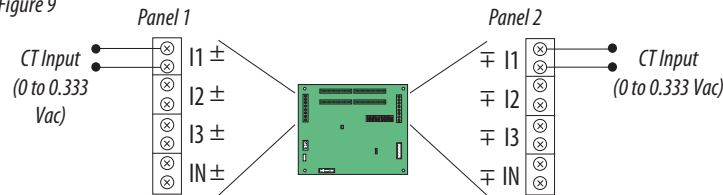

Set up Modbus registers 115-118 for CT scaling.
Use base + 1 address for Panel 2 setup.

Figure 10

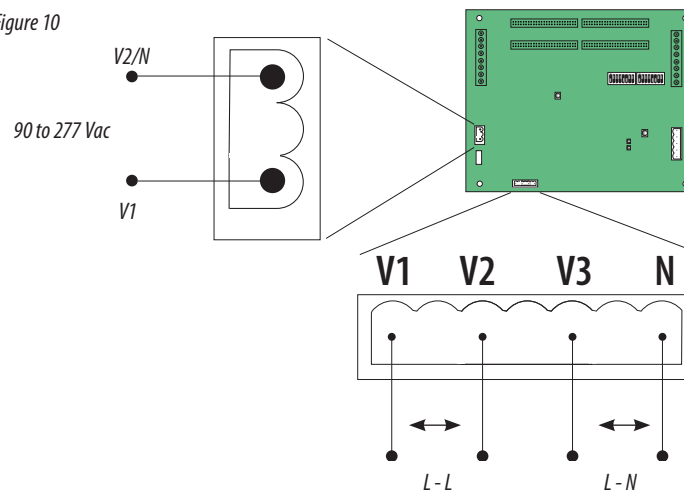

Line to Line (L-L) Voltage: 150 to 480 Vac, nominal.
Line to Neutral (L-N) voltage: 90 to 300 Vac
Voltage taps are shared by both panels.

Wiring (cont.)

Wiring configurations:

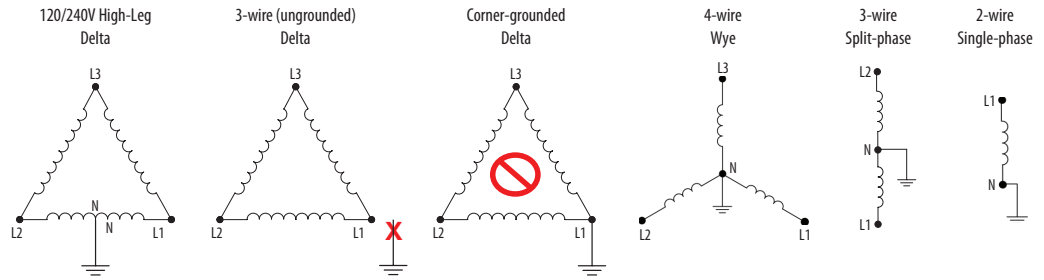

120 V/240 V Delta High Leg (where the center tap of one of the three phase-to-phase transformers is grounded): the E3x supports these applications, as long as the line-to neutral voltage [especially of the High Leg] does not exceed 300 Vac (as in North American 120/240 V High Leg Delta configurations).

In 3-wire (ungrounded) Delta applications, the E3x supports these applications with the following caveats:

Control Power for the meter cannot exceed 277 Vac. In applications where the L-L voltage is 277 Vac or less (e.g. 208 V line-to-line) it can be connected to two of the phases being monitored without exceeding the limit. For higher voltages (e.g. 480 V line-to-line), this must be supplied from a source that is 277 Vac or less. It could be a separate source or a transformer can be used to step it down from two of the phases being measured.

All of the CT inputs (both branches and Aux inputs) are neutral-referenced. One side of each CT is essentially connected directly to the neutral voltage input. If this is left floating, the solid-core CT strips, split-core CT adapter boards and all CTs will float at the same potential (while the panel is energized). This does not present a risk to the equipment as long as it is within 300 V of ground, but should be considered from a safety perspective in the overall application. The E3x will provide measurements in this application with the accuracy specified, with the exception of line-to-neutral voltages, which will be calculated and reported, based on a derived virtual neutral voltage, even though they are not relevant.

Corner-grounded delta: the E3x does not support these applications at any voltage level.

The E3x supports measurement of all 4-wire Wye, 3-wire split-phase and 2-wire single phase and configurations that operate between 90 and 300 Vac line-to neutral.

⚠ Disconnect and lock out power before making any wiring connections.

2. Connect 2-wire or 4-wire Modbus RS-485 daisy chain network (Figures 11 and 12).

Figure 11

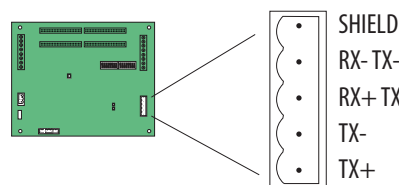
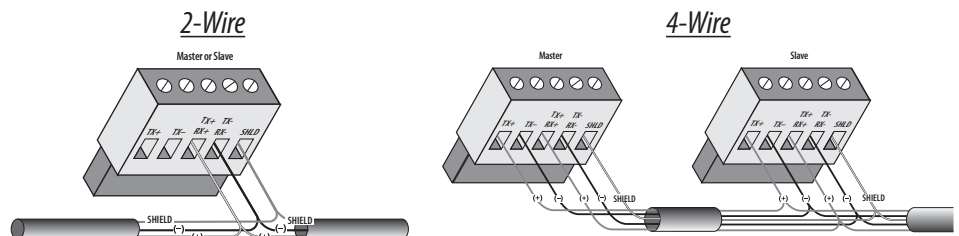

Figure 12



Wiring (cont.)

3. Mechanically secure the RS-485 cable(s) where they enter the electrical panel.
4. Connect all RS-485 devices in a daisy-chain fashion, and properly terminate the chain (Figure 13).
5. Shield the RS-485 cable using twisted-pair wire. Use cable that is voltage-rated for the installation.

Figure 13

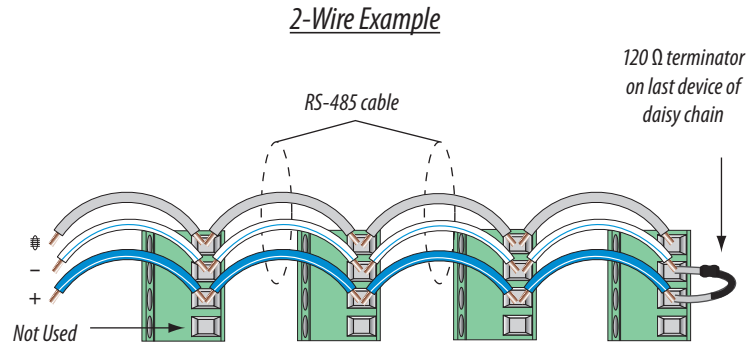

Configuration

1. Communications Configuration: Communications parameters for the E30 series are field selectable for your convenience. See the Product Diagram section for selector location. The following parameters are configurable:

- Baud Rate: 9600, 19200, 38400
- Parity: on or off
- Parity: odd or even
- Wiring: two or four

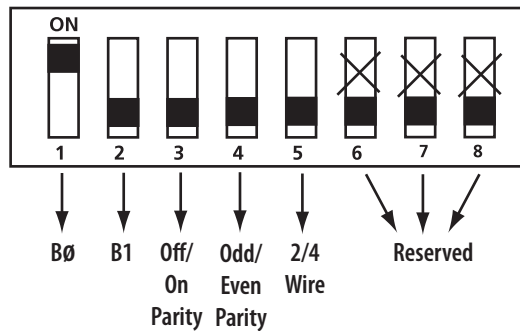

Configuration (cont.)

Example: 2-wire 19200 Baud No Parity (Default Only)

1	2	3	4	5	6	7	8	
off	off				X	X	X	9600
on	off				X	X	X	19200
off	on				X	X	X	38400
on	on				X	X	X	Reserved
		off	off		X	X	X	No Parity
		on	off		X	X	X	Odd Parity
		off	on		X	X	X	No Parity
		on	on		X	X	X	Even Parity
				on	X	X	X	4-wire RS-485
				off	X	X	X	2-wire RS-485

- Address Configuration: Each Modbus device on a single network must have a unique address. Set the switch block to assign a unique address before the device is connected to the Modbus RS-485 network. If an address is selected that conflicts with another device, neither device will be able to communicate.
- The E30 uses two logical addresses. Panel 1 uses the base address as set on the DIP switches, and Panel 2 uses this base address + 1. Address the E30 as any whole number between and including 1-246. Each unit is equipped with a set of eight DIP switches for addressing. See below.

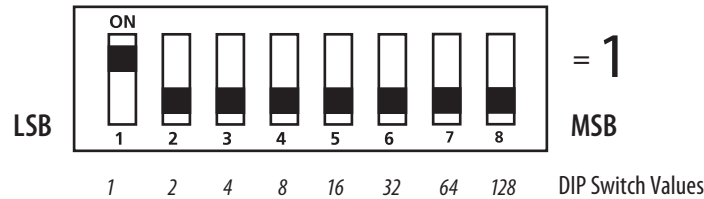

4. To determine an address, simply add the values of any switch that is on.

For example:

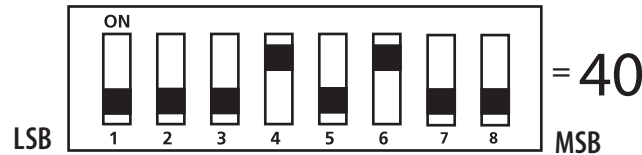

Switch number 4 has an ON value of 8 and switch number 6 has an ON value of 32.

(8 + 32 = 40). Therefore, the address for Panel 1 is 40, and the address for Panel 2 is 41.

See the Address Setup section for a pictorial listing of the first 63 switch positions.

Default DIP Switch Settings

The E30 includes two DIP switches, as shown below. Switches are shown in their default positions.

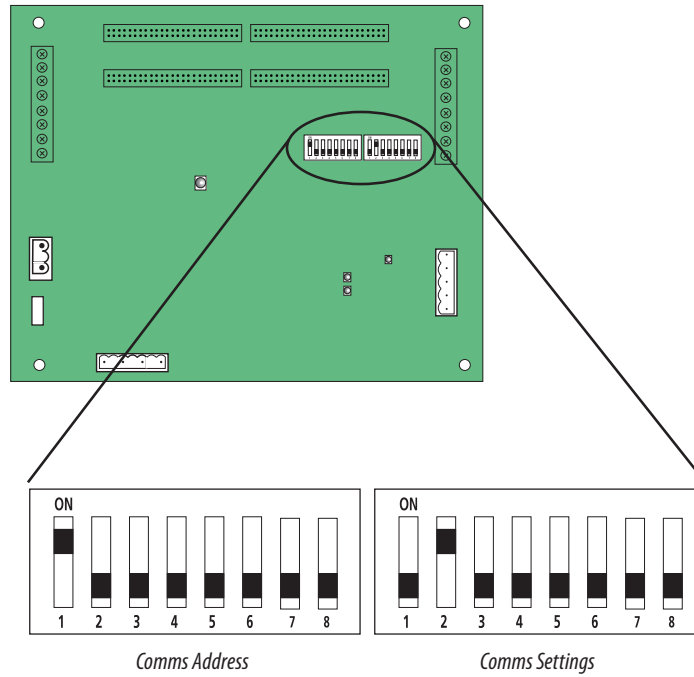

Address Setup

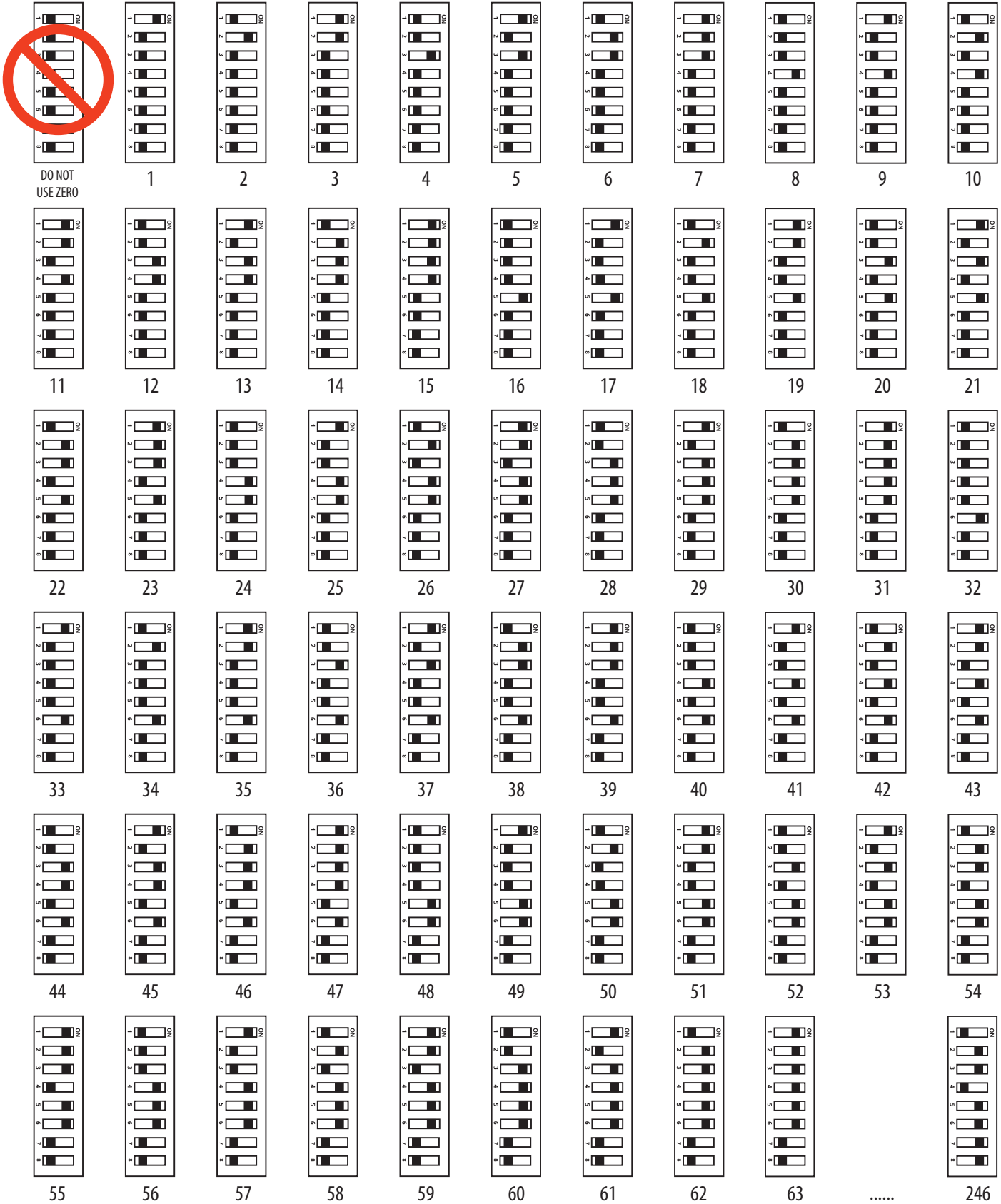

Commissioning

1. Reconnect power to the panel.
2. Configure installation mode using Modbus Register 6.
3. Configure CT scaling.
4. Configure alarms.
5. Configure demand.

Download the free E3x configuration tool

Recommended Accessories

Part ID	Description
CBL008	Flat ribbon cable, 50 x 28 AWG, 1.5 ft. (0.45 m)
CBL016	Flat ribbon cable, 50 x 28 AWG, 4 ft. (1.2 m)
CBL017	Flat ribbon cable, 50 x 28 AWG, 5 ft. (1.5 m)
CBL018	Flat ribbon cable, 50 x 28 AWG, 6 ft. (1.8 m)
CBL019	Flat ribbon cable, 50 x 28 AWG, 8 ft. (2.4 m)
CBL020	Flat ribbon cable, 50 x 28 AWG, 10 ft. (3.0 m)
CBL021	Flat ribbon cable, 50 x 28 AWG, 20 ft. (6.1 m)
CBL022	Round ribbon cable, 50 x 28 AWG, 4 ft. (1.2 m)
CBL023	Round ribbon cable, 50 x 28 AWG, 10 ft. (3 m)
CBL024	Round ribbon cable, 50 x 28 AWG, 20 ft. (6 m)
CBL025	Flat ribbon cable, 50 x 28 AWG, 2 m
CBL026	Flat ribbon cable, 50 x 28 AWG, 4 m
CBL027	Flat ribbon cable, 50 x 28 AWG, 6 m
CBL031	Round ribbon cable, 50 x 28 AWG, 1.5 ft. (0.45 m)
CBL032	Round ribbon cable, 50 x 28 AWG, 2.5 ft. (0.76 m)
AE001	E3x MCB cover
AE006	E30 CT repair kit
E8951	Modbus to BACnet protocol converter

Troubleshooting

Problem	Solution
Product is not communicating over Modbus daisy chain	<ul style="list-style-type: none"> • Check the unit Modbus address to ensure that each device on the daisy chain has a unique address. • Check Parity. • Check the communications wiring. • Check that the daisy chain is properly terminated.
RX LED is solid	<ul style="list-style-type: none"> • Check for reversed polarity on Modbus comms. • Check for sufficient biasing on the Modbus bus. Modbus physical specification calls for 450-650 Ω biasing. This is usually provided by the master.
The main board has a fast flashing amber light	<ul style="list-style-type: none"> • Check that the 1A and 1B CT strips are connected to the left top and left bottom ribbon cable connections; 2A and 2B must be connected to the right top and right bottom ribbon cable connections (see illustrations in the product installation guide). • Verify ribbon cable connectors are inserted in the correct orientation. • If cables are correct, reset main board to re-initialize product.
The main board has a slow flashing amber light	<ul style="list-style-type: none"> • One or more channels is clipping. This can be caused by a signal greater than 100 A or 277 V L-N, or by a signal with high THD near the gain stage switching points (1.5 A and 10 A).
The main board has a flashing green light	<ul style="list-style-type: none"> • Everything is wired properly and the main board has power.
The main board is a flashing or solid red light	<ul style="list-style-type: none"> • Light may be red briefly while device powers up. • If light is red for more than 60 seconds, the device has encountered a diagnostic event. Contact Veris technical support.
Power factor reading is not as expected	<ul style="list-style-type: none"> • Verify voltage taps are connected in appropriate phase rotation. • Verify strip configuration register matches actual strip installation. • Verify phase rotation of breakers (firmware rev. 1.012 or higher allows for custom rotation if needed).
Current reading is not as expected, or reading is on different CT number than expected	<ul style="list-style-type: none"> • Verify strip configuration register matches actual strip installation. • Verify ribbon cable is fully seated and in the correct orientation.
Current is reading zero, even when small currents are still flowing through the circuit	<ul style="list-style-type: none"> • The product cuts off at 50 mA, and will set the reporting register to 0 mA for currents near or below this range.
E3x Config Tool returns Modbus error on read/write	<ul style="list-style-type: none"> • Verify use of the latest release of the E3x Config Tool as older versions may not support all features in the current product firmware.

China RoHS Compliance Information (EFUP Table)

部件名称	产品中有毒有害物质或元素的名称及含量Substances					
	铅 (Pb)	汞 (Hg)	镉 (Cd)	六价铬 (Cr (VI))	多溴联苯 (PBB)	多溴二苯醚 (PBDE)
电子线路板	X	0	0	0	0	0
0 = 表示该有毒有害物质在该部件所有均质材料中的含量均在 SJ/T11363-2006 标准规定的限量要求以下。 X = 表示该有毒有害物质至少在该部件的某一均质材料中的含量超出SJ/T11363-2006标准规定的限量要求。						
Z000057-0A						

Appendix: Panel Configuration Diagrams and Selection Matrix

To determine which installation drawing applies and which configuration to select for each logical Panel of the E30, answer the following questions about your application and look up the corresponding information on the selection table below:

1. Are the rows of circuit breakers in your panelboard vertical (like most North American panels) or horizontal (like many European panels)?
2. Are the breakers arranged in a single row, in two rows, or in two separate panels, each with two rows?
3. If there are two rows of breakers, are the breakers/circuits in each row number sequentially, or are the odd numbers in one row and the even numbers in the other?
4. How many channels (branch CTs) does your E30 have?
5. For vertical dual-row panels with odd/even numbering, do the main feeds come in at the top or the bottom of the chassis?

Orientation of circuit breaker rows:	Breaker Numbering within Panel:	number of E30 channels:	Single Panelboard						Two Panelboards (or Dual-Panel PDU/RPP)		
			Single Panel <=24 Breakers	Single Panel <=36 Breakers	Single Panel <=42 Breakers	Single Panel <=48 Breakers	Single Panel <=72 Breakers	Single Panel <=84 Breakers	Two Panels <=24 Breakers each	Two Panels <=36 Breakers each	Two Panels <=42 Breakers each
			24	36	42	48	72	84	48	72	84
Vertical	Dual Row - Top Feed (with Odd/Even numbering)	Installation Diagram to use:	1	2	3	7	8	9	1	2	3
		Panel 1 Configuration setting:	Top Feed	Top Feed	Top Feed	Bottom Feed	Bottom Feed	Bottom Feed	Top Feed	Top Feed	Top Feed
		Panel 2 Configuration setting:				Top Feed	Top Feed	Top Feed	Top Feed	Top Feed	Top Feed
	Dual Row - Bottom Feed (with Odd/Even numbering)	Installation Diagram to use:	4	5	6	7	8	9	4	5	6
		Panel 1 Configuration setting:	Bottom Feed	Bottom Feed	Bottom Feed	Bottom Feed	Bottom Feed	Bottom Feed	Bottom Feed	Bottom Feed	Bottom Feed
		Panel 2 Configuration setting:				Top Feed	Top Feed	Top Feed	Bottom Feed	Bottom Feed	Bottom Feed
	Dual Row - Top Feed (with Sequential numbering)	Installation Diagram to use:	10	11	12	13	14	15	10	11	12
		Panel 1 Configuration setting:	Sequential	Sequential	Sequential	Sequential	Sequential	Sequential	Sequential	Sequential	Sequential
		Panel 2 Configuration setting:				Sequential	Sequential	Sequential	Sequential	Sequential	Sequential
	Dual Row - Bottom Feed (with Sequential numbering)	Installation Diagram to use:	10	11	12	13	14	15	10	11	12
Panel 1 Configuration setting:		Sequential	Sequential	Sequential	Sequential	Sequential	Sequential	Sequential	Sequential	Sequential	
Panel 2 Configuration setting:					Sequential	Sequential	Sequential	Sequential	Sequential	Sequential	
Single Row Vertical (with Sequential numbering)	Installation Diagram to use:	16	17	18							
	Panel 1 Configuration setting:	Sequential	Sequential	Sequential							
	Panel 2 Configuration setting:										
Dual Row - Any Feed (with Odd/Even numbering alternate strip mounting*)	Installation Diagram to use:			19*							
	Panel 1 Configuration setting:			Odd/Even							
	Panel 2 Configuration setting:										

* this configuration is used in rare circumstances where both strips don't fit in the same orientation

Orientation of circuit breaker rows:	Rows of Circuit Breakers:	number of E30 channels:	Single Row of Breakers			Two Rows of Breakers		
			<=24 Breakers	<=36 Breakers	<=42 Breakers	<=24 Breakers per row	<=36 Breakers per row	<=42 Breakers per row
			24	36	42	48	72	84
Horizontal	Single Row (with Sequential numbering)	Installation Diagram to use:	20	21	22			
		Panel 1 Configuration setting:	Sequential	Sequential	Sequential			
		Panel 2 Configuration setting:						
	Dual Row (with Sequential numbering)	Installation Diagram to use:	23	24	25	26	27	28
		Panel 1 Configuration setting:	Sequential	Sequential	Sequential	Sequential	Sequential	Sequential
		Panel 2 Configuration setting:				Sequential	Sequential	Sequential

Appendix

#1

Top of Panels ↑

24/48-ch Top Feed Configuration
Panel 1

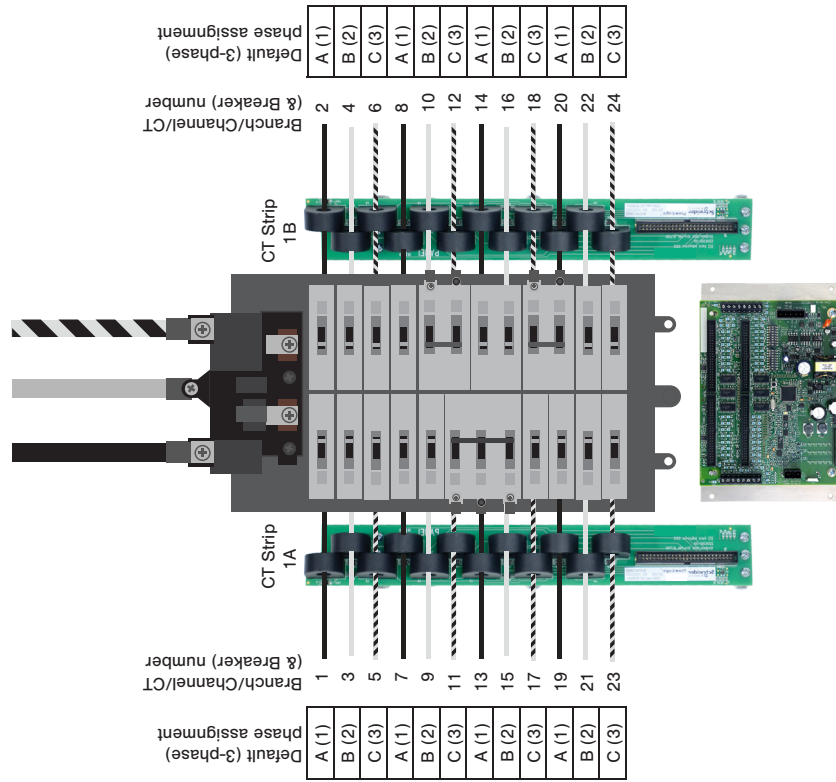

Panel 1
Set Configuration
(Modbus Register 6)
to Top Feed (0)

48-ch Top Feed Configuration
Panel 2

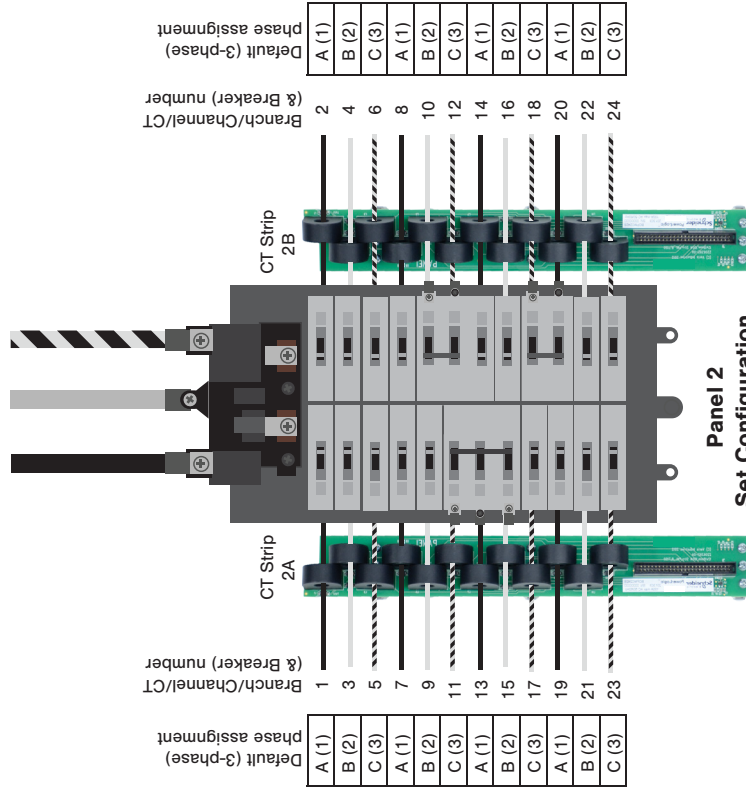

Panel 2
Set Configuration
(Modbus Register 6)
to Top Feed (0)

Appendix

Top of Panels ↑

#2

36/72-ch Top Feed Configuration Panel 1

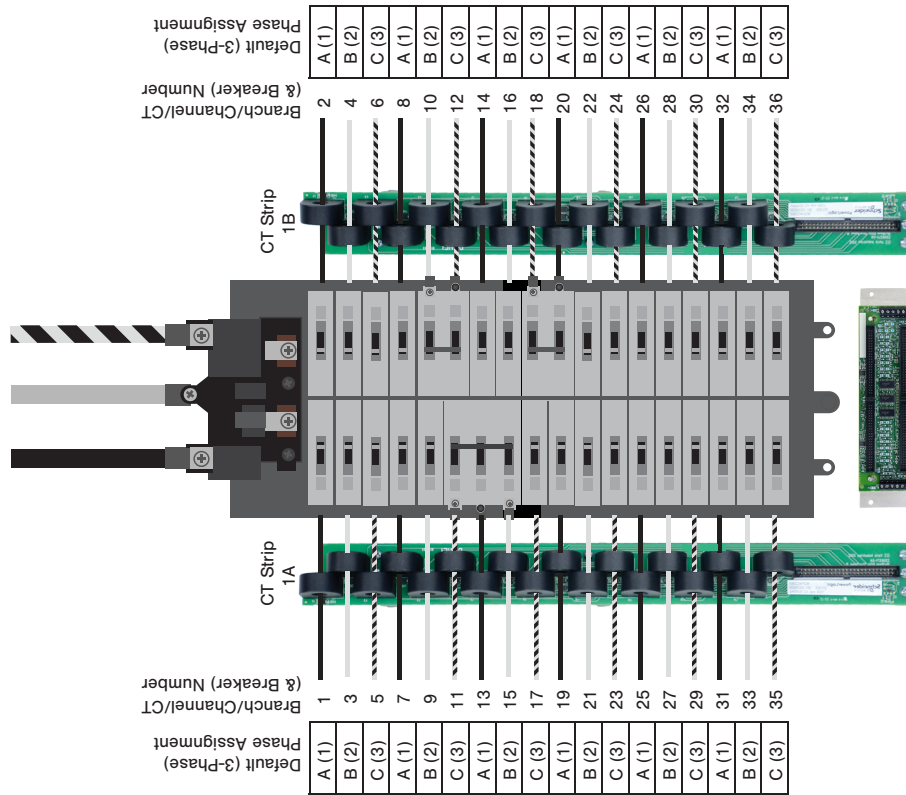

Panel 1
Set Configuration (Modbus Register 6) to Top Feed (0)

72-ch Top Feed Configuration Panel 2

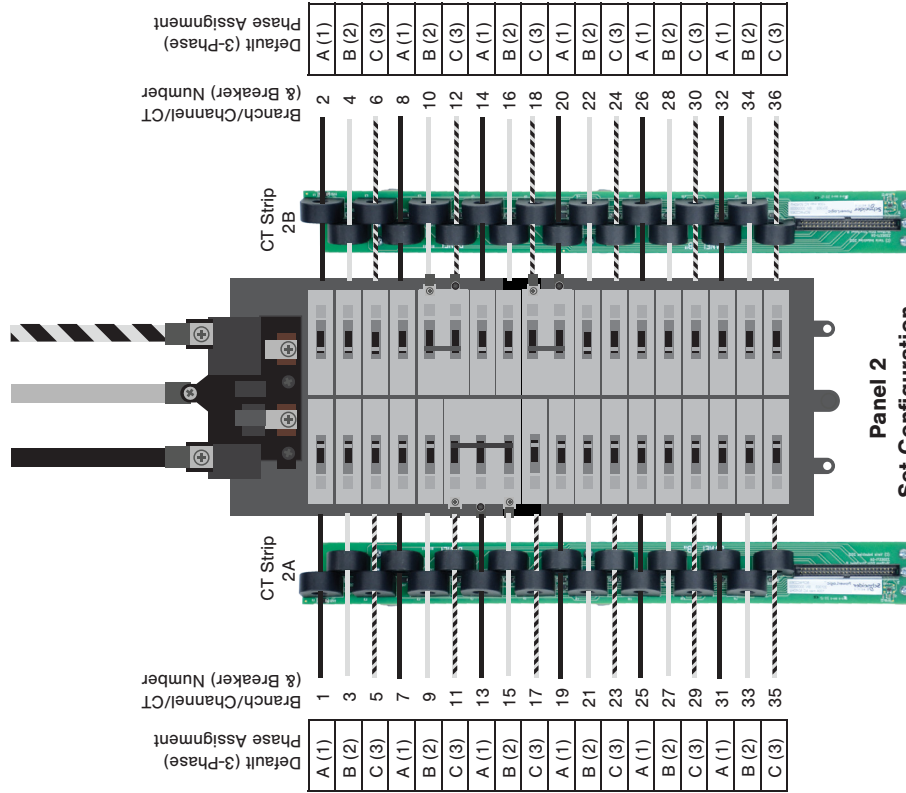

Panel 2
Set Configuration (Modbus Register 6) to Top Feed (0)

Appendix

Top of Panels ↑

#3

42/84-ch Top Feed Configuration Panel 1

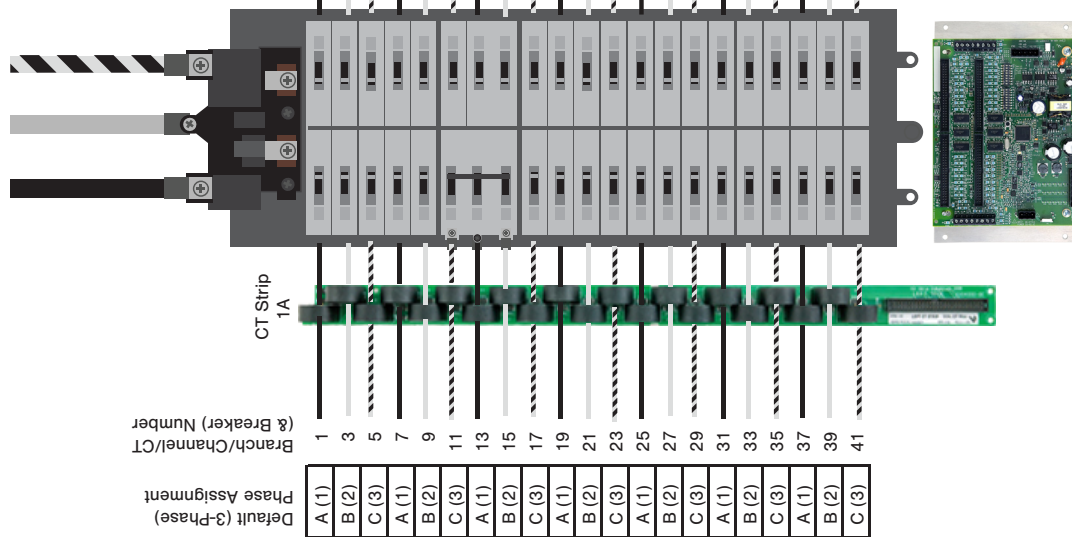

Panel 1
Set Configuration (Modbus Register 6) to Top Feed (0)

84-ch Top Feed Configuration Panel 2

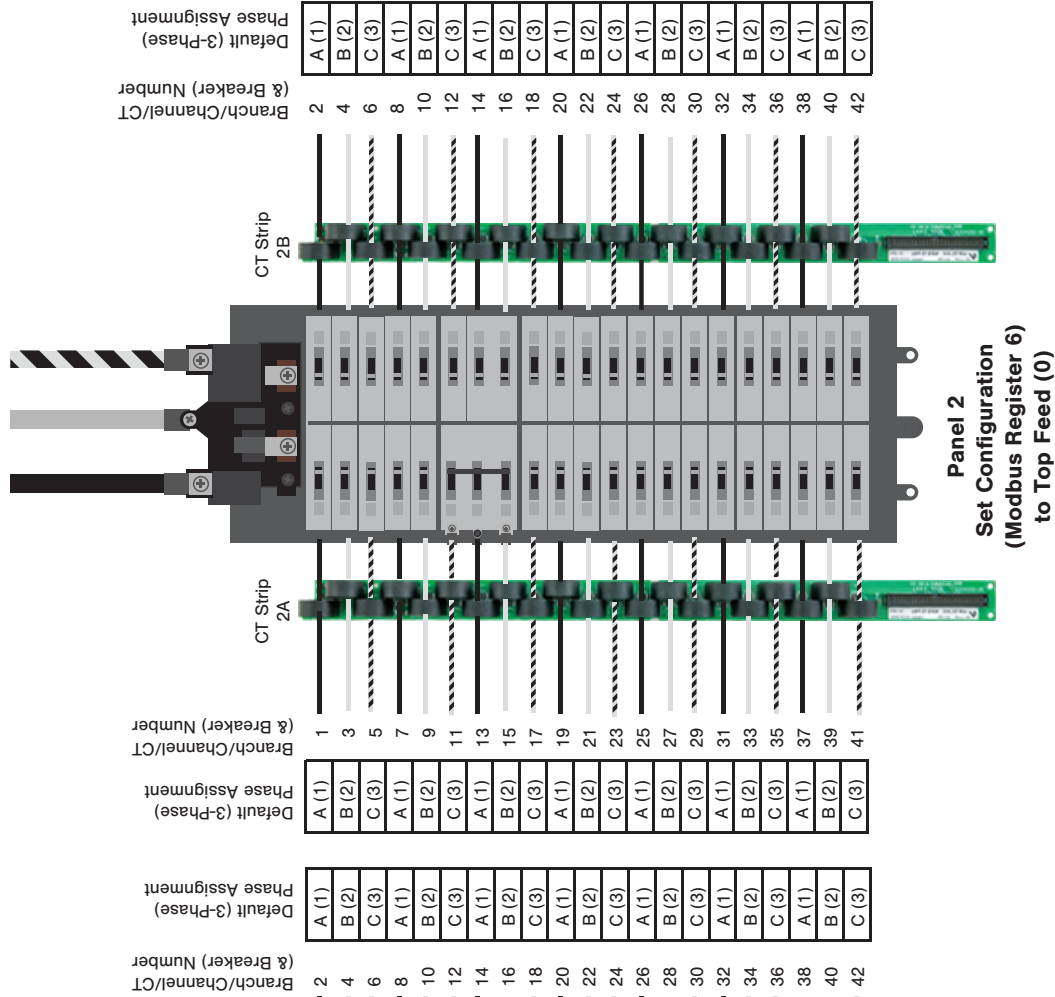

Panel 2
Set Configuration (Modbus Register 6) to Top Feed (0)

Appendix

Top of Panels ↑

#4

48-ch Bottom Feed Configuration Panel 2

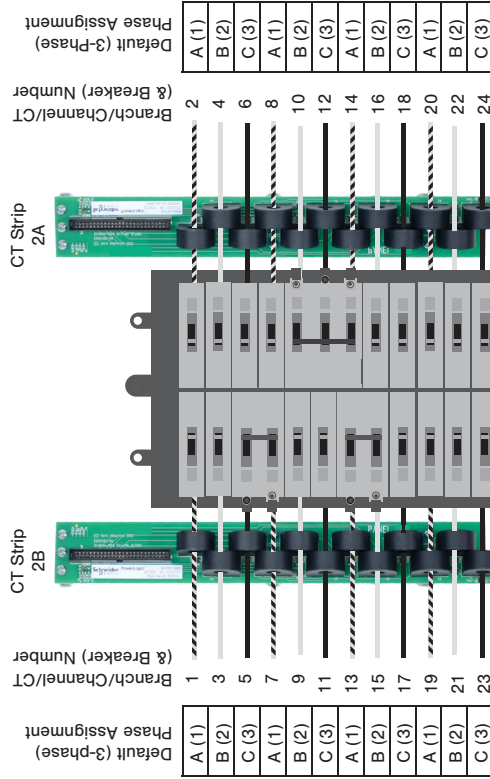

Panel 2
Set Configuration (Modbus Register 6) to Bottom Feed (1)

24/48-ch Bottom Feed Configuration Panel 1

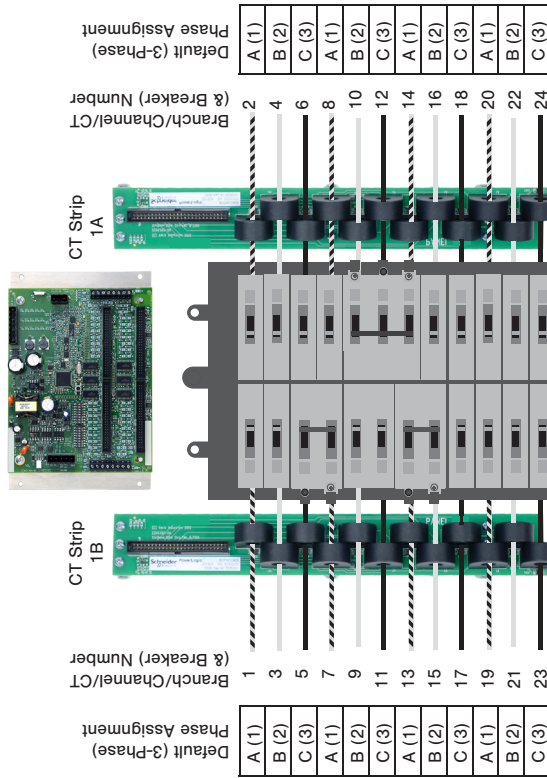

Panel 1
Set Configuration (Modbus Register 6) to Bottom Feed (1)

Appendix

Top of Panels ←

72-ch Bottom Feed Configuration Panel 2

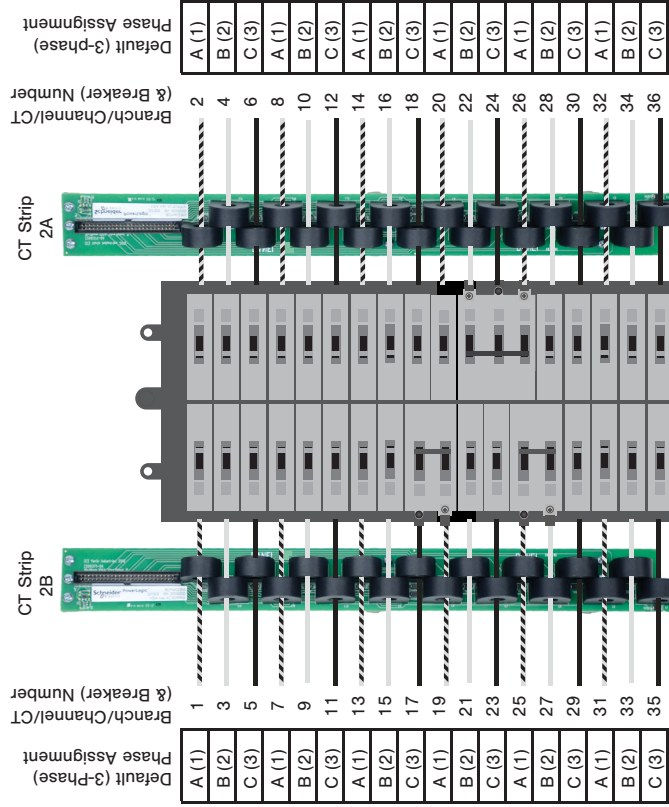

Panel 2
Set Configuration (Modbus Register 6) to Bottom Feed (1)

36/72-ch Bottom Feed Configuration Panel 1

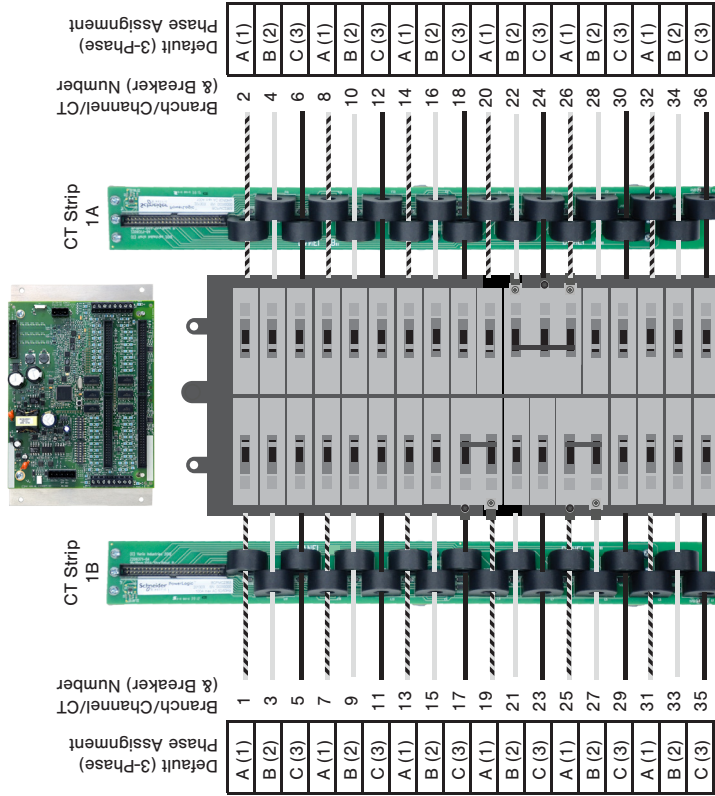

Panel 1
Set Configuration (Modbus Register 6) to Bottom Feed (1)

#5

Appendix

Top of Panels ↑

42/84-ch Bottom Feed Configuration Panel 1

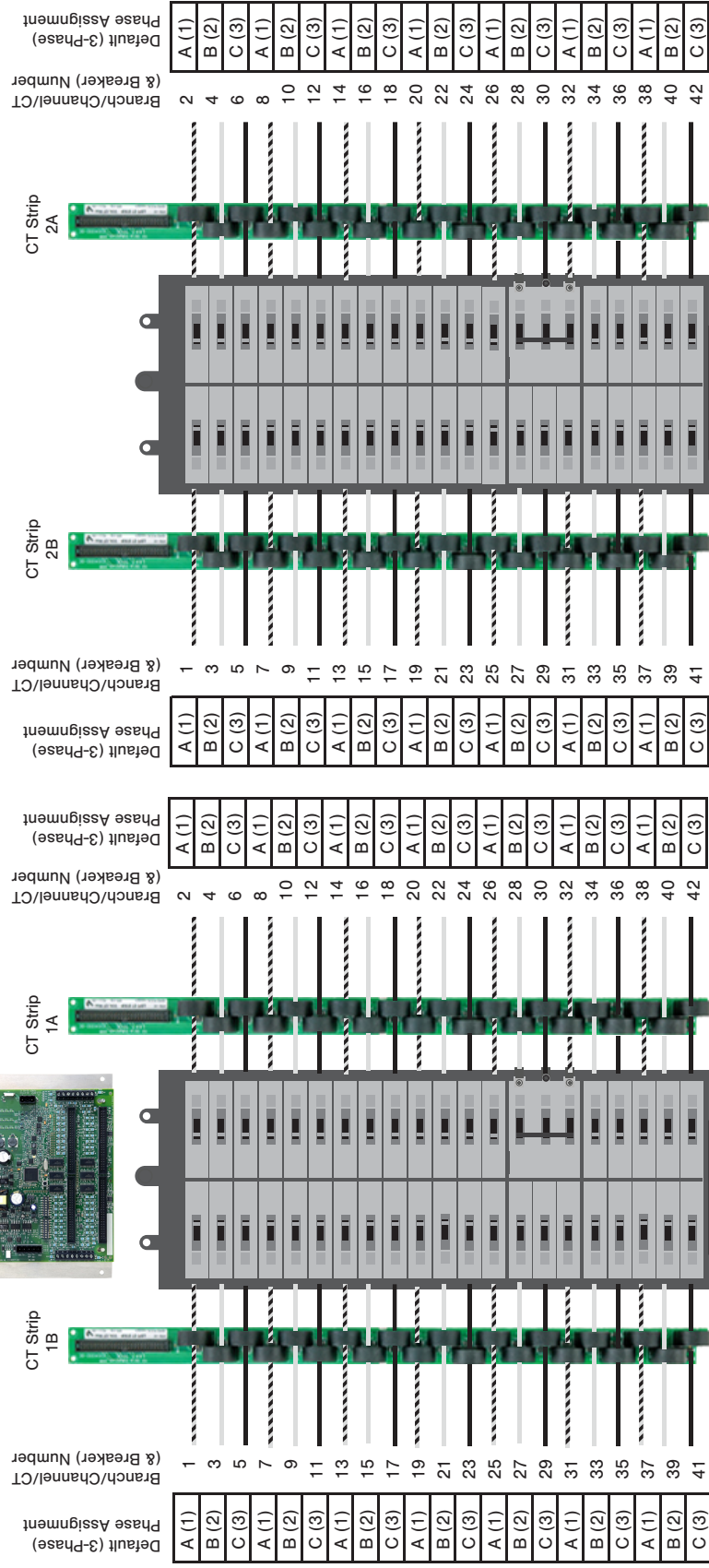
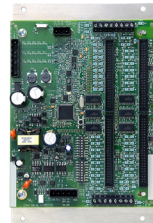

84-ch Bottom Feed Configuration Panel 2

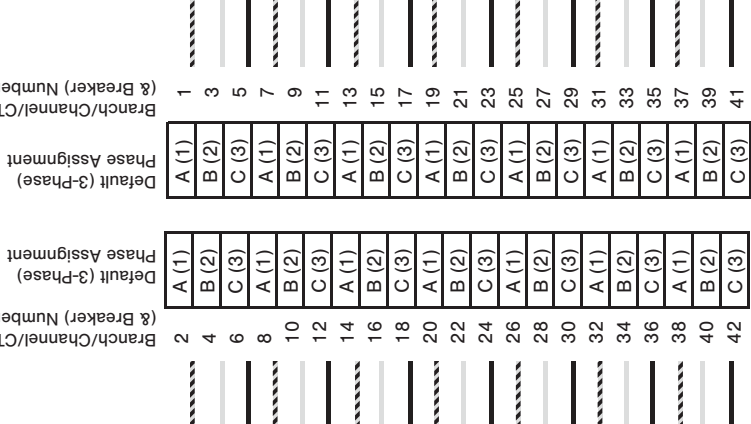
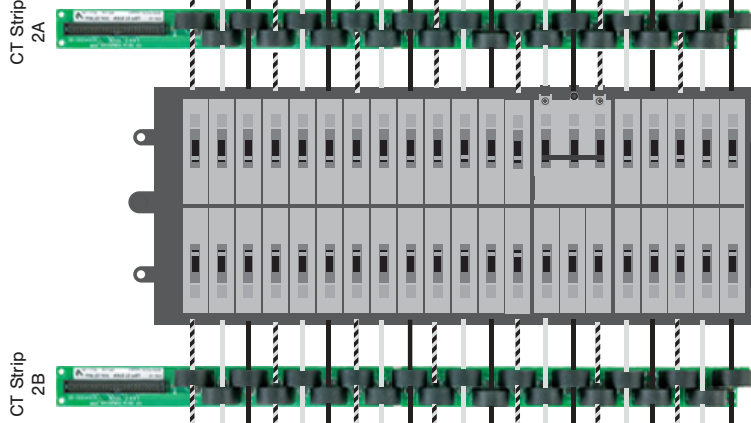

#6

Appendix

#7

Top of Panel ↑

48-ch Large Panel Odd/Even Configuration

Note: This application does NOT use the Odd/Even configuration setting.

Panel 1 (Upper Half)
Set Configuration
(Modbus Register 6)
to Bottom Feed (1)

Panel 1 (Upper Half)
Set Configuration
(Modbus Register 6)
to Bottom Feed (1)

Default (3-Phase) Phase Assignment	Branch/Channel/CT Number	Breaker Number
A (1)	1	1
B (2)	3	3
C (3)	5	5
A (1)	7	7
B (2)	9	9
C (3)	11	11
A (1)	13	13
B (2)	15	15
C (3)	17	17
A (1)	19	19
B (2)	21	21
C (3)	23	23
A (1)	1	25
B (2)	3	27
C (3)	5	29
A (1)	7	31
B (2)	9	33
C (3)	11	35
A (1)	13	37
B (2)	15	39
C (3)	17	41
A (1)	19	43
B (2)	21	45
C (3)	23	47

Breaker Number	Branch/Channel/CT Number	Default (3-Phase) Phase Assignment
2	2	A (1)
4	4	B (2)
6	6	C (3)
8	8	A (1)
10	10	B (2)
12	12	C (3)
14	14	A (1)
16	16	B (2)
18	18	C (3)
20	20	A (1)
22	22	B (2)
24	24	C (3)
26	2	A (1)
28	4	B (2)
30	6	C (3)
32	8	A (1)
34	10	B (2)
36	12	C (3)
38	14	A (1)
40	16	B (2)
42	18	C (3)
44	20	A (1)
46	22	B (2)
48	24	C (3)

Panel 2 (Lower Half)
Set Configuration
(Modbus Register 6)
to Top Feed (0)

Panel 2 (Lower Half)
Set Configuration
(Modbus Register 6)
to Top Feed (0)

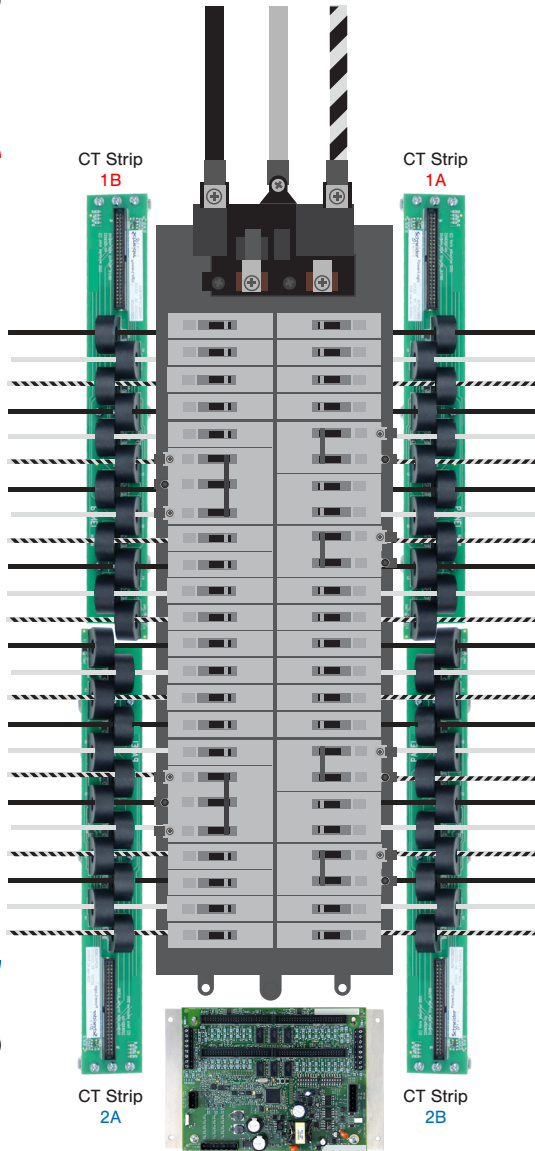

Appendix #8

Top of Panel ↑

72-ch Large Panel Odd/Even Configuration

Note: This application does NOT use the Odd/Even configuration setting.

Panel 1 (Upper Half) Set Configuration (Modbus Register 6) to Bottom Feed (1)

Default (3-Phase) Phase Assignment	Branch/Channel/CT Number	Breaker Number
------------------------------------	--------------------------	----------------

A (1)	1	1
B (2)	3	3
C (3)	5	5
A (1)	7	7
B (2)	9	9
C (3)	11	11
A (1)	13	13
B (2)	15	15
C (3)	17	17
A (1)	19	19
B (2)	21	21
C (3)	23	23
A (1)	25	25
B (2)	27	27
C (3)	29	29
A (1)	31	31
B (2)	33	33
C (3)	35	35

A (1)	1	37
B (2)	3	39
C (3)	5	41
A (1)	7	43
B (2)	9	45
C (3)	11	47
A (1)	13	49
B (2)	15	51
C (3)	17	53
A (1)	19	55
B (2)	21	57
C (3)	23	59
A (1)	25	61
B (2)	27	63
C (3)	29	65
A (1)	31	67
B (2)	33	69
C (3)	35	71

Panel 2 (Lower Half) Set Configuration (Modbus Register 6) to Top Feed (0)

Panel 1 (Upper Half) Set Configuration (Modbus Register 6) to Bottom Feed (1)

Breaker Number	Branch/Channel/CT Number	Default (3-Phase) Phase Assignment
----------------	--------------------------	------------------------------------

2	2	A (1)
4	4	B (2)
6	6	C (3)
8	8	A (1)
10	10	B (2)
12	12	C (3)
14	14	A (1)
16	16	B (2)
18	18	C (3)
20	20	A (1)
22	22	B (2)
24	24	C (3)
26	26	A (1)
28	28	B (2)
30	30	C (3)
32	32	A (1)
34	34	B (2)
36	36	C (3)

38	2	A (1)
40	4	B (2)
42	6	C (3)
44	8	A (1)
46	10	B (2)
48	12	C (3)
50	14	A (1)
52	16	B (2)
54	18	C (3)
56	20	A (1)
58	22	B (2)
60	24	C (3)
62	26	A (1)
64	28	B (2)
66	30	C (3)
68	32	A (1)
70	34	B (2)
72	36	C (3)

Panel 2 (Lower Half) Set Configuration (Modbus Register 6) to Top Feed (0)

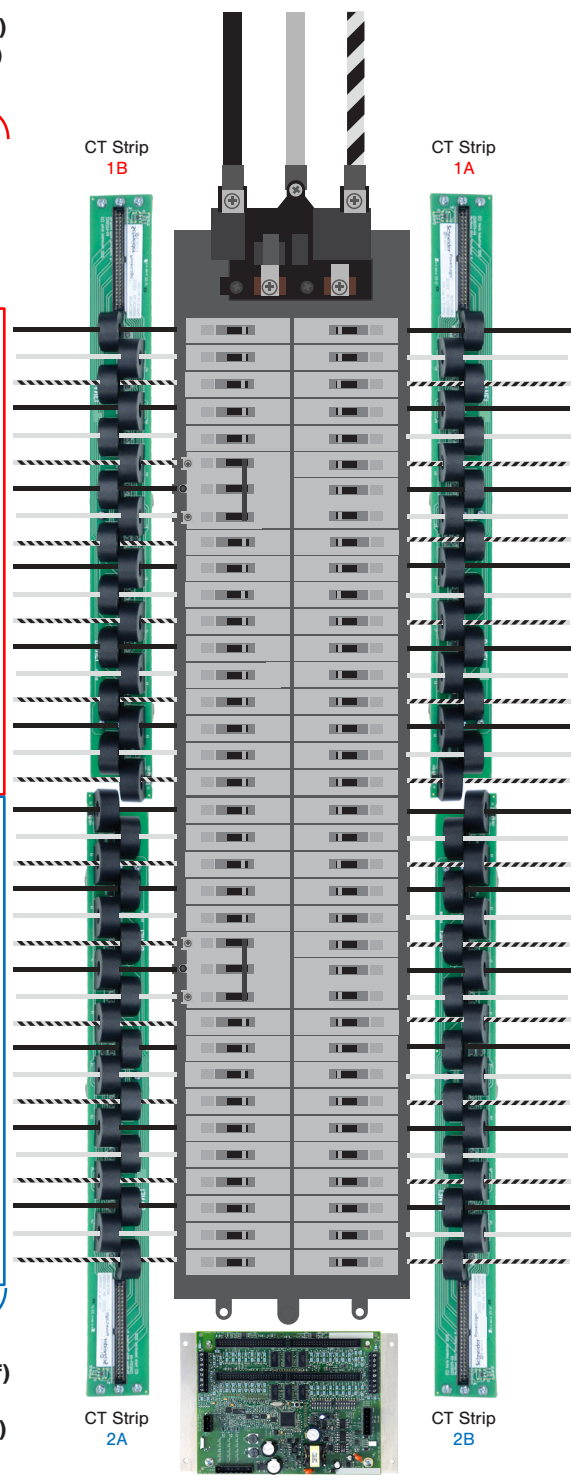

Appendix #9

Top of Panel ↑
84-ch Large Panel Odd/Even Configuration

Note: This application does NOT use the Odd/Even configuration setting.

Panel 1 (Upper Half)
 Set Configuration (Modbus Register 6) to Bottom Feed (1)

Default (3-Phase) Phase Assignment	Branch/Channel/CT Number	Breaker Number
A (1)	1	1
B (2)	3	3
C (3)	5	5
A (1)	7	7
B (2)	9	9
C (3)	11	11
A (1)	13	13
B (2)	15	15
C (3)	17	17
A (1)	19	19
B (2)	21	21
C (3)	23	23
A (1)	25	25
B (2)	27	27
C (3)	29	29
A (1)	31	31
B (2)	33	33
C (3)	35	35
A (1)	37	37
B (2)	39	39
C (3)	41	41
A (1)	1	43
B (2)	3	45
C (3)	5	47
A (1)	7	49
B (2)	9	51
C (3)	11	53
A (1)	13	55
B (2)	15	57
C (3)	17	59
A (1)	19	61
B (2)	21	63
C (3)	23	65
A (1)	25	67
B (2)	27	69
C (3)	29	71
A (1)	31	73
B (2)	33	75
C (3)	35	77
A (1)	37	79
B (2)	39	81
C (3)	41	83

Panel 1 (Upper Half)
 Set Configuration (Modbus Register 6) to Bottom Feed (1)

Breaker Number	Branch/Channel/CT Number	Default (3-Phase) Phase Assignment
2	2	A (1)
4	4	B (2)
6	6	C (3)
8	8	A (1)
10	10	B (2)
12	12	C (3)
14	14	A (1)
16	16	B (2)
18	18	C (3)
20	20	A (1)
22	22	B (2)
24	24	C (3)
26	26	A (1)
28	28	B (2)
30	30	C (3)
32	32	A (1)
34	34	B (2)
36	36	C (3)
38	38	A (1)
40	40	B (2)
42	42	C (3)
44	2	A (1)
46	4	B (2)
48	6	C (3)
50	8	A (1)
52	10	B (2)
54	12	C (3)
56	14	A (1)
58	16	B (2)
60	18	C (3)
62	20	A (1)
64	22	B (2)
66	24	C (3)
68	26	A (1)
70	28	B (2)
72	30	C (3)
74	32	A (1)
76	34	B (2)
78	36	C (3)
80	38	A (1)
82	40	B (2)
84	42	C (3)

Panel 2 (Upper Half)
 Set Configuration (Modbus Register 6) to Top Feed (0)

Panel 2 (Upper Half)
 Set Configuration (Modbus Register 6) to Top Feed (0)

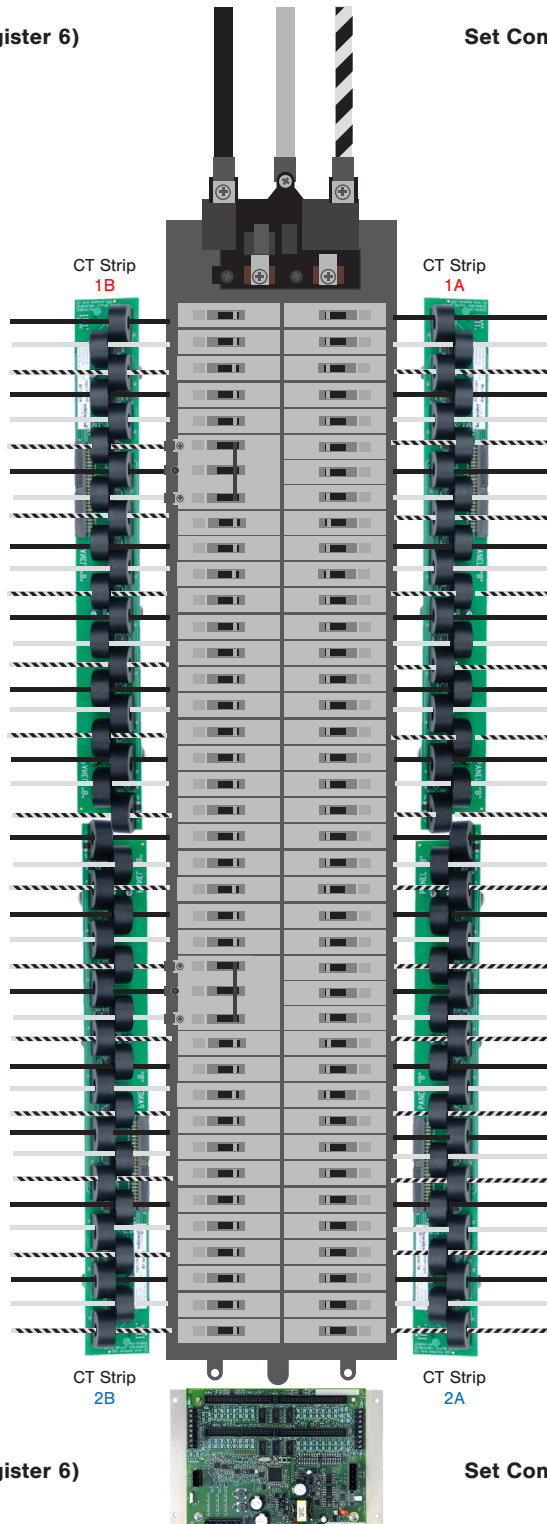

Appendix

#10

Top of Panels ↑

24/48-ch Top Feed Configuration Panel 1

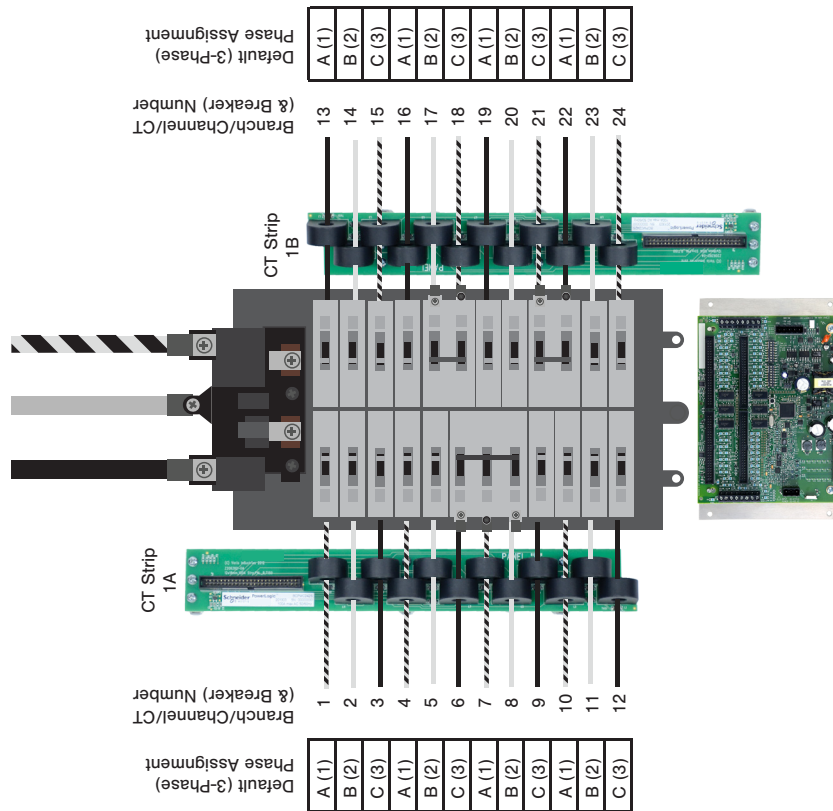

Panel 1
Set Configuration (Modbus Register 6) to Sequential (2)

48-ch Top Feed Configuration Panel 2

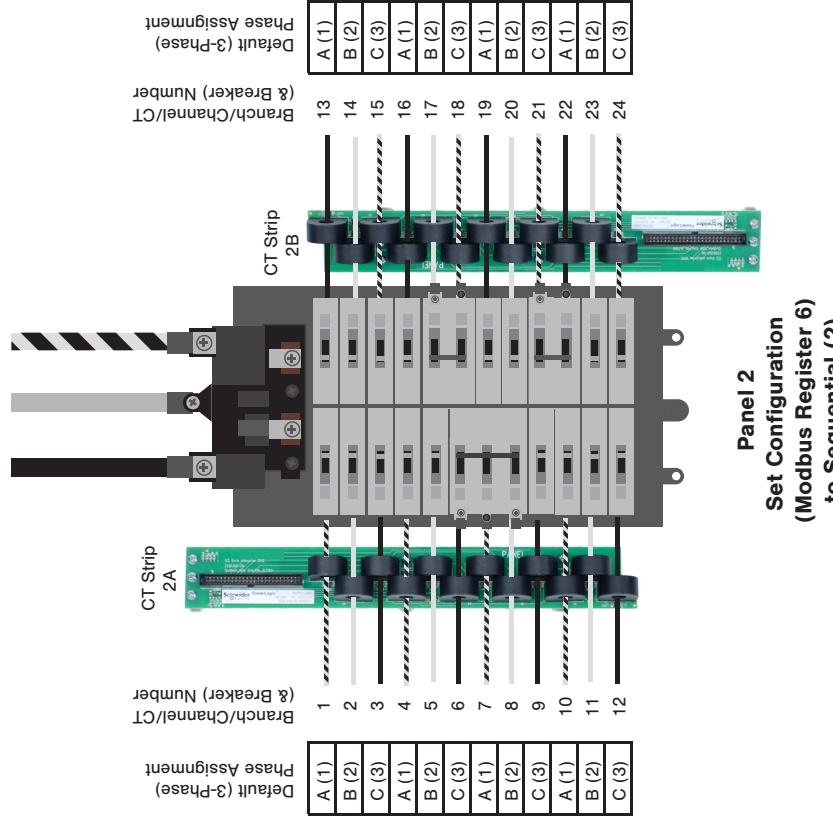

Panel 2
Set Configuration (Modbus Register 6) to Sequential (2)

Appendix

Top of Panels ↑

#11

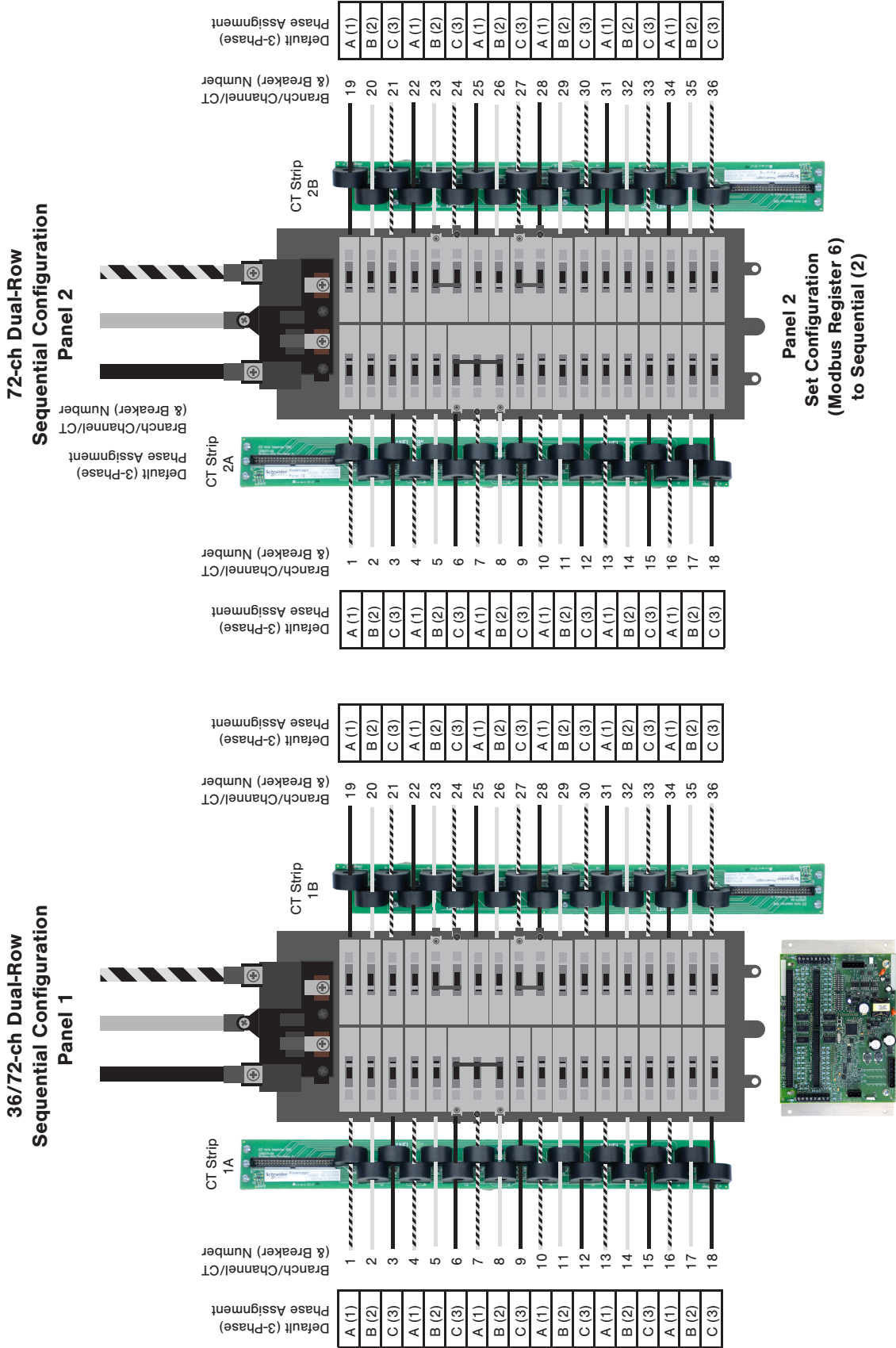

Appendix

Top of Panels ↑

#12

42/84-ch Bottom Feed Configuration Panel 1

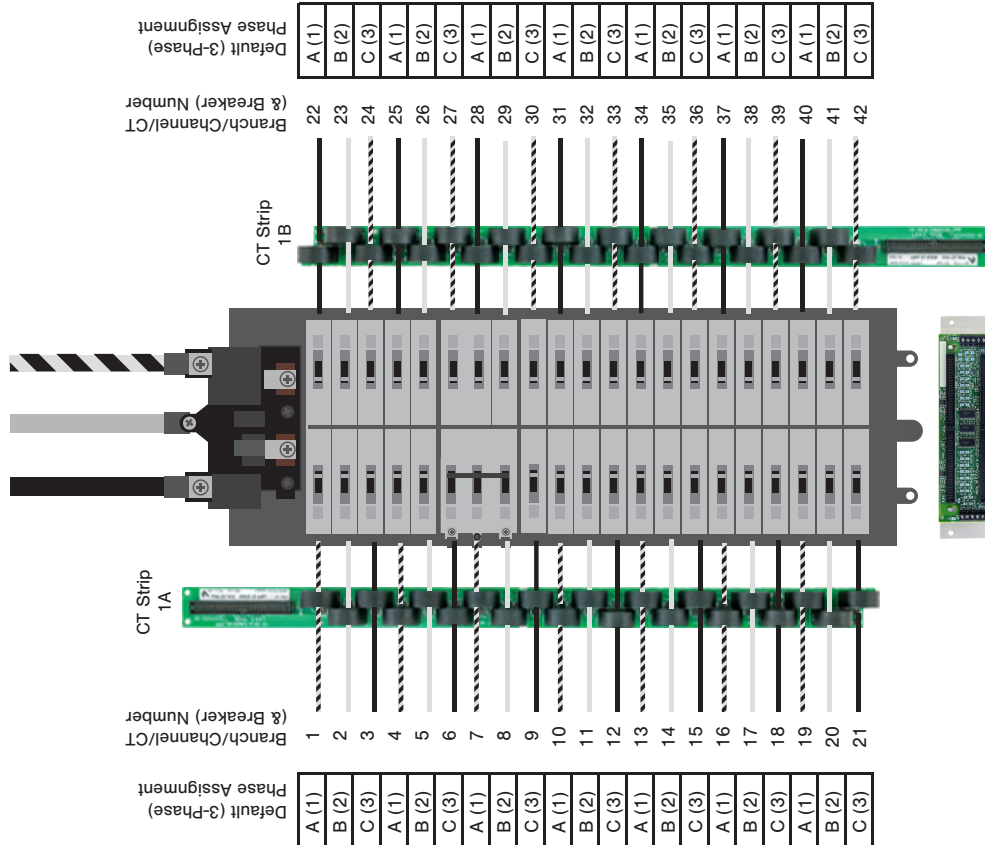

Panel 1 Set Configuration (Modbus Register 6) to Top (0)

84-ch Bottom Feed Configuration Panel 2

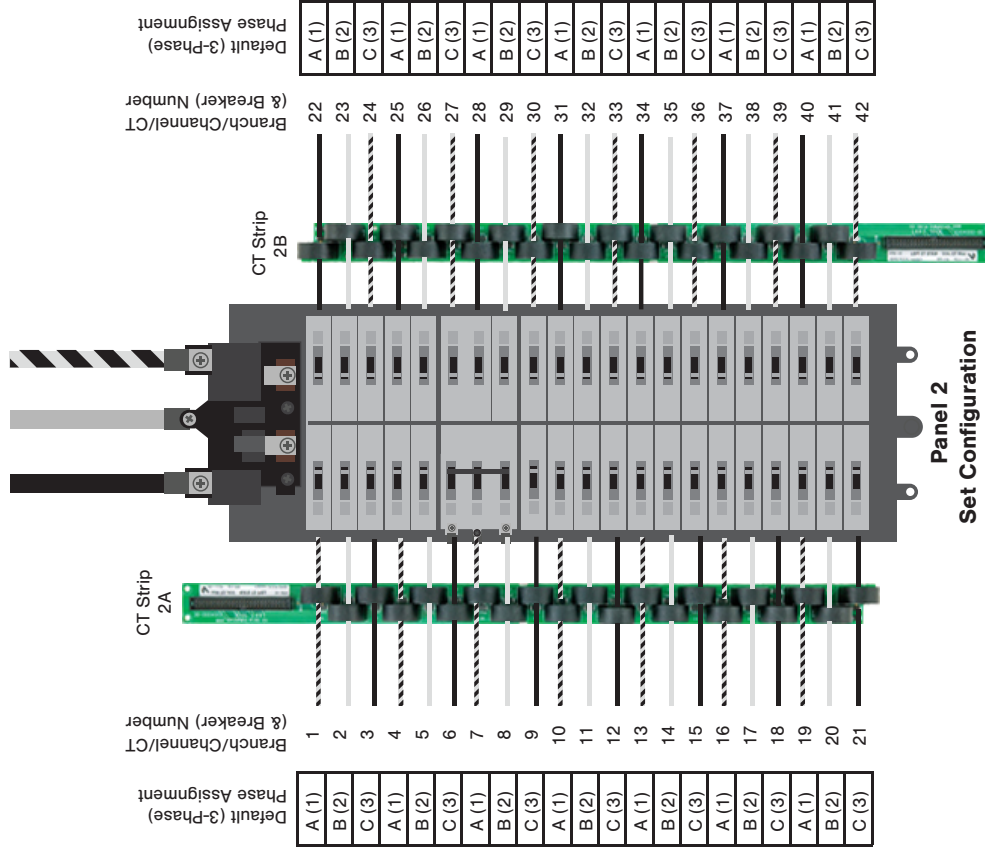

Panel 2 Set Configuration (Modbus Register 6) to Top (0)

Appendix

#13

48-ch Dual-Row Large Panel Sequential Configuration Panel 1

48-ch Dual-Row Large Panel Sequential Configuration Panel 2

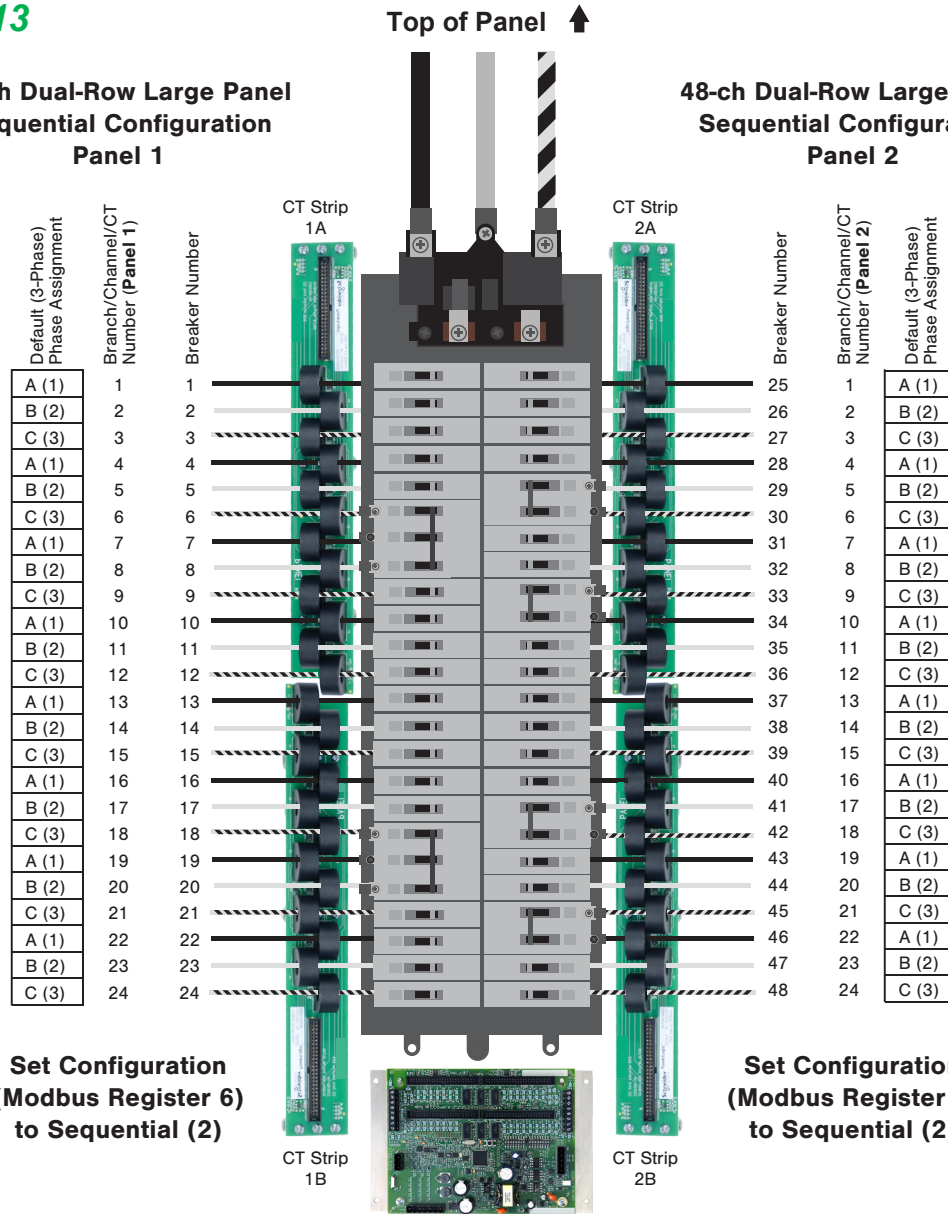

Appendix #14

Top of Panels ↑

72-ch Dual-Row Large Panel
Sequential Configuration
Panel 1

72-ch Dual-Row Large Panel
Sequential Configuration
Panel 2

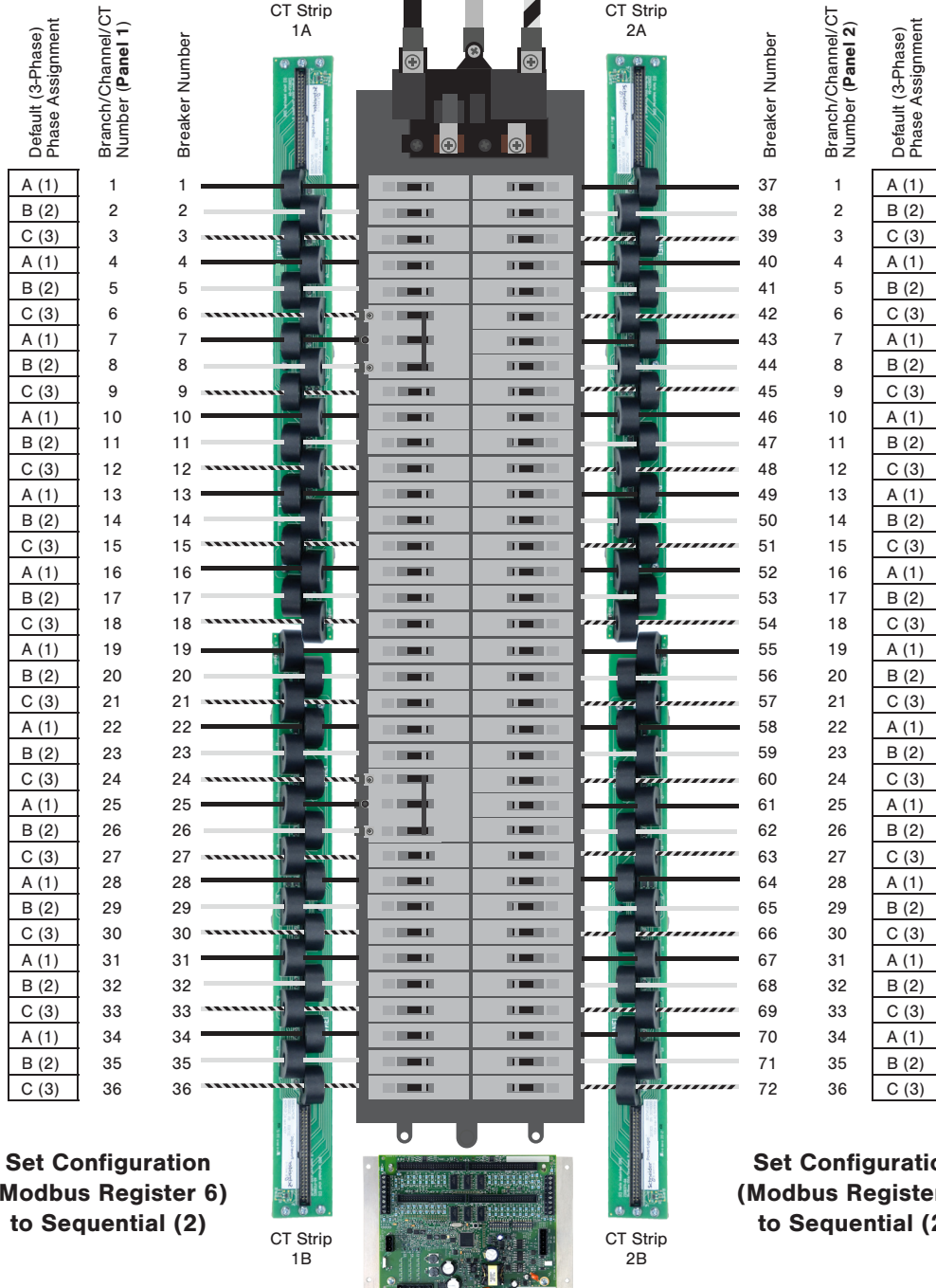

Appendix #15

Top of Panel ↑

84-ch Dual-Row Large Panel
Sequential Configuration
Panel 1

84-ch Dual-Row Large Panel
Sequential Configuration
Panel 2

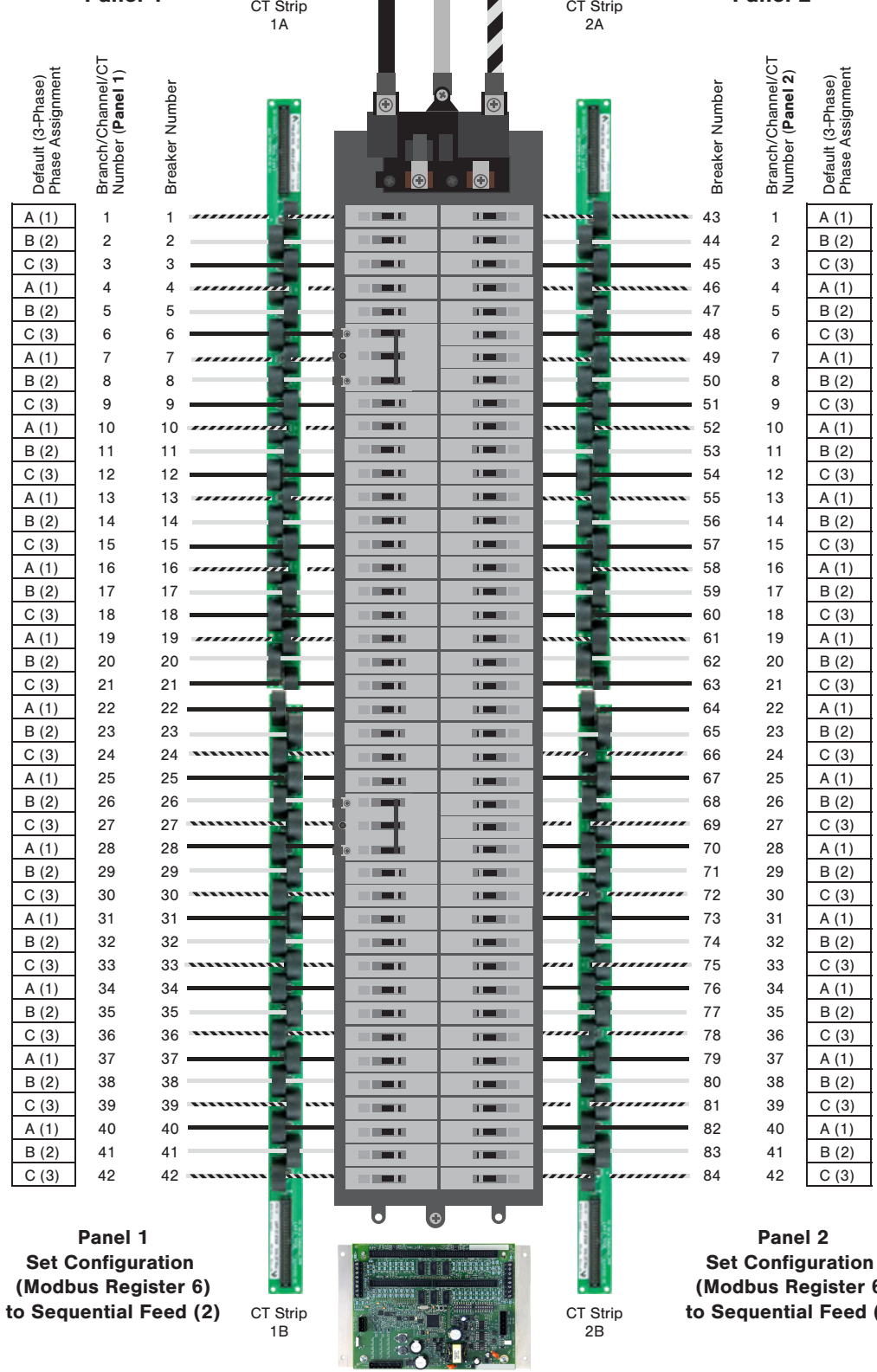

Panel 1
Set Configuration
(Modbus Register 6)
to Sequential Feed (2)

Panel 2
Set Configuration
(Modbus Register 6)
to Sequential Feed (2)

Appendix

#16

Top of Panel ↑

24-ch Single-Row
Sequential Configuration

Set Configuration
(Modbus Register 6)
to Sequential (2)

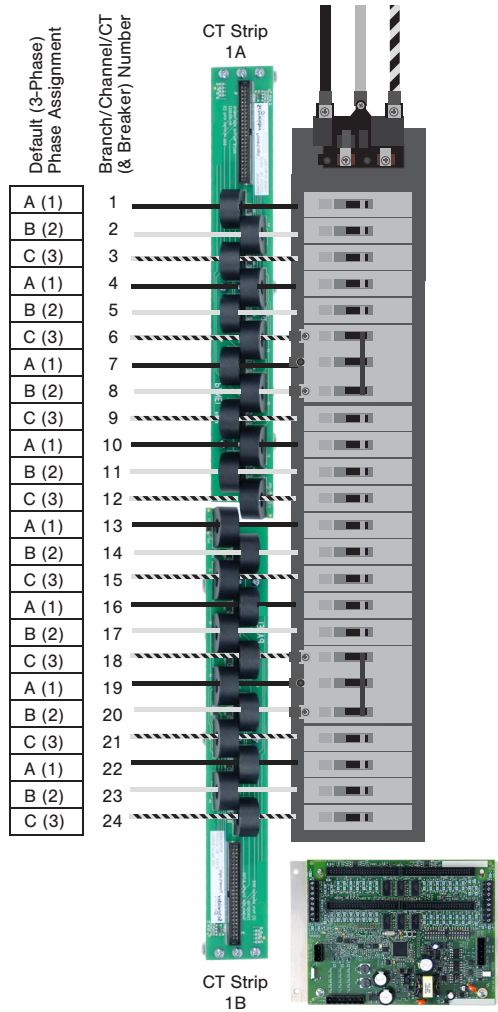

Appendix

#17

Top of Panel ↑

**36-ch Single-Row
Sequential Configuration**

**Set Configuration
(Modbus Register 6)
to Sequential (2)**

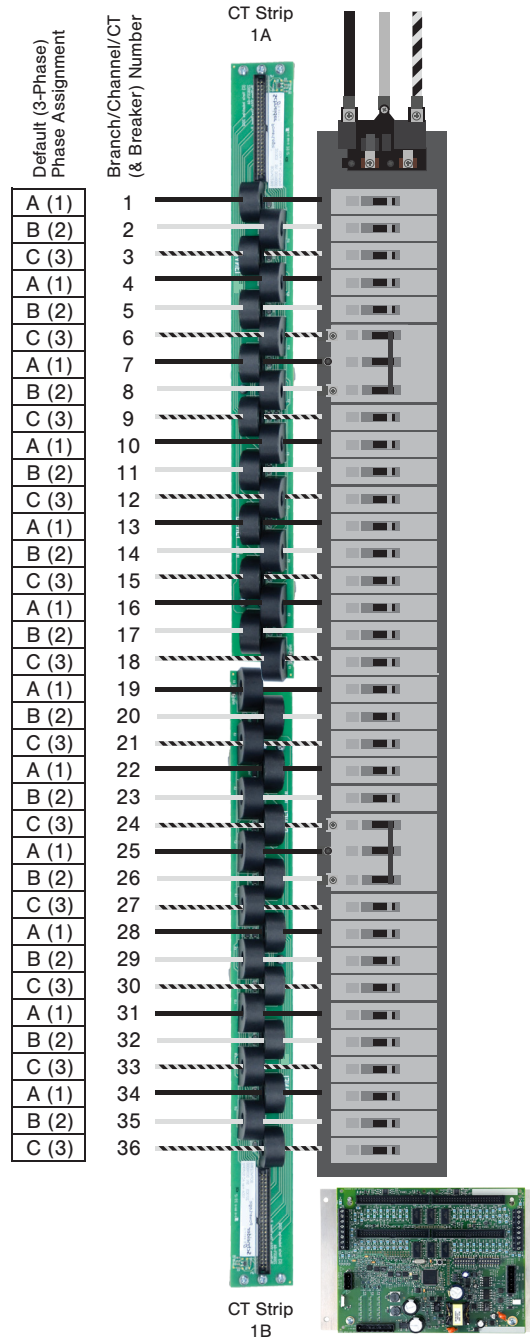

Appendix

#18

Top of Panel ↑

42-ch Single-Row
Sequential Configuration

Set Configuration
(Modbus Register 6)
to Sequential (2)

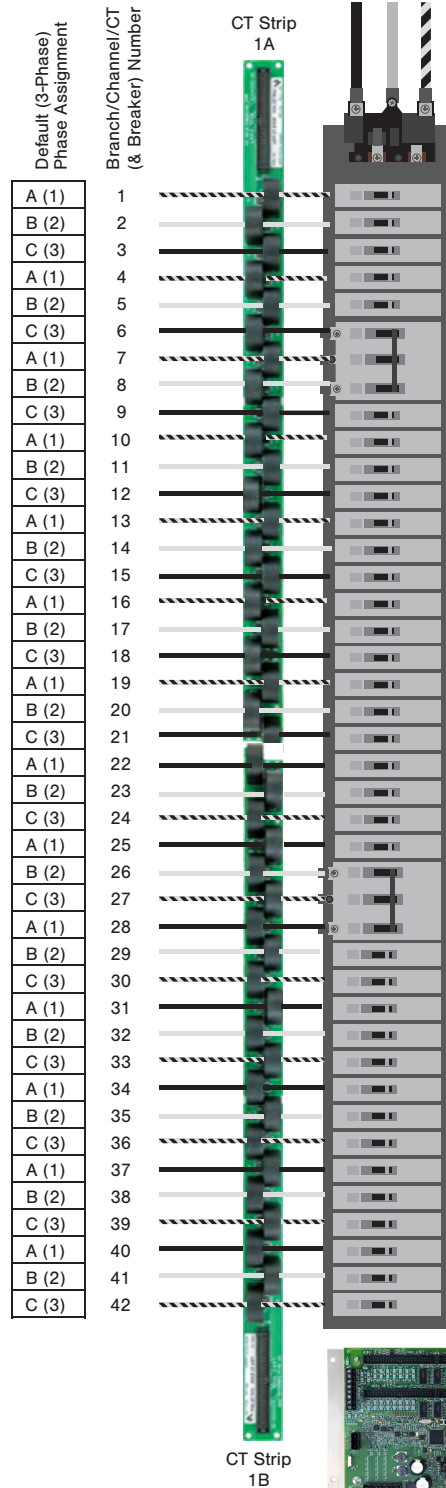

Appendix

#19

Top of Panel ↑

42-ch Odd/Even Configuration

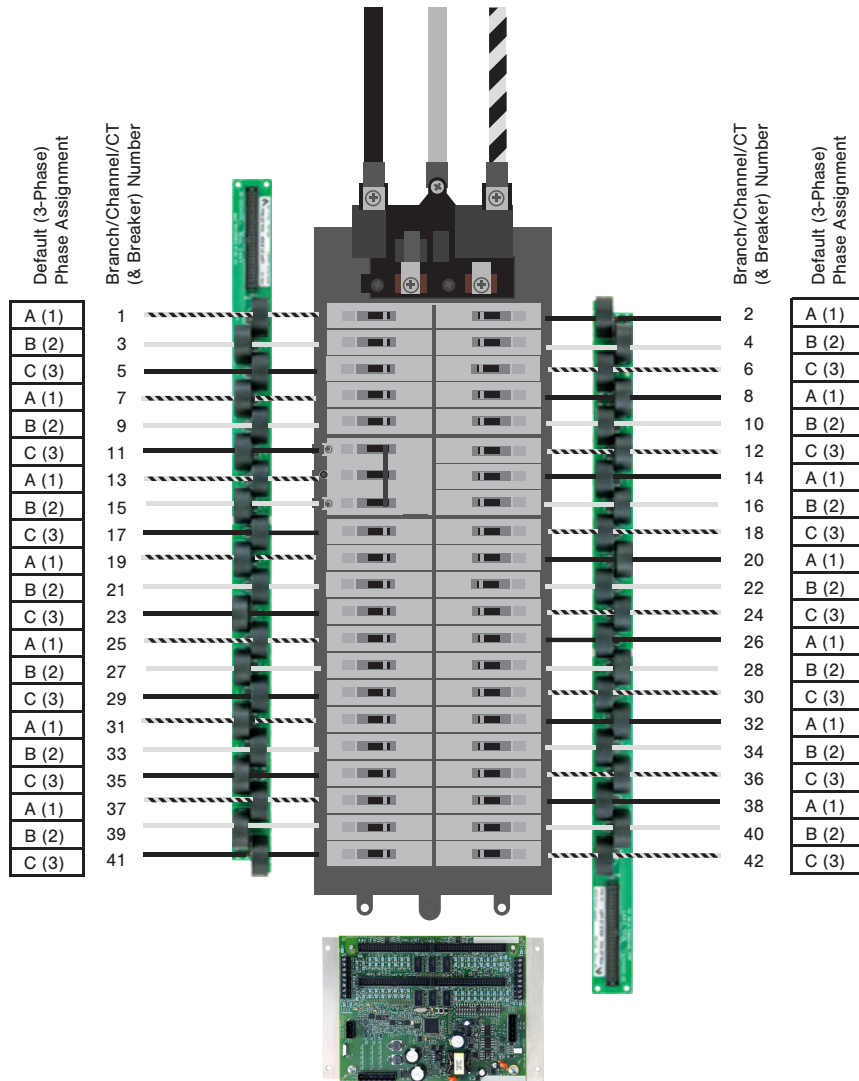

Panel 1
Set Configuration
(Modbus Register 6)
to Odd/Even (3)

Appendix

#20

Top of Panel ↑

24-ch Sequential Configuration

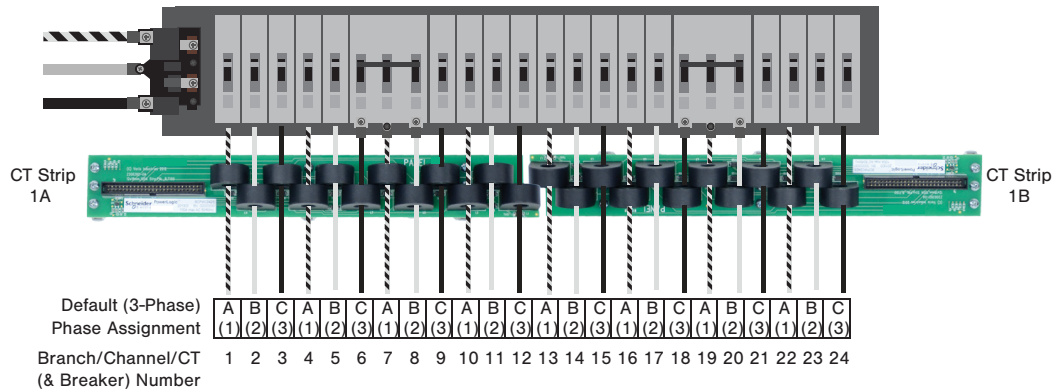
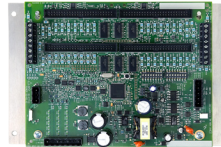

Panel 1
Set Configuration
(Modbus Register 6)
to Sequential (2)

Appendix

#21

Top of Panel ↑

36-ch Sequential Configuration

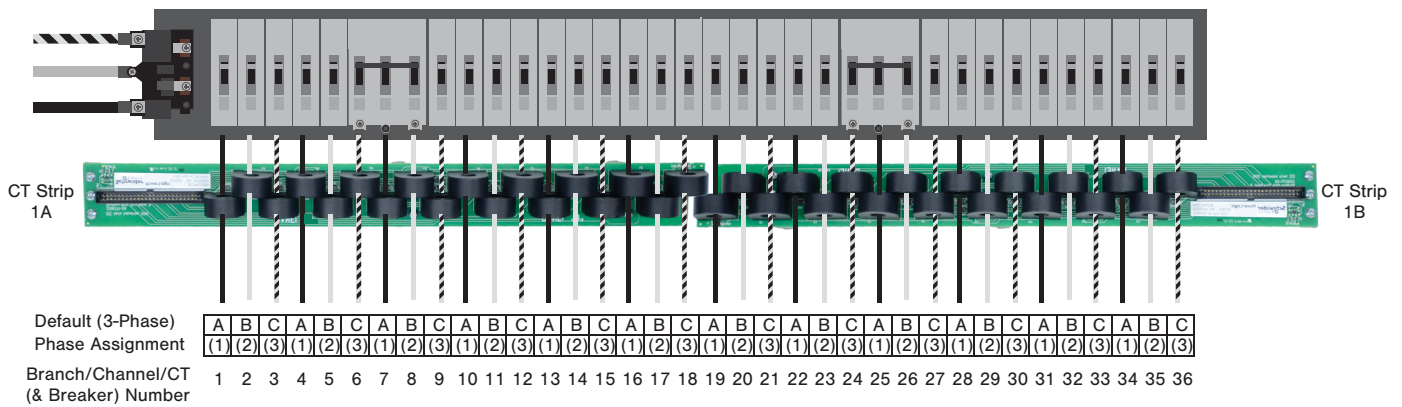
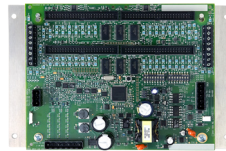

Panel 1
Set Configuration
(Modbus Register 6)
to Sequential (2)

Appendix

#22

Top of Panel ↑

42-ch Sequential Configuration

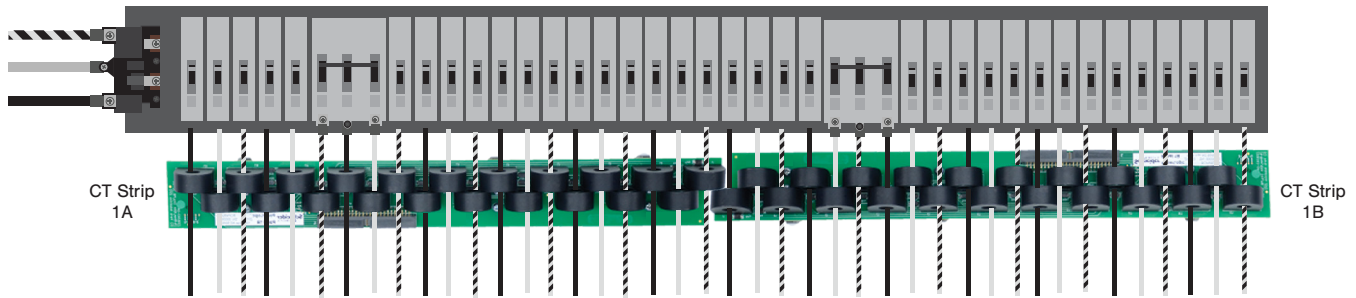
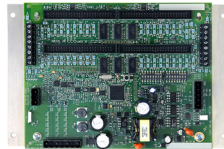

Default (3-Phase)	A	B	C	A	B	C	A	B	C	A	B	C	A	B	C	A	B	C	A	B	C	A	B	C	A	B	C	A	B	C	A	B	C	A	B	C	A	B	C			
Phase Assignment	(1)	(2)	(3)	(1)	(2)	(3)	(1)	(2)	(3)	(1)	(2)	(3)	(1)	(2)	(3)	(1)	(2)	(3)	(1)	(2)	(3)	(1)	(2)	(3)	(1)	(2)	(3)	(1)	(2)	(3)	(1)	(2)	(3)	(1)	(2)	(3)	(1)	(2)	(3)			
Branch/Channel/CT (& Breaker) Number	1	2	3	4	5	6	7	8	9	10	11	12	13	14	15	16	17	18	19	20	21	22	23	24	25	26	27	28	29	30	31	32	33	34	35	36	37	38	39	40	41	42

Panel 1
Set Configuration
(Modbus Register 6)
to Sequential (2)

Appendix

#23

Top of Panels ↑

24-ch Dual-Row Sequential Configuration

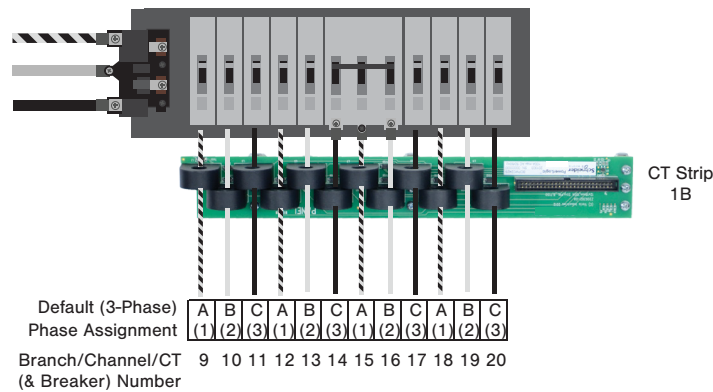
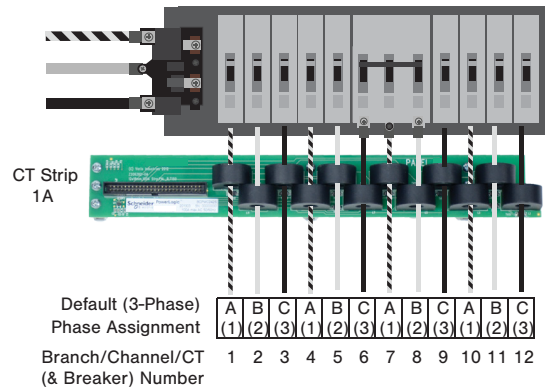
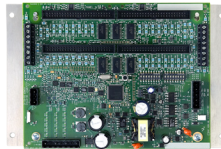

Panel 1 Set Configuration (Modbus Register 6) to Sequential (2)

Appendix

#24

Top of Panels ↑

36-ch Dual-Row Sequential Configuration

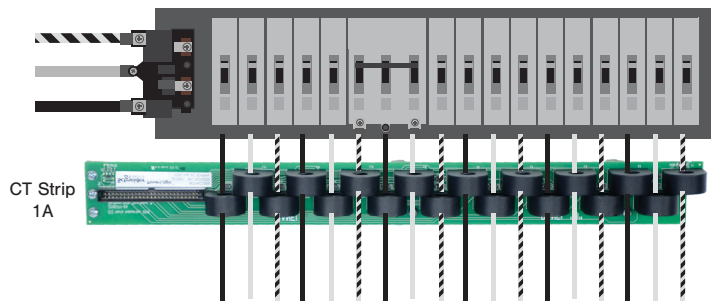
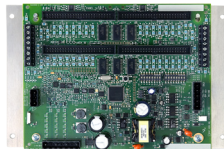

Default (3-Phase)	A	B	C	A	B	C	A	B	C	A	B	C	A	B	C	A	B	C
Phase Assignment	(1)	(2)	(3)	(1)	(2)	(3)	(1)	(2)	(3)	(1)	(2)	(3)	(1)	(2)	(3)	(1)	(2)	(3)
Branch/Channel/CT (& Breaker) Number	1	2	3	4	5	6	7	8	9	10	11	12	13	14	15	16	17	18

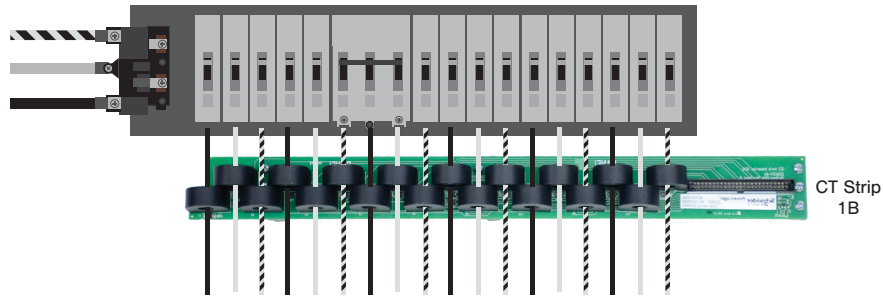

Default (3-Phase)	A	B	C	A	B	C	A	B	C	A	B	C	A	B	C	A	B	C
Phase Assignment	(1)	(2)	(3)	(1)	(2)	(3)	(1)	(2)	(3)	(1)	(2)	(3)	(1)	(2)	(3)	(1)	(2)	(3)
Branch/Channel/CT (& Breaker) Number	19	20	21	22	23	24	25	26	27	28	29	30	31	32	33	34	35	36

Panel 1 Set Configuration (Modbus Register 6) to Sequential (2)

Appendix

#25

Top of Panels ↑

42-ch Dual-Row Sequential Configuration

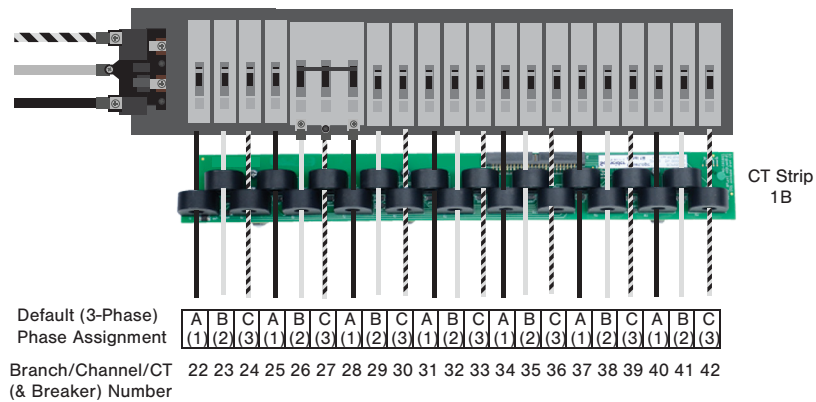
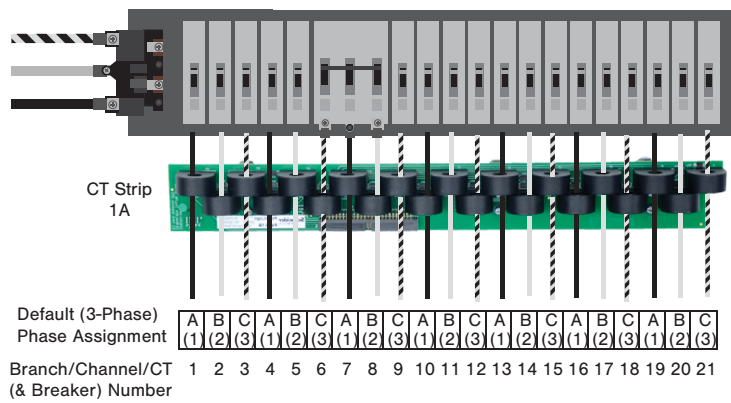
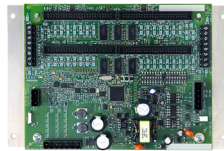

Panel 1
Set Configuration
(Modbus Register 6)
to Sequential (2)

Appendix

#26

Top of Panels ↑

48-ch Dual-Row Sequential Configuration

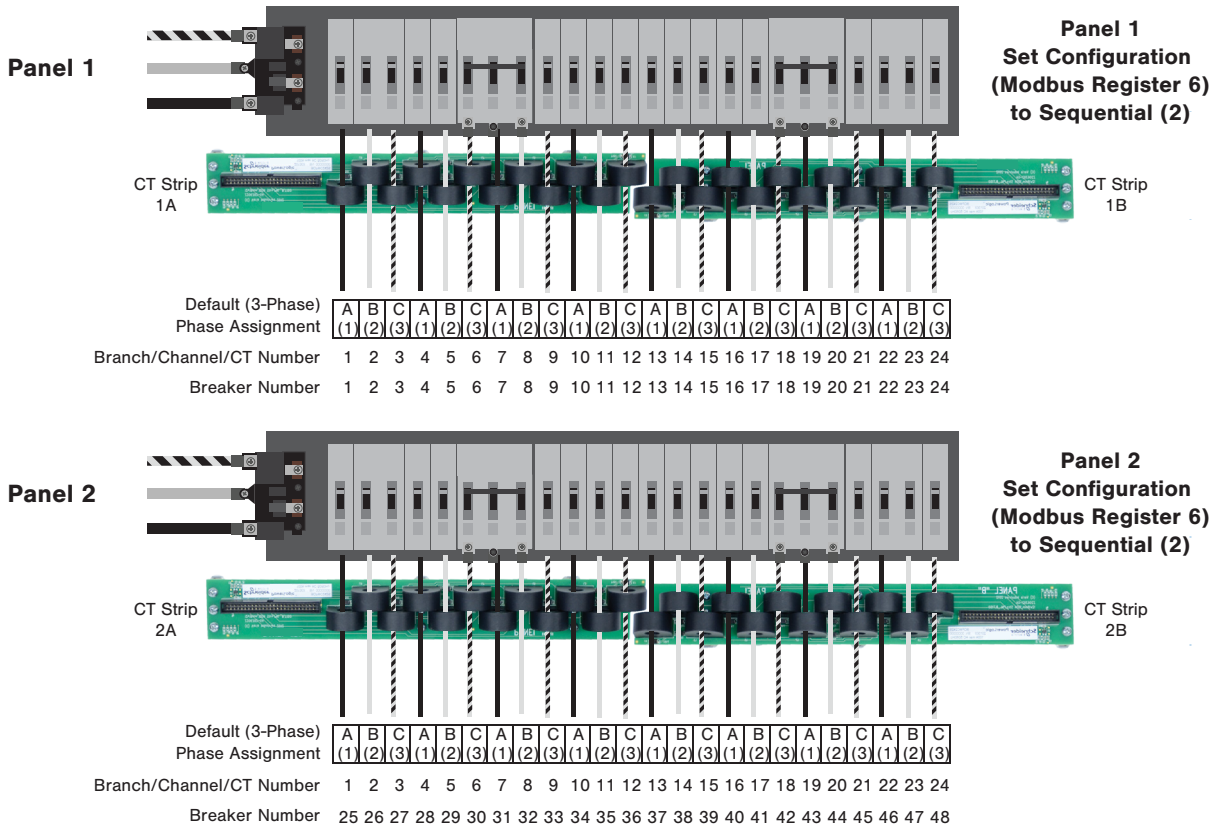
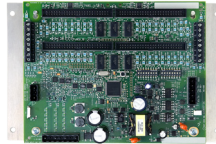

Appendix

#27

Top of Panels ↑

72-ch Dual-Row Sequential Configuration

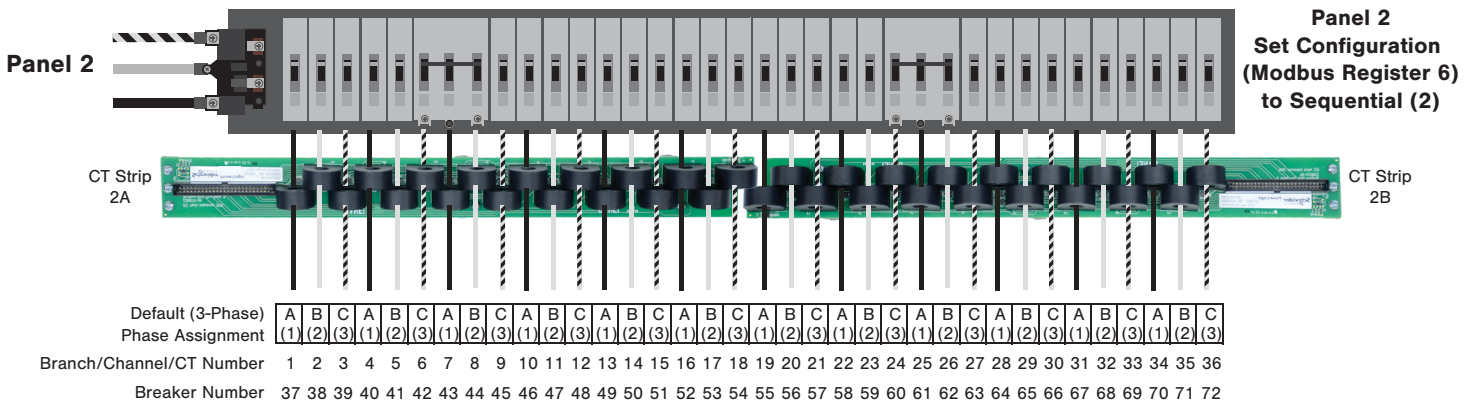
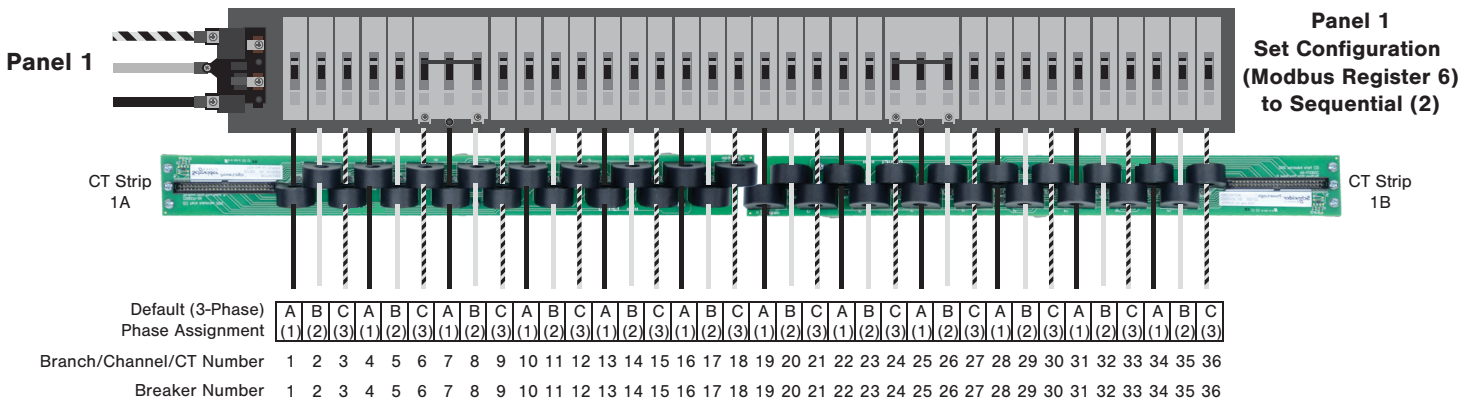
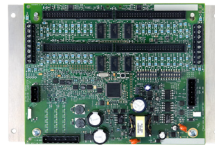

Appendix

#28

Top of Panels ↑

84-ch Dual-Row Sequential Configuration

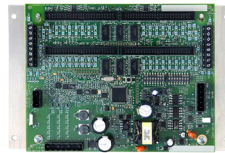

Panel 1
Set Configuration
(Modbus Register 6)
to Sequential (2)

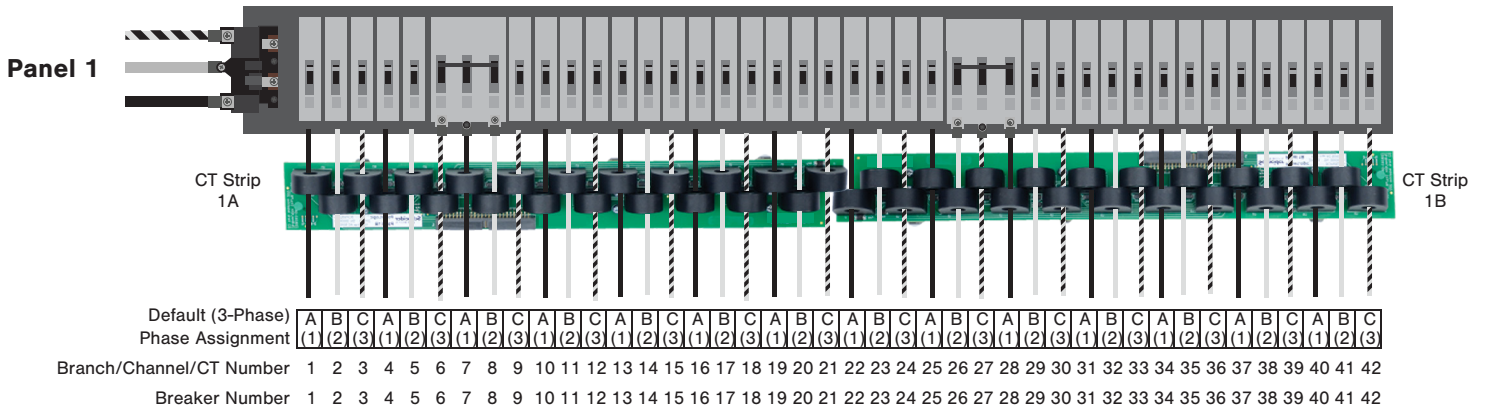

Panel 2
Set Configuration
(Modbus Register 6)
to Sequential (2)

