

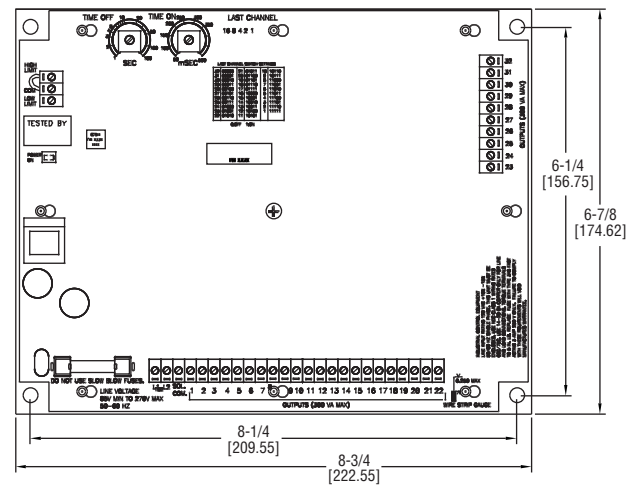

Specifications – Installation & Operating Instructions

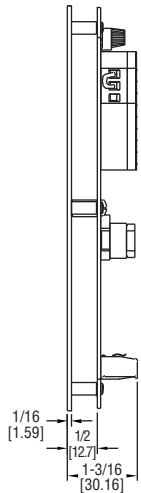
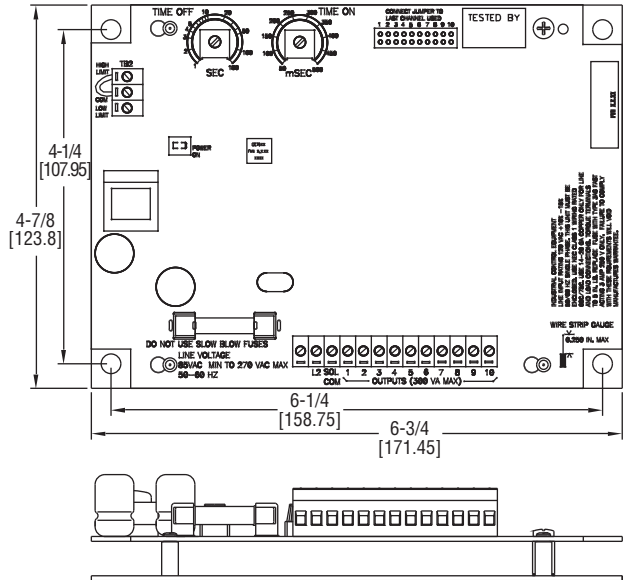
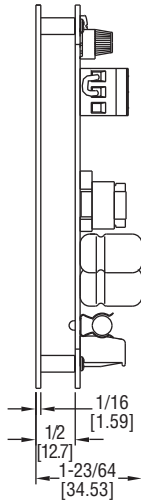
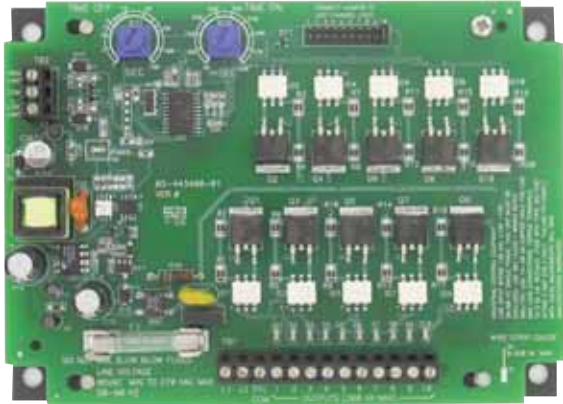

Introduction

The Series DCT600 Timer Controller is a timing system for pulse-jet type dust collectors or pneumatic conveying systems in either continuous or on-demand cleaning applications. It provides either 4, 6, 10, 22 or 32 channels. The DCT600 was designed for ease of installation in your dust collector system. For installations requiring fewer channels than available on the board, a shorting plug (DCT610) or dip switches (DCT632) allows selection of the last used channel. Time-on and time-off settings are selected using two potentiometers. High-limit and low-limit control inputs are provided for use with on-demand systems. When used in a continuous mode the high-limit input is jumpered. For safety, the control circuitry including the control inputs and the last channel jumper, is isolated from the power line.

SPECIFICATIONS

- Output Channels:** 4, 6, 10, 22 & 32 channels.
- Voltage Requirements:** 85 to 270 VAC (~) 50 or 60 Hz.
- Power Consumption:** 1.8 W.
- Input Power:** 302 VA max.
- Load:** 300 VA max, pilot rating C300.
- Fuse:** Type 3 AG, 3A @ 250 VAC (~).
- Ambient Operation Temperature:** -40 to 149°F (-40 to 65°C).
- Storage Temperature:** -40 to 176°F (-40 to 80°C).
- Humidity Conditions:** 5 to 95% noncondensing.
- On Time:** 50 to 500 msec.
- On Time Accuracy:** ±5% of setting.
- On Time Repeatability:** ±1 msec.
- Off Time:** 1 to 180 seconds.
- Off Time Accuracy:** 5% of setting.
- Pollution Degree:** 2.
- Altitude:** 6560 ft (2000 m) max.
- Environment:** Indoor use, must be installed in a weather-proof enclosure for outside applications.
- Weight:** 9 oz (255 g).
- Agency Approvals:** UL, cUL, CE.

Installation



Warning: Always install and service this device with the power off and a lockout installed if required. Line voltages are exposed on the board. As a result, this device is not intended to be installed in any open location. It must be installed within an enclosure that meets appropriate safety and local code requirements. Follow applicable safety procedures when installing or servicing this product.



Warning: Always replace the fuse with the proper type and rating. The fuse is Type 3 AG fast acting 3 Amp @ 250V. DO NOT use slow-blow type fuses. Failure to comply with this requirement will pose a serious safety risk and will void manufacturer's warranty.



As a permanently installed piece of equipment, a power disconnect switch, circuit breaker, or other approved disconnect device must be installed in close proximity to the installed board and within easy reach of the operator. This disconnect device must include a label indicating its function as a mains disconnect.

Power Requirements

The controller is designed for operation on either 120 VAC or 240 VAC 50/60 Hz power. The input voltage must be between 85 VAC and 270 VAC either 50 or 60 Hz. The solenoid loads must be rated for the line voltage.

Location

The system must be located in an enclosure that meets relevant safety standards and electrical codes. There are no other special orientation requirements. Mount it using the four mounting holes in the baseplate. The baseplate back is flush, so no special spacers are needed to accommodate obstructions except for those imposed by the location itself.

Installed screws and other mounting hardware must maintain a spacing of 0.250 in (6.35 mm) from the circuit board.

Connections

The line and solenoid connections are located at the lower edge of the board. The terminal block is a "Euro" style connector system that clamps the wire within the connector body. The connector will accept wire sizes from 14 to 22 gages. Wire must be copper only with at least 60°C or 60/75°C rated insulation. These terminals should be torqued to 5 in. lb. The connectors are specified for single connection but multiple wires may be connected to a single lug provided local codes allow this and good workmanship practices are followed. When using stranded wire, make sure that there are no "stray" strands. These pose safety hazards and may cause system failure or damage. Connect the line power to L1 and L2. Connect the solenoids between the selected output and the solenoid common. Solenoid common and L2 are internally connected. Refer to Figure 2-1 or Figure 2-2 depending on model.

The wire should be stripped to no more than 0.25 in. A strip gauge is provided at the lower right corner of the board. Longer than this may cause shorts or expose line voltages to possible contact.

Switches connected to the control inputs at the top of the board must be isolated normally open contacts connected only to the relevant terminal and to the common terminals. These switches should be rated for low voltage and low current operation.

The following subparagraphs describe the external switch connections. Refer to figure 2-1 or Figure 2-2 depending on model for switch connection illustration.

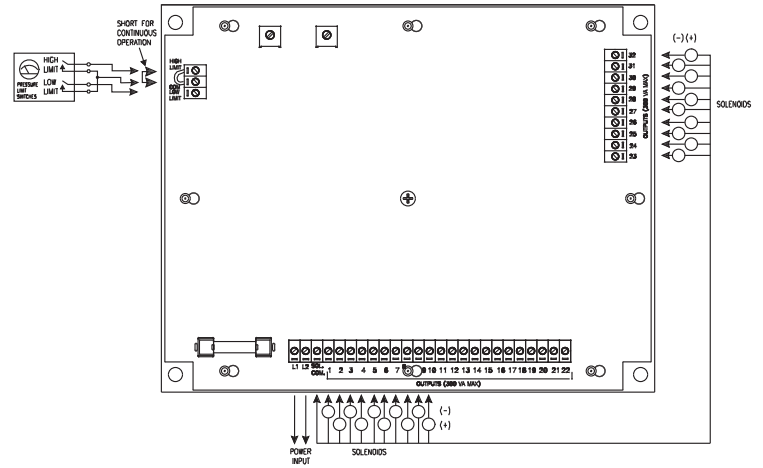

Figure 2-1 Wiring Connections DCT622, DCT632

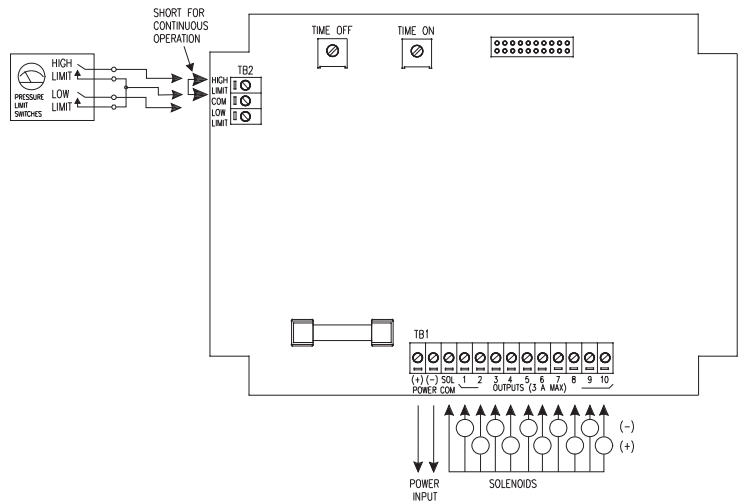

Figure 2-2 Wiring Connections DCT604, DCT606, DCT610

External Limit Switch Connection

The controller may be used with an external pressure limit switch or sensor to provide demand-cleaning operation. A three pin terminal block provides connection for external high and low limit switches. A simple on-off system can be established with a single pressure switch connected to the high limit input. Better control can be achieved with a high and low limit switch/gage such as the Dwyer Photohelic® pressure gage. The switches must be isolated contacts between the high or low limit input and the common connection. The wiring from the switches must be two or three wires with no other connections made to these. The common line must not be connected to equipment ground or protective ground, since these may introduce electrical noise and cause improper operation or possible damage to the control board. The operation of these inputs is summarized as follows:

Operating Modes

Current Operation	Low Limit Switch	High Limit Switch	Next Operation
Hold	Open	Open	Hold
Hold or Run	X	Closed	Run
Hold	∅	Open	Hold
Hold	Closed	∅	Run
Run	Closed	≠	Run
Hold	Closed	∅	Run
Run	≠	Open	Hold

∅ – Transition from open to closed
 ≠ – Transition closed to open
 X – Either open or closed

Continuous Cycle Mode

The DCT600 has two operating modes available for different applications. Starting with the most basic mode, it is capable of operating in a continuous cleaning cycle. This can be initiated by placing a jumper between the high limit input and the common connection. Two setup parameters control operation: time off, time on. Time on and time off specifically deal with the solenoid on time and the time interval between the end of the on pulse and the start of the next.

Demand Mode

Demand mode operation can be configured using the high limit and low limit inputs. A simple on-off system can be setup with a single pressure switch connected to the high limit input. Better control can be achieved with a high and low limit switch set such as is provided in the Photohelic® pressure gage. In this on-demand mode, time on and time off may be programmed to define the cleaning cycle. When the cleaning cycle is completed, the controller will continue the cycle until the last channel is pulsed. The next cleaning cycle will always start on channel 1. A factory installed option is available. A factory installed option is available that will not clean to the end of a cycle, but rather stop where the cleaning cycle ended. The next demand for cleaning will start where the last cleaning cycle left off.

System Setup

Last Channel Selection DCT604, DCT606, DCT610

A jumper connector is provided on the DCT610, DCT606, and DCT604 to select the last channel used. Place the jumper on the two pins corresponding to the last channel used in the installation.

Last Channel Selection DCT622, DCT632

The DCT622 and DCT632 use a set of 5 switches to select the last channel. If the selected last channel is greater than the number of channels available then the controller will cycle through only the available channels. The following table defines the switch settings for each of the last channel selections. For convenience this table is also provided on the board below the switch.

Time Off and Time On Setup

Channel	Switch	Channel	Switch	Channel	Switch
32	00000	21	01011	10	10110
31	00001	20	01100	9	10111
30	00010	19	01101	8	11000
29	00011	18	01110	7	11001
28	00100	17	01111	6	11010
27	00101	16	10000	5	11011
26	00110	15	10001	4	11100
25	00111	14	10010	3	11101
24	01000	13	10011	2	11110
23	01001	12	10100	1	11111
22	01010	11	10101		

0 = Off, 1 = On

Time off defines the period of time between solenoid activations when no channels are enabled. This value may be set between 1 second and 200 seconds with a resolution of 1 second. Time on defines the solenoid on time. The value may be set between 50 msec and 500 msec with a resolution of 10 msec. If adjustments are made while the system is in operation, the new setting will take effect in the following solenoid cycle. Do not use excessive force to turn the potentiometers. This will damage the unit. A factory installed option is available for a time on range of 0.05 to 10 seconds.

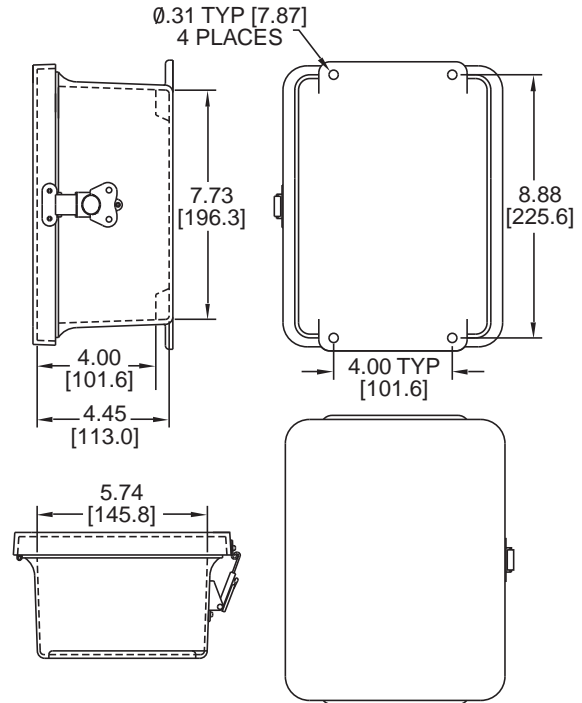

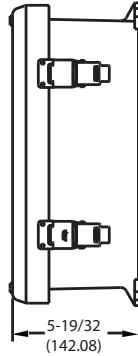
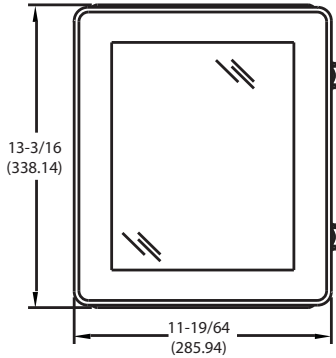
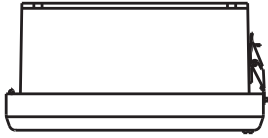

Weatherproof Enclosure Option
 DCT604, DCT606, DCT610



**Weatherproof Enclosure Option
DCT622, DCT632**

Explanation of Symbols:

Symbol	Description
	Caution: Risk of electric shock
	Caution: Risk of danger, refer to user's manual for further information
	Alternating current

Agency Approvals and Test Standards:

- UL: UL508: 2008
 IEC 61010-1: 2001-02
- CE: IEC 61000-4-2: 2001
 IEC 61000-4-3: 2006
 IEC 61000-4-4: 2004
 IEC 61000-4-5: 2005
 IEC 61000-4-6: 2006
 IEC 61000-4-11: 2004
 CENELEC EN 55022: 2007
 FCC Part 15 CFR Title 47: 2007
 ICES-003: 2004 Digital Apparatus (Industry Canada)
 ANSI 63.4-2003
 CENELEC EN 61326-1: 2006
 2004/108/EC EMC Directive