Digital Controller
CB100/CB400
CB500/CB700
CB900

[Z-1021]

MODBUS
Communication
Instruction Manual

- Modbus is a registered trademark of Schneider Electric.
- Company names and product names used in this manual are the trademarks or registered trademarks of the respective companies.

Thank you for purchasing the RKC instrument. In order to achieve maximum performance and ensure proper operation of your new instrument, carefully read all the instructions in this manual. Please place this manual in a convenient location for easy reference.

SYMBOLS

WARNING : This mark indicates precautions that must be taken if there is danger of electric shock, fire, etc., which could result in loss of life or injury.

CAUTION : This mark indicates that if these precautions and operating procedures are not taken, damage to the instrument may result.



: This mark indicates that all precautions should be taken for safe usage.



: This mark indicates important information on installation, handling and operating procedures.



: This mark indicates supplemental information on installation, handling and operating procedures.



: This mark indicates where additional information may be located.



WARNING

- An external protection device must be installed if failure of this instrument could result in damage to the instrument, equipment or injury to personnel.
- All wiring must be completed before power is turned on to prevent electric shock, fire or damage to instrument and equipment.
- This instrument must be used in accordance with the specifications to prevent fire or damage to instrument and equipment.
- This instrument is not intended for use in locations subject to flammable or explosive gases.
- Do not touch high-voltage connections such as power supply terminals, etc. to avoid electric shock.
- RKC is not responsible if this instrument is repaired, modified or disassembled by other than factory-approved personnel. Malfunction can occur and warranty is void under these conditions.

CAUTION

- This is a Class A instrument. In a domestic environment, this instrument may cause radio interference, in which case the user may be required to take adequate measures.
- This instrument is protected from electric shock by reinforced insulation. Provide reinforced insulation between the wire for the input signal and the wires for instrument power supply, source of power and loads.
- This instrument is designed for installation in an enclosed instrumentation panel. All high-voltage connections such as power supply terminals must be enclosed in the instrumentation panel to avoid electric shock by operating personnel.
- All precautions described in this manual should be taken to avoid damage to the instrument or equipment.
- All wiring must be in accordance with local codes and regulations.
- To prevent instrument damage or failure, protect the power line and the input/output lines from high currents with a protection device such as fuse, circuit breaker, etc.
- Prevent metal fragments or lead wire scraps from falling inside instrument case to avoid electric shock, fire or malfunction.
- Tighten each terminal screw to the specified torque found in the manual to avoid electric shock, fire or malfunction.
- For proper operation of this instrument, provide adequate ventilation for heat dispensation.
- Do not connect wires to unused terminals as this will interfere with proper operation of the instrument.
- Turn off the power supply before cleaning the instrument.
- Do not use a volatile solvent such as paint thinner to clean the instrument. Deformation or discoloration will occur. Use a soft, dry cloth to remove stains from the instrument.
- To avoid damage to instrument display, do not rub with an abrasive material or push front panel with a hard object.

NOTICE

- This manual assumes that the reader has a fundamental knowledge of the principles of electricity, process control, computer technology and communications.
- The figures, diagrams and numeric values used in this manual are only for purpose of illustration.
- RKC is not responsible for any damage or injury that is caused as a result of using this instrument, instrument failure or indirect damage.
- Periodic maintenance is required for safe and proper operation of this instrument. Some components have a limited service life, or characteristics that change over time.
- Every effort has been made to ensure accuracy of all information contained herein. RKC makes no warranty expressed or implied, with respect to the accuracy of the information. The information in this manual is subject to change without prior notice.
- No portion of this document may be reprinted, modified, copied, transmitted, digitized, stored, processed or retrieved through any mechanical, electronic, optical or other means without prior written approval from RKC.

CONTENTS

	Page
1. OUTLINE	1
2. SPECIFICATIONS	2
3. WIRING.....	3
4. COMMUNICATION SETTINGS.....	6
4.1 Communication Setting Mode	6
4.2 Select Communication Parameters	7
4.3 Slave Address Setting	8
4.4 Communication Speed Setting	10
4.5 Data Configuration Setting	12
4.6 Interval Time Setting	14
4.7 RS-485 Send/Receive Process Timing	17
5. MODBUS PROTOCOL.....	18
5.1 Message Format	18
5.2 Function Code	19
5.3 Communication Mode	19
5.4 Slave Response	20
5.5 Calculating CRC-16.....	21
6. MESSAGE FORMAT.....	23
6.1 Read Holding Registers [03H]	23
6.2 Preset Single Registers [06H]	24
6.3 Diagnostics (loopback test) [08H].....	25



	Page
7. DATA CONFIGURATION.....	26
7.1 Data Configuration	26
7.2 Data Processing Precautions	27
7.3 Communication Data List	28
8. TROUBLESHOOTING	35

1. OUTLINE

This manual describes the specifications, wiring instructions and communication settings for **CB100/CB400/CB500/CB700/CB900 Z-1021** with Modbus communication protocol.

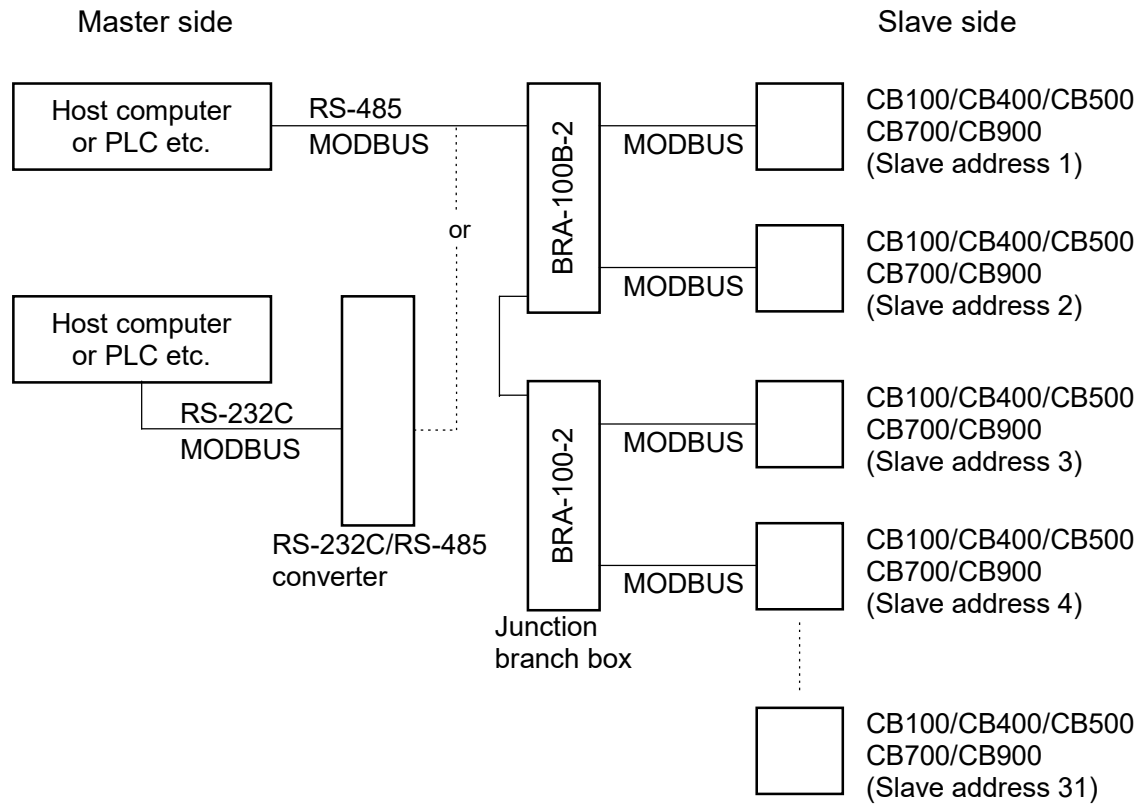

2. SPECIFICATIONS

- (1) **Interface:** Based on RS-485, EIA standard
- (2) **Connection method:** 2-wire system, half-duplex multi-drop connection
- (3) **Protocol:** Modbus
- (4) **Signal transmission mode:** Remote Terminal Unit (RTU) mode
- (5) **Synchronous method:** Start/stop synchronous type
- (6) **Communication speed:** 2400 bps, 4800 bps, 9600 bps, 19200 bps
(Selectable)
- (7) **Data type:** Data bit: 8 (Byte data corresponding to binary data or bit)
Parity check : Without, Odd or Even (Selectable)
Stop bit: 1
- (8) **Function codes:** 03H (Read holding registers)
06H (Preset single register)
08H Diagnostics (loopback test)
- (9) **Error check method:** CRC-16
- (10) **Error codes:** 1: Function code error
(Designation of an unsupported function code)
2: When written to *read only* data
When any address other than 0000H to 0019H is specified, etc.
3: When the data written exceeds the setting range
When the specified number of data items in the query message exceeds the maximum number of data items available
4: Self-diagnostic error response
- (11) **Maximum connection:** 32 instruments including a master

3. WIRING

WARNING

To prevent electric shock or instrument failure, turn off the power before connecting or disconnecting the instrument and peripheral equipment.

■ Terminal number and signal details

CB100/CB400/CB500/CB900

Terminal No.	Signal name	Name	Signal direction	
			Slave	Master
13	SG	Signal ground	—————	
14	T/R(A)	Send data/Receive data	←————→	
15	T/R(B)	Send data/Receive data	←————→	

CB700

Terminal No.	Signal name	Name	Signal direction	
			Slave	Master
7	SG	Signal ground	—————	
8	T/R(A)	Send data/Receive data	←————→	
9	T/R(B)	Send data/Receive data	←————→	

■ **Connection to the RS-485 port of the master**

The master has a built-in circuit to transfer send/receive data alternatively.

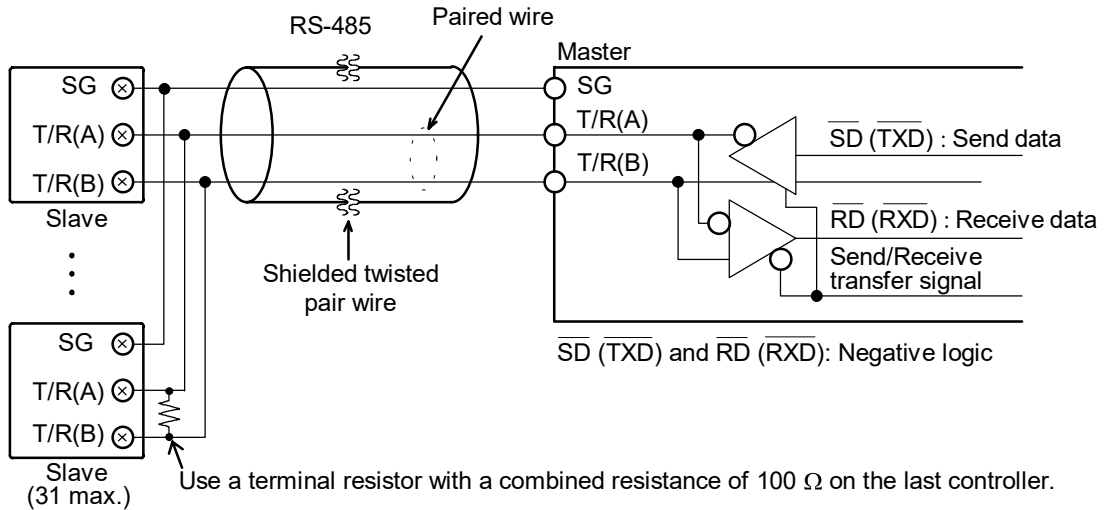

■ **Connection to the RS-232C port of the master**

A RS-232C/RS-485 communication converter is required.

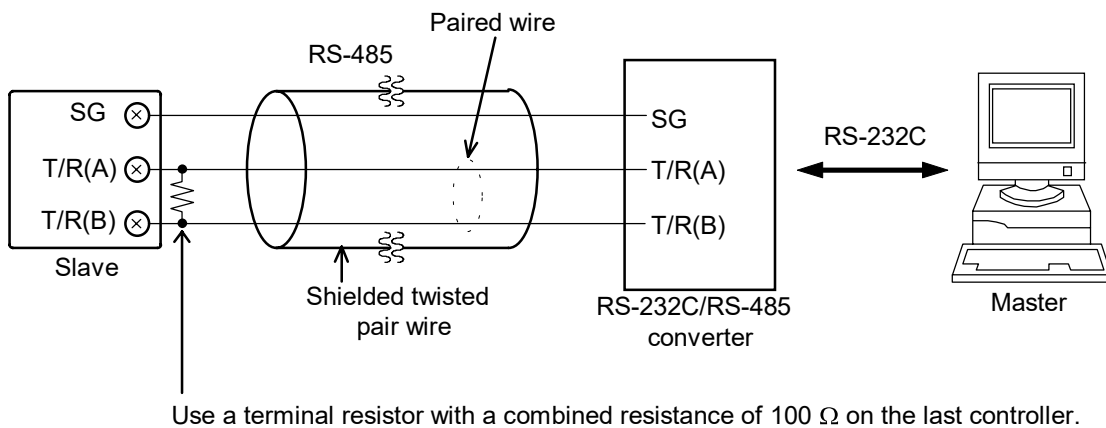

 When the master uses Windows 95/NT, use a RS-232C/RS-485 converter with an automatic send/receive transfer function.

Recommended: CD485, CD485/V manufactured by Data Link, Inc. or equivalent.

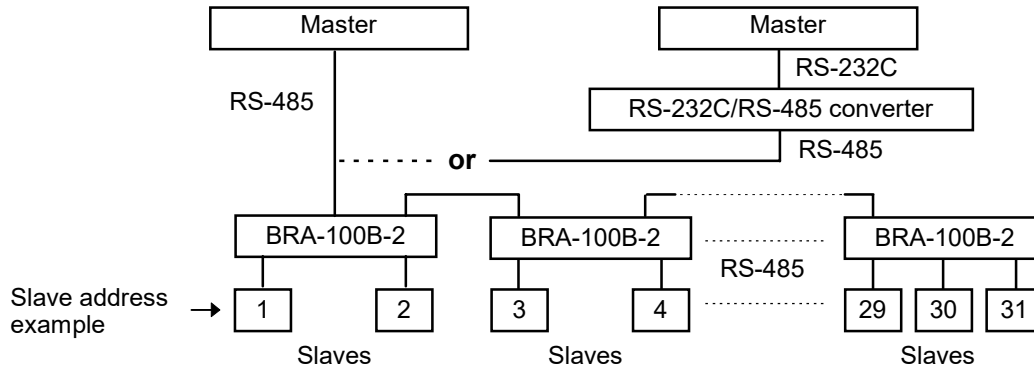
■ Connection with up to 31 slaves and one master

👉 For all pertinent details on the RS-232C/RS-485 converter and junction branch box (**BRA-100B-2**), see the respective instruction manuals.

4. COMMUNICATION SETTINGS

To establish communication parameters between master and slave, it is necessary to set the slave address, communication speed, data configuration and interval time on each slave in the communication mode.

The CB900 controller will be used as an example, but the same instructions apply to all CB Series controllers with Modbus protocol.

4.1 Communication Setting Mode

1. When the power to the instrument is turned on, the input type, input range and PV/SV display mode will be automatically displayed in that order.
2. To go to the communication setting mode, you must be in either PV/SV display mode or the SV setting mode. Press and hold the SET key and press the <R/S key at the same time to initiate communication settings. The first parameter to be displayed will be the slave address, *Add*.

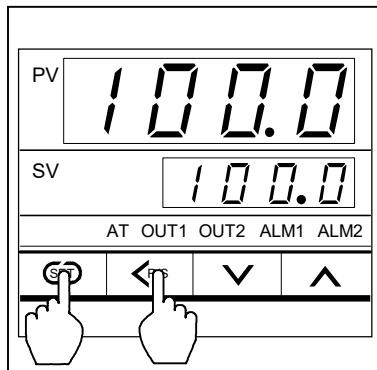

PV/SV display mode

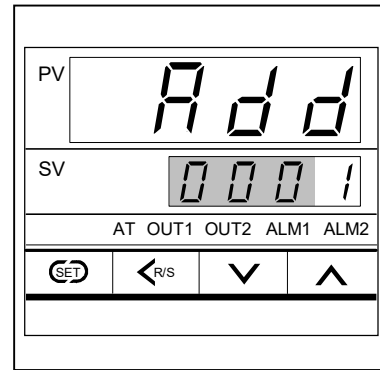

Communication setting mode
Add -Slave address setting

The number segment being set will be brighter than the others in the SV display

 To return to the PV/SV display mode, press and hold the SET key and press the <R/S key at the same time.

4.2 Select Communication Parameters

To select parameters in communication setting mode, press the SET key. The parameters are displayed and sequenced in the order of slave address, *Add*, communication speed, *bPS*, data configuration, *bIT* and interval time set value, *InT*.

■ Display flowchart

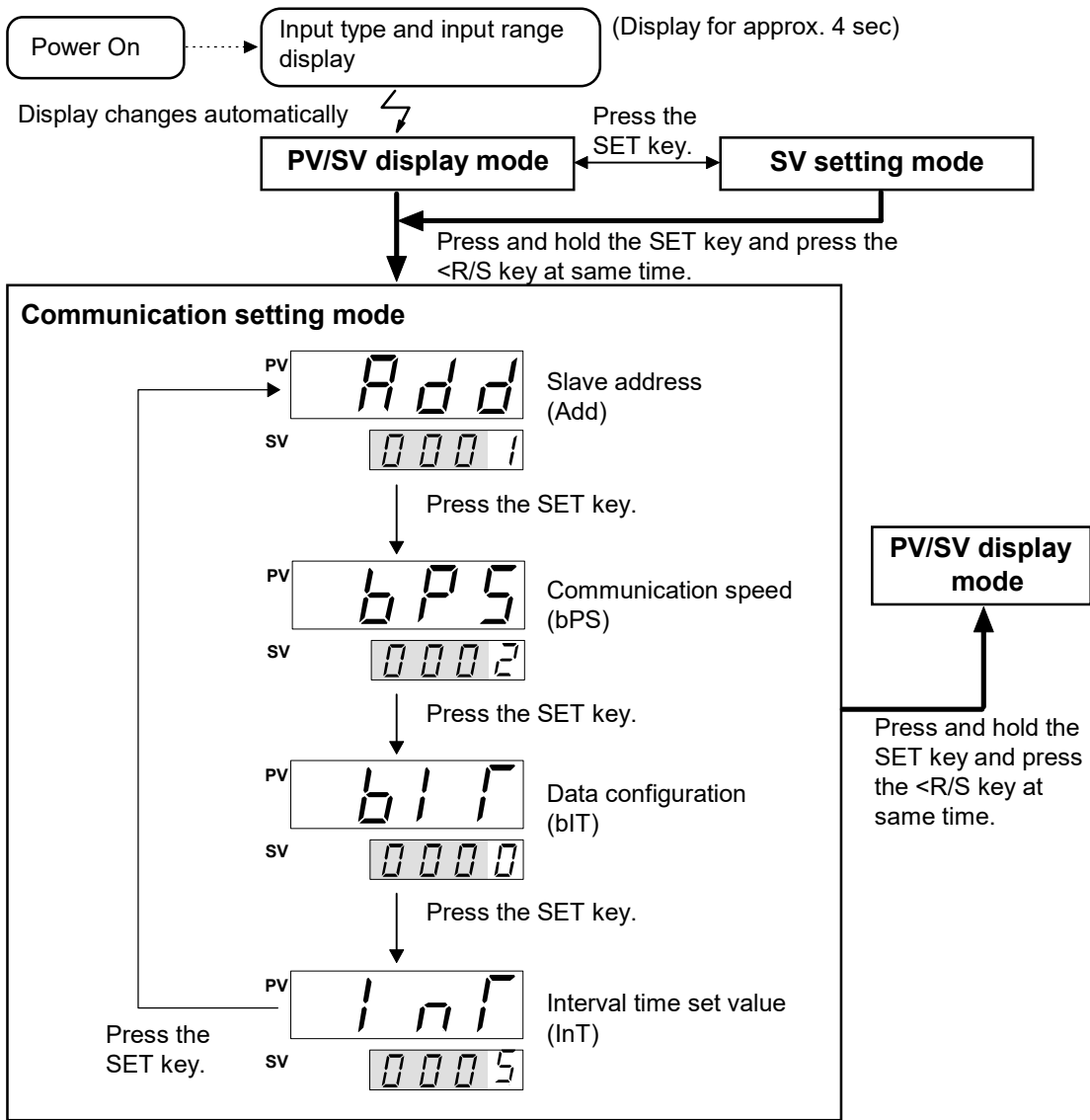



4.3 Slave Address Setting

The slave address must be set before Modbus communication can begin. The slave address number is set with numbers from 1 to 99. The factory set value is 0 and two-way communication is not possible when the address is 0.

Symbol	Name	Setting range	Description	Factory set value
<i>Add</i>	Slave address	1 to 99*	Set the controller slave address.	0
Add				

* Two-way communication is not possible when the address is 0.

 When the communication parameter is changed, turn the power on and off again to refresh and make the new value effective.

 All slave address settings must be stored by pressing the SET key. If changes are made and the SET key is not pressed within one minute, the display will automatically return to the PV/SV display mode and the slave address will return to the value prior to set change.

■ Setting procedure

Example: Setting the slave address to 15

1. Go to the communication setting mode so that slave address, *Add*, is displayed.

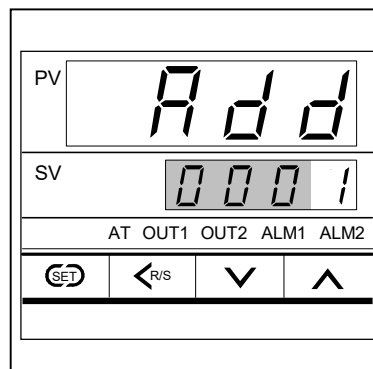

Slave address

2. Press the UP key to enter 5 at the first digit from the right.

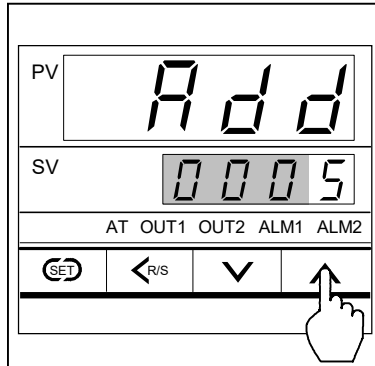

3. Press the <R/S key to high-light the second digit from the right.

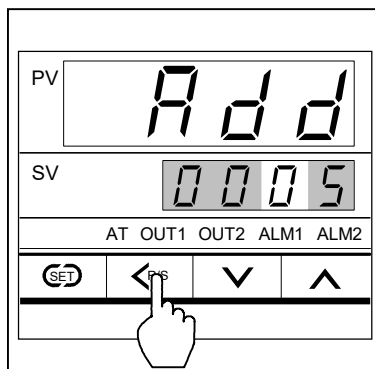

4. Press the UP key to enter 1 at the second digit from the right.

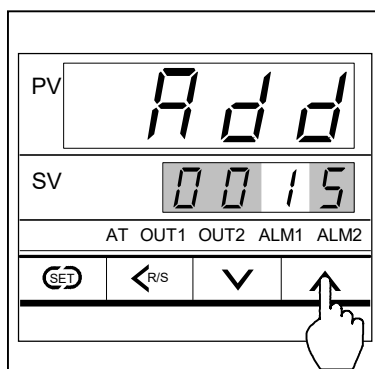



5. Press the SET key to store the new slave address. The display automatically goes to the next communication parameter, *bPS*.

4.4 Communication Speed Setting

The communication speed of 2400bps, 4800bps, 9600bps or 19200bps is set with numbers from 0 to 3. To change the number of the digit, press the UP or DOWN key.

Symbol	Name	Setting range	Description	Factory set value
bPS	Communication speed	0 : 2400 bps	Select the communication speed	2
bPS		1 : 4800 bps 2 : 9600 bps 3 : 19200 bps		

-  Set the same communication speed for both the slave and the master.
-  When the communication parameter is changed, turn the power on and off again to refresh and make the new value effective.
-  All communication speed settings must be stored by pressing the SET key. If changes are made and the SET key is not pressed within one minute, the display will automatically return to the PV/SV display mode and the communication speed will return to the value prior to set change.

■ Setting procedure

Example: Setting the communication speed to 1: 4800 bps

1. Go to the communication setting mode so that slave address, *Add*, is displayed. Then, press the SET key once, so the communication speed symbol, *bPS*, appears.

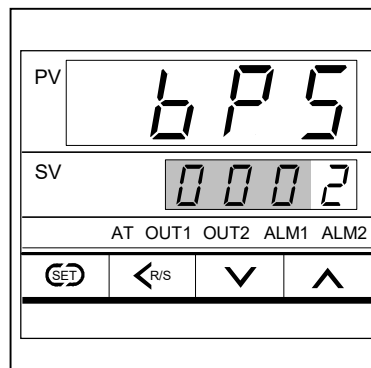

Communication speed

2. Press the DOWN key to enter 1 (4800 bps) at the first digit from the right.

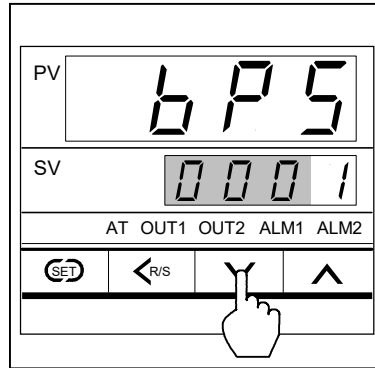

3. Press the SET key to store the new communication speed. The display automatically goes to the next communication parameter, *BIT*.



4.5 Data Configuration Setting

The data configuration shown below is set with numbers from 1 to 3. To change the number of the digit, press the UP or DOWN key.

Symbol	Name	Setting range	Description	Factory set value
<i>bit</i>	Data configuration	0, 6 or 7	Select data configuration during communication	0
bit		See Data Configuration Table		

Data configuration table

Setting	Data bit	Parity bit	Stop bit
0	8	None	1
1 to 5	Do not set 1 to 5. Malfunction may result.		
6	8	Even	1
7	8	Odd	1

-  Set the same data configuration for both the slave and the master.
-  When the communication parameter is changed, turn the power on and off again to refresh and make the new value effective.
-  All data configuration settings must be stored by pressing the SET key. If changes are made and the SET key is not pressed within one minute, the display will automatically return to the PV/SV display mode and the data configuration will return to the value prior to set change.

■ Setting procedure

Example: Setting the data configuration to 6: 8 data bits, even parity and 1 stop bit.

1. Go to the communication setting mode so that slave address, *Add*, is displayed. Press the SET key until the data configuration symbol, *bIT*, appears.

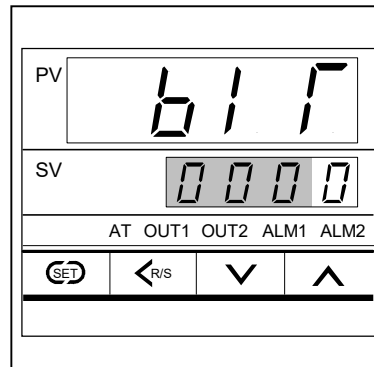

Data configuration

2. Press the UP key to enter 6 at the first digit from the right.

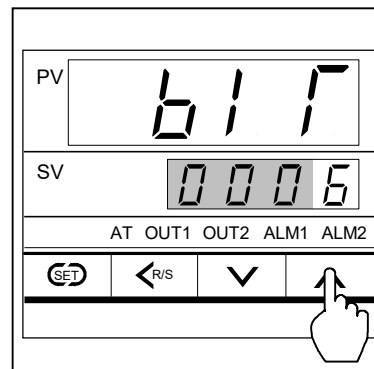

3. Press the SET key to store the new data configuration. The display automatically goes to the next communication parameter, *InT*.

4.6 Interval Time Setting

The interval time from 0 to 250 ms is set with numbers from 0 to 150. To shift the digit, press the <R/S key. To change the number of the digit, press the UP or DOWN key.

Symbol	Name	Setting range	Description	Factory set value
<i>InT</i>	Interval time set value	0 to 150*	Set the value to set the interval time	5
InT				

* 0 to 250 ms can be set by using 0 to 150.

Formula to calculate interval time and interval time set value

$$\text{Interval time} = \text{Interval time set value} \times 1.666 \text{ ms}$$

$$\text{Interval time set value} = \text{Interval time} \div 1.666 \text{ ms}$$

 When the communication parameter is changed, turn the power on and off again to refresh and make the new value effective.

 All interval times must be stored by pressing the SET key. If changes are made and the SET key is not pressed within one minute, the display will automatically return to the PV/SV display mode and the interval time will return to the value prior to set change.

■ Setting procedure

Example: Setting the interval time to 250 ms.

1. Go to the communication setting mode so that slave address, *Add*, is displayed. Press the SET key until the communication speed, *InT*, appears.

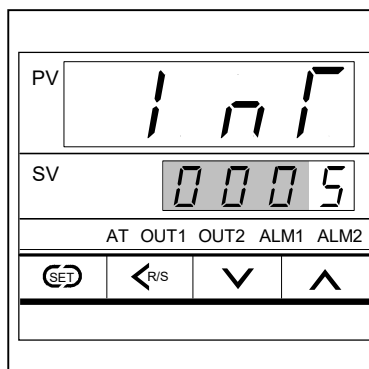

Interval time set value

2. Calculate the interval time set value by using the formula on the previous page. The interval time set value must be a whole number. If you get a number with a decimal fraction, round to the nearest whole number.

Interval time set value:

$$250 \text{ ms} \div 1.666 \text{ ms} \approx 150 \text{ (Round to the nearest whole number)}$$

The actual interval time re-calculated by using the interval time set value, 150:

$$150 \times 1.666 \text{ ms} \approx 249.9 \text{ (Approx. 250 ms)}$$

Enter an interval time set value of 150, calculated as show above, on the controller.

3. Press the DOWN key to enter 0 at the first digit from the right.

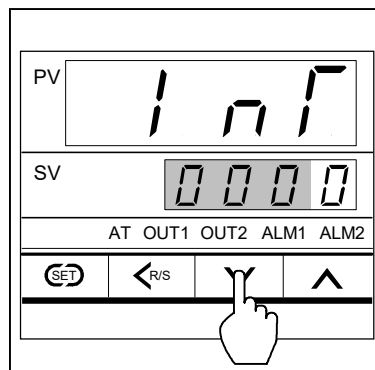

4. Press the <R/S key to high-light the second digit from the right.

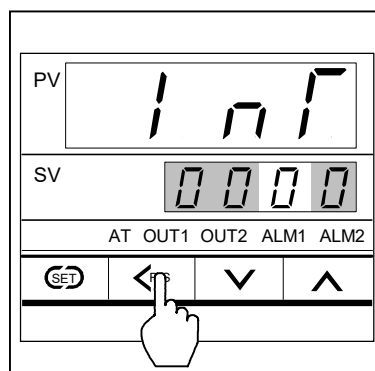

4. SETTING FOR COMMUNICATION

5. Press the UP key to enter 5 at the second digit from the right.

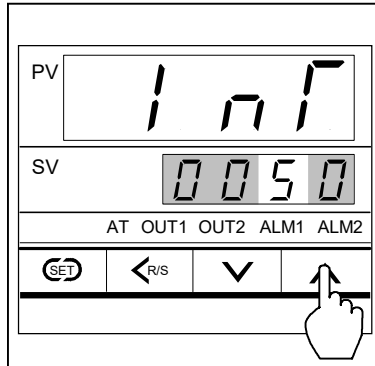

6. Press the <R/S key to high-light the third digit from the right.

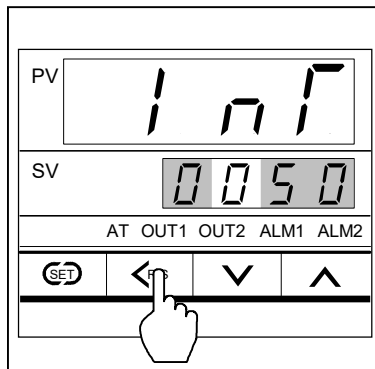

7. Press the UP key to enter 1 at the third digit from the right.

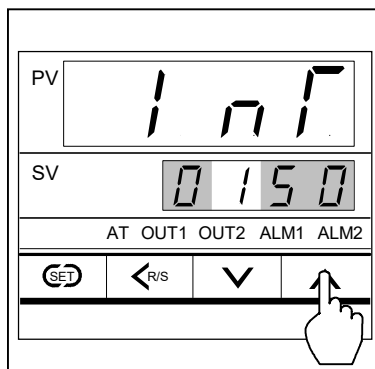

8. Press the SET key to store the new interval time. The display automatically goes back to the communication parameter, *Add*.

4.7 RS-485 Send/Receive Process Timing

The sending and receiving of RS-485 communication is conducted through two wires; consequently, the transmission and reception of data requires precise timing. The following processing times are required during data send/receive.

Slave process timing

Procedure details	Time (ms)
Read holding registers [03H] Response transmission time after the slave receives the query message	13 ms max.
Preset single register [06H] Response transmission time after the slave receives the query message	6 ms max.
Diagnostics (loopback test) [08H] Response transmission time after the slave receives the query message	6 ms max.

5. MODBUS PROTOCOL

The master controls communication between master and slave. A typical message consists of a request (query message) sent from the master followed by an answer (response message) from the slave. When master begins data transmission, a set of data is sent to the slave in a fixed sequence. When it is received, the slave decodes it, takes the necessary action, and returns data to the master.

5.1 Message Format

The message consists of four parts: slave address, function code, data, and error check code which are always transmitted in the same sequence.

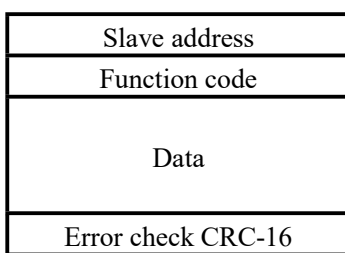

Message format

■ Slave address

The slave address is a number from 1 to 99 manually set at the front key panel of the controller. Although all connected slaves receive the query message sent from the master, only the slave with the slave address coinciding with the query message will accept the message.

■ Function code

The function codes are the instructions set at the master and sent to the slave describing the action to be executed. The function codes are included when the slave responds to the master.

For details, see **5.2 Function Code**.

■ Data

The data to execute the function specified by the function code is sent to the slave and corresponding data returned to the master from the slave.

For details, see **6. MESSAGE FORMAT**, **7. DATA CONFIGURATION** and **7.3 Communication Data List**.

■ Error check

An error checking code (CRC-16: Cyclic Redundancy Check) is used to detect an error in the signal transmission. For the calculation method of CRC-16, see **5.5 Calculating CRC-16**.

5.2 Function Code

● Function code contents

Function code (Hexadecimal)	Function	Contents
03H	Read holding registers	Measured value (PV), alarm status, current transformer input, etc.
06H	Preset single register	Set value (SV), alarm set value, PID constants, PV bias, etc. (For each word)
08H	Diagnostics (loopback test)	Diagnostics (loopback test)

● Message length of each function (Unit: byte)

Function code (Hexadecimal)	Function	Query message		Response message	
		Min	Max	Min	Max
03H	Read holding registers	8	8	7	255
06H	Preset single register	8	8	8	8
08H	Diagnostics (loopback test)	8	8	8	8

5.3 Communication Mode

Signal transmission between the master and slaves is conducted in Remote Terminal Unit (RTU) mode.

RTU mode

Items	Contents
Data bit length	8 bit (Binary)
Start mark of message	Unused
End mark of message	Unused
Message length	See 5.2 Function Code
Data time interval	24 bit's time or less*
Error check	CRC-16

* The data time intervals in one query message from the master must be 24 bit's time or less. If the data time interval exceeds 24 bit's time, the slave regards the transmission as ended and because the message format is incomplete, the slave does not respond.

5.4 Slave Responses

(1) Normal response

- In the response message of the Read Holding Registers, the slave returns the read out data and the number of data items with the same slave address and function code as the query message.
- In the response message of the Preset Single Register, the slave returns the same message as the query message.
- In the response message of the Diagnostics (loopback test), the slave returns the same message as the query message.

(2) Defective message response

- If the query message from the master is defective, except for transmission error, the slave returns the error response message without any action.

Slave address
Function code
Error code
Error check CRC-16

Error response message

- If the self-diagnostic function of the slave detects an error, the slave will return an error response message to all query messages.
- The function code of each error response message is obtained by adding 80H to the function code of the query message.

Error code	Contents
1	Function code error (Designation of an unsupported function code)
2	When written to <i>read only</i> data When any address other than 0000H to 0019H is specified When PID constants or anti-reset windup (ARW) data are set to 0 and 1 is entered at self-tuning (ST) function When either one of PID constants and anti-reset windup (ARW) data are written during execution of the self-tuning (ST) function
3	When the data written exceeds the setting range When the specified number of data items in the query message exceeds the maximum number of data items available
4	Self-diagnostic error response

(3) No response

The slave ignores the query message and does not respond when:

- The slave address in the query message does not coincide with any slave address settings.
- The transmission parameter of the master does not coincide with that of the slave.
- Transmission error such as overrun, framing, parity and etc., is found in the query message.
- Data time interval in the query message from the master exceeds 24 bit's time.

5.5 Calculating CRC-16

The Cyclic Redundancy Check (CRC) is a 2 byte (16-bit) error check code. After constructing the data message, not including start, stop, or parity bit, the master calculates a CRC code and appends this to the end of the message. The slave will calculate a CRC code from the received message, and compare it with the CRC code from the master. If they do not coincide, a communication error has occurred and the slave does not respond.

The CRC code is formed in the following sequence:

1. Load a 16-bit CRC register with FFFFH.
2. *Exclusive OR* (\oplus) the first byte (8 bits) of the message with the CRC register. Return the result to the CRC register
3. Shift the CRC register 1 bit to the right.
4. If the carry flag is 1, exclusive OR the CRC register with A001 hex and return the result to the CRC register. If the carry flag is 0, repeat step 3.
5. Repeat step 3 and 4 until there have been 8 shifts.
6. *Exclusive OR* the next byte (8 bits) of the message with the CRC register..
7. Repeat step 3 through 6 for all bytes of the message (except the CRC).
8. The CRC register contains the 2 byte CRC error code. When they are appended to the message, the low-order byte is appended first, followed by the high-order byte.

■ The flow chart of CRC-16

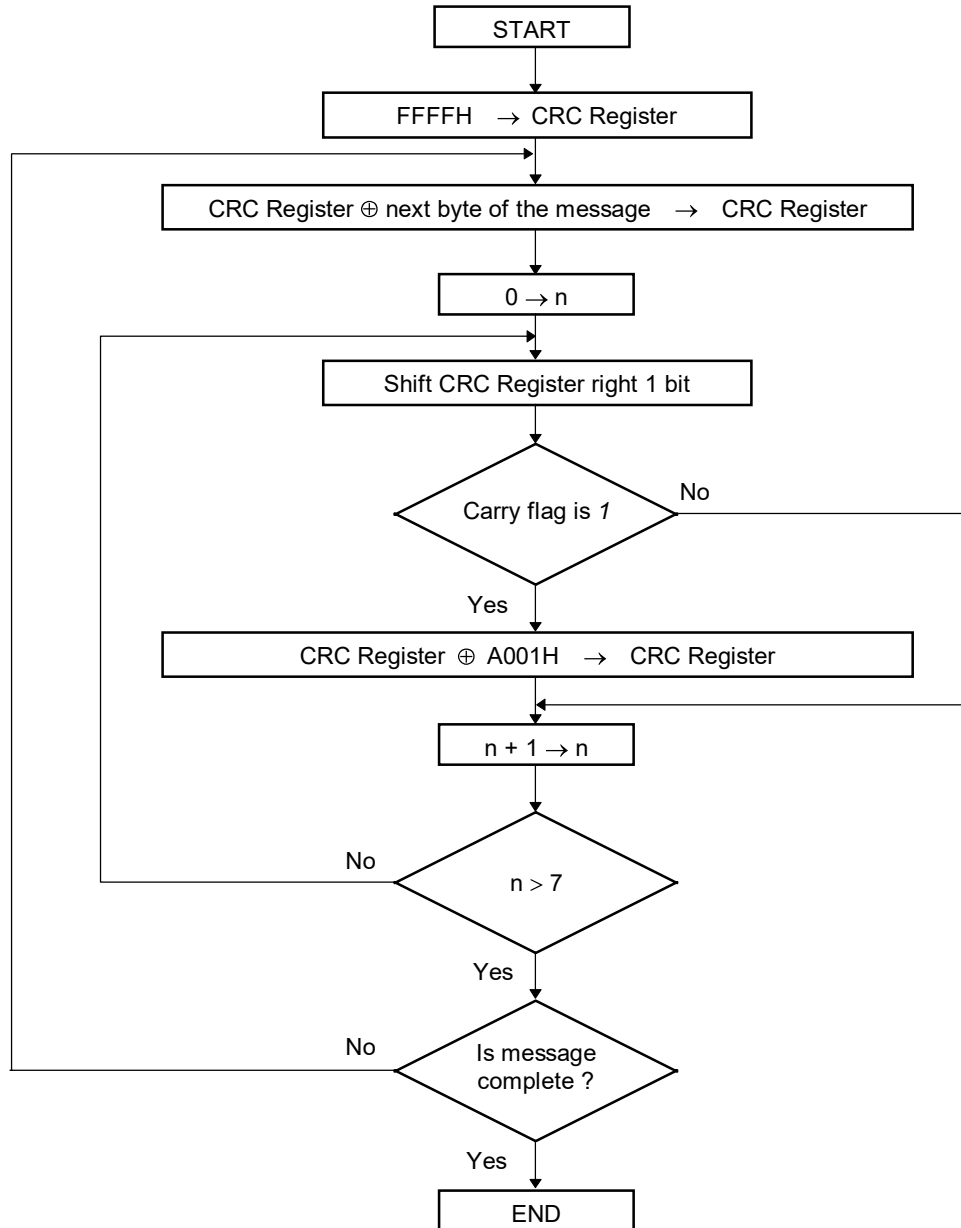

The \oplus symbol indicates an *exclusive OR* operation.

The symbol for the number of data bits is n .

6. MESSAGE FORMAT

6.1 Read Holding Registers [03H]

The query message specifies the starting register address and quantity of registers to be read. The contents of the holding registers are entered in the response message as data, divided into two parts: the high-order 8 bits and the low-order 8 bits, arranged in the order of the register numbers.

Example: The contents of the three holding registers from 0000H to 0002H are the read out from slave address 2.

Query message

Slave address		02H	
Function code		03H	
Starting number	High	00H	} First holding register address
	Low	00H	
Quantity	High	00H	} The setting must be between 1 and 125 (0001H and 007DH)
	Low	03H	
CRC-16	High	05H	
	Low	F8H	

Normal response message

Slave address		02H	
Function code		03H	
Number of data		06H	→ Number of holding registers × 2
First holding register contents	High	00H	
	Low	64H	
Next holding register contents	High	00H	
	Low	00H	
Next holding register contents	High	00H	
	Low	00H	
CRC-16	High	44H	
	Low	4DH	

Error response message

Slave address		02H
80H + Function code		83H
Error code		03H
CRC-16	High	F1H
	Low	31H

6.2 Preset Single Register [06H]

The query message specifies data to be written into the designated holding register. The write data is arranged in the query message with high-order 8 bits first and low-order 8 bits next. Only R/W holding registers can be specified.

Example: Data is written into the holding register 0006H of slave address 1.

Query message

Slave address		01H	} Any data within the range
Function code		06H	
Holding register number	High	00H	
	Low	06H	
Write data	High	00H	
	Low	C8H	
CRC-16	High	68H	
	Low	5DH	

Normal response message

Slave address		01H	} Contents will be the same as query message data.
Function code		06H	
Holding register number	High	00H	
	Low	C6H	
Write data	High	00H	
	Low	08H	
CRC-16	High	68H	
	Low	5DH	

Error response message

Slave address		01H
80H + Function code		86H
Error code		02H
CRC-16	High	C3H
	Low	A1H

6.3 Diagnostics (Loopback Test) [08H]

The master's query message will be returned as the response message from the slave. This function checks the communication system between the master and slave.

Example: Loopback test for slave address 1

Query message

Slave address		01H	
Function code		08H	
Test code	High	00H	} Test code must be set to 00
	Low	00H	
Data	High	1FH	} Any pertinent data
	Low	34H	
CRC-16	High	E9H	
	Low	ECH	

Normal response message

Slave address		01H	
Function code		08H	
Test code	High	00H	} Contents will be the same as query message data.
	Low	00H	
Data	High	1FH	
	Low	34H	
CRC-16	High	E9H	
	Low	ECH	

Error response message

Slave address		01H
80H + Function code		88H
Error code		03H
CRC-16	High	06H
	Low	01H

7. DATA CONFIGURATION

7.1 Data Configuration

The numeric range of data used in Modbus protocol is 0000H to FFFFH. Only the set value within the setting range is effective.

 FFFFH represents -1.

Data processing with decimal points

■ Data with decimal points

The Modbus protocol does not recognize data with decimal points during communication.

● Data with one decimal place

Current transformer input 1	Heater break alarm 1
Current transformer input 2 (Z-168 specification)	Heater break alarm 2 (Z-168 specification)
Control loop break alarm	

Example: When heater break alarm (HBA) 1 set value is 20.0 A; 20.0 is processed as 200, 200 = 00C8H

Heater break alarm 1	High	00H
	Low	C8H

■ Data without decimal points

Alarm 1 status	Derivative time
Alarm 2 status	Anti-reset windup
Burnout	Heat-side proportioning cycle time
LBA deadband	Cool-side proportional band
Autotuning (AT)	Cool-side proportioning cycle time
Self-tuning (ST)	Set data lock function
Integral time	RUN/STOP function

Example: When integral time is 50 seconds, 50 is processed as 50, 50 = 0032H

Integral time	High	00H
	Low	32H

■ Data whose decimal point's presence and/or position depends on input range

The position of the decimal point changes depending on the input range type because the Modbus protocol does not recognize data with decimal points during communication.

The following data can have one of three decimal point positions:

- No decimal point
- One decimal place
- Two decimal places

The input range for voltage/current input is fixed at 0.0 to 100.0%. For details, see Input Range Table 2 on P.34.

Measured value (PV)	Heat-side proportional band
Set value (SV)	Deadband
Alarm 1 set value	PV bias
Alarm 2 set value	

Example: When the temperature set value is -20.0 °C; -20.0 is processed as -200,
 -200 = 0000H - 00C8H = FF38H

Set value (SV)	High	FFH
	Low	38H

7.2 Data Processing Precautions

- For 03H (data read from the holding register), an error response message is returned when any address other than 0000H to 0019H is specified as the starting number.
- For 06H (data write to the single holding register), an error response message is returned when data is written to any address other than 0000H to 0019H.
- Read data of unused channel and undefined address is 0.
- Any attempt to write to an unused channel is not processed as an error. Data can not be written into an unused channel.
- If data range or address error occurs during data writing, the data written before error is in effect.

7.3 Communication Data List

The communication data list summarizes data addresses (holding register numbers), names, attributes, setting ranges and factory set values.

(Attribute RO: Read only R/W: Read and Write)

Address	Name	Attribute	Data range or item description	Factory set value
00H	Measured value (PV)	RO	Within input range	-
01H	Current transformer input 1	RO	0.0 to 100.0 A	-
02H	Current transformer input 2 *1	RO	0.0 to 100.0 A	-
03H	Alarm 1 status	RO	0: OFF 1: ON	-
04H	Alarm 2 status	RO	0: OFF 1: ON	-
05H	Burnout	RO	0: OFF 1: ON	-
06H	Set value (SV)	R/W	Within input range	0
07H	Alarm 1 set value	R/W	Temperature input: Process alarm, deviation alarm, SV alarm: -1999 to +9999 °C [°F] or -199.9 to +999.9 °C [°F]	Temperature input: 50 or 50.0
08H	Alarm 2 set value		Voltage/current inputs: Deviation alarm: -span to +span (Within 9999) Process alarm, SV alarm: Within input range	Voltage/ current inputs: 5.0
09H	Heater break alarm 1	R/W	0.0 to 100.0 A	0.0
0AH	Heater break alarm 2 *2	R/W	0.0 to 100.0 A	0.0
0BH	Control loop break alarm	R/W	0.1 to 200.0 min. (0.0 can not be set.)	8.0
0CH	LBA deadband	R/W	Temperature input: 0 to 9999 °C [°F] Voltage/current inputs: 0 to 100 % of span	0
0DH	Autotuning (AT)	R/W	0: Autotuning (AT) end or suspension 1: Autotuning (AT) start* *After AT is completed, setting will automatically change to 0	0
0EH	Self-tuning (ST) *3	R/W	0: Self-tuning (ST) suspension 1: Self-tuning (ST) start	0

Continued on the next page.

Continued from the previous page.

(Attribute RO: Read only R/W: Read and Write)

Address	Name	Attribute	Data range or item description	Factory set value
0FH	Heat-side proportional band (P) *4	R/W	Temperature input: 1 (0.1) to span or 9999 (999.9) °C [°F] Voltage/current inputs: 0.1 to 100.0 % of span (ON/OFF action control when set to 0 or 0.0.) <i>Can not be set while the self-tuning (ST) function is On</i>	Temperature input: 30 (30.0) Voltage/current inputs: 3.0
10H	Integral time (I) *4	R/W	1 to 3600 sec (0: PD control) <i>Can not be set while the self-tuning (ST) function is On</i>	240
11H	Derivative time (D) *4	R/W	1 to 3600 sec (0: PI control) <i>Can not be set while the self-tuning (ST) function is On</i>	60
12H	Anti-reset windup (ARW) *4	R/W	1 to 100 % of heat-side proportional band (0: Integral action OFF) <i>Can not be set while the self-tuning (ST) function is On</i>	100
13H	Heat-side proportioning cycle time	R/W	1 to 100 sec (0 can not be set.) <i>Can not be set if the control output is current output.</i>	*5
14H	Cool-side proportional band	R/W	1 to 1000% of heat-side proportional band (0 can not be set.)	100
15H	Deadband	R/W	Temperature input: -10 to +10 °C [°F] or -10.0 to +10.0 °C [°F] Voltage/current inputs: -10.0 to +10.0 % of span	0 or 0.0
16H	Cool-side proportioning cycle time	R/W	1 to 100 sec (0 can not be set.) <i>Can not be set if the control output is current output.</i>	*6
17H	PV bias	R/W	-span to +span However, temperature inputs: -1999 to +1999 °C [°F] or -199.9 to 999.9 °C [°F]	0 or 0.0

Continued on the next page.

Continued from the previous page.

(Attribute RO: Read only R/W: Read and Write)

Address	Name	Attribute	Data range or item description	Factory set value
18H	Set data lock function	R/W	0 to 7 *7	0
19H	RUN/STOP function	R/W	0: RUN 1: STOP	0

*1 For the current transformer input 2 function, Z-168 specification is required.

*2 For a unit without Z-168 specification, the read data is 0.

*3 When heating proportional band (P), integral time (I), derivative time (D) or anti-reset windup (ARW) is set to 0, self-tuning (ST) cannot be set to 1, self-tuning start. Error code 2 is sent.

*4 The heat-side proportional band (P), integral time (I), derivative time (D) and anti-reset windup (ARW) cannot be set while the self-tuning (ST) function is being executed. Error code 2 is sent.

*5 Relay contact output: 20 sec

Voltage pulse output, trigger output for triac driving, triac output: 2 sec

*6 Relay contact output: 20 sec

Voltage pulse output, triac output: 2 sec

*7 Details of set data lock selection.

Set data	Set value (SV)	Alarm setting set value (Alarm 1, Alarm 2)	Other setting items
0	×	×	×
1	×	×	-
2	×	-	×
3	×	-	-
4	-	×	×
5	-	×	-
6	-	-	×
7	-	-	-

(-) Unsettable-Data locked (×) Settable-Data unlocked

The data lock function only prevents setting changes being made from the front keys. Setting changes can still be made through communication transmission.

 Reading RO (read only) and R/W (read/write) unused data are not processed as an error at read holding registers, but read data will be 0.

 Any attempt to write unused data is not processed as an error. Data can not be written into the slave.

■ Input Range Tables

Input Range Table 1

Input type		Input range	Code		
			Input	Range	
Thermocouple (TC)	K	0 to 200 °C	K	01	
		0 to 400 °C	K	02	
		0 to 600 °C	K	03	
		0 to 800 °C	K	04	
		0 to 1000 °C	K	05	
		0 to 1200 °C	K	06	
		0 to 1372 °C	K	07	
		0 to 100 °C	K	13	
		0 to 300 °C	K	14	
		0 to 450 °C	K	17	
		0 to 500 °C	K	20	
		0 to 800 °F	K	A1	
		0 to 1600 °F	K	A2	
		0 to 2502 °F	K	A3	
		20 to 70 °F	K	A9	
	J	0 to 200 °C	J	01	
		0 to 400 °C	J	02	
		0 to 600 °C	J	03	
		0 to 800 °C	J	04	
		0 to 1000 °C	J	05	
		0 to 1200 °C	J	06	
		0 to 450 °C	J	10	
		0 to 800 °F	J	A1	
		0 to 1600 °F	J	A2	
		0 to 2192 °F	J	A3	
		0 to 400 °F	J	A6	
		0 to 300 °F	J	A7	
	R	0 to 1600 °C	*1	R	01
		0 to 1769 °C	*1	R	02
		0 to 1350 °C	*1	R	04
		0 to 3200 °F	*1	R	A1
		0 to 3216 °F	*1	R	A2
	S	0 to 1600 °C	*1	S	01
		0 to 1769 °C	*1	S	02
		0 to 3200 °F	*1	S	A1
		0 to 3216 °F	*1	S	A2

Continued on the next page.

Continued from the previous page.

Input type		Input range		Code	
				Input	Range
Thermocouple (TC)	E	0 to 800 °C		E	01
		0 to 1000 °C		E	02
		0 to 1600 °F		E	A1
		0 to 1832 °F		E	A2
	N	0 to 1200 °C		N	01
		0 to 1300 °C		N	02
		0 to 2300 °F		N	A1
		0 to 2372 °F		N	A2
	T	-199.9 to +400.0 °C *2		T	01
		-199.9 to +100.0 °C *2		T	02
		-100.0 to +200.0 °C		T	03
		0.0 to 350.0 °C		T	04
		-199.9 to +752.0 °F *2		T	A1
		-100.0 to +200.0 °F *2		T	A2
		-100.0 to +400.0 °F *2		T	A3
		0.0 to 450.0 °F		T	A4
		0.0 to 752.0 °F		T	A5
	PL II	0 to 1300 °C		A	01
		0 to 1390 °C		A	02
		0 to 1200 °C		A	03
		0 to 2400 °F		A	A1
		0 to 2534 °F		A	A2
	U	-199.9 to +600.0 °C *2		U	01
		-199.9 to +100.0 °C *2		U	02
		0.0 to 400.0 °C		U	03
		-199.9 to +999.9 °F *2		U	A1
		-100.0 to +200.0 °F *2		U	A2
		0.0 to 999.9 °F		U	A3
	L	0 to 400 °C		L	01
		0 to 800 °C		L	02
		0 to 800 °F		L	A1
		0 to 1600 °F		L	A2

Continued on the next page.

Continued from the previous page.

Input type		Input range	Code	
			Input	Range
RTD	Pt100 Ω	-199.9 to +649.0 °C	D	01
		-199.9 to +200.0 °C	D	02
		-100.0 to +50.0 °C	D	03
		-100.0 to +100.0 °C	D	04
		-100.0 to +200.0 °C	D	05
		0.0 to 50.0 °C	D	06
		0.0 to 100.0 °C	D	07
		0.0 to 200.0 °C	D	08
		0.0 to 300.0 °C	D	09
		0.0 to 500.0 °C	D	10
		-199.9 to +999.9 °F	D	A1
		-199.9 to +400.0 °F	D	A2
		-199.9 to +200.0 °F	D	A3
		-100.0 to +100.0 °F	D	A4
		-100.0 to +300.0 °F	D	A5
		0.0 to 100.0 °F	D	A6
		0.0 to 200.0 °F	D	A7
		0.0 to 400.0 °F	D	A8
	0.0 to 500.0 °F	D	A9	
	JPt100 Ω	-199.9 to +649.0 °C	P	01
		-199.9 to +200.0 °C	P	02
		-100.0 to +50.0 °C	P	03
		-100.0 to +100.0 °C	P	04
		-100.0 to +200.0 °C	P	05
		0.0 to 50.0 °C	P	06
		0.0 to 100.0 °C	P	07
		0.0 to 200.0 °C	P	08
0.0 to 300.0 °C		P	09	
0.0 to 500.0 °C		P	10	

*1 Accuracy is not guaranteed between 0 to 399 °C (0 to 799 °F).

*2 Accuracy is not guaranteed between -199.9 to -100.0 °C (-199.9 to -158.0 °F).

Input Range Table 2

Input type	Input range		Code	
			Input	Range
Voltage input (V)	DC 0 to 5 V	0.0 to 100.0 %	4	01
	DC 0 to 10 V*		5	01
	DC 1 to 5 V		6	01
Current input (mA)	DC 0 to 20 mA		7	01
	DC 4 to 20 mA		8	01

* For this voltage range, Z-1010 specification is required.

8. TROUBLESHOOTING



WARNING

- To prevent electric shock or instrument failure, always turn off the system power before replacing the instrument.
- To prevent electric shock or instrument failure, always turn off the power before mounting or removing the instrument.
- To prevent electric shock or instrument failure, do not turn on the power until all the wiring is completed.
- To prevent electric shock or instrument failure, do not touch the inside of the instrument.
- All wiring must be performed by authorized personnel with electrical experience in this type of work.

This section lists some basic causes and solutions for Modbus communication problems. If you can not find a solution, contact your nearest RKC sales office or agent for additional information about replacement or repair.

Symptom	Probable cause	Solution
No response	The controller power is not turned on	Turn on the power
	There communication cable is improperly connected	Confirm the connection method
	Breakage in the communication cable	Replace the cable
	Detachment of the communication cable	Confirm the connection condition
	Problems with the connectors or contacts	Check and replace the wiring in the connector
	The communication speed or bit structure settings are different	Confirm each setting
	The address specification is different	Confirm the address numbers
	A transmission error (overrun error, framing error, parity error or CRC-16 error) is found in the query message	Re-transmit after time-out occurs or verify communication program
	The time interval between adjacent data in the query message is too long, exceeding 24 bit's time	
	Instrument failure	Replace instrument or return for repair

Continued on the next page.

Continued from the previous page.

Symptom	Probable cause	Solution
Error code 1	Function code error (An unsupported function code was specified)	Confirm the function code
Error code 2	Written to <i>read only</i> data.	Confirm the address of holding register
	Any address other than 0000H to 0019H is specified.	
	PID constants or anti-reset windup (ARW) data are set to 0 and 1 is entered at self-tuning (ST) function	Set the PID constants and anti-reset windup (ARW) data to any number other than 0.
	Either one of PID constants and anti-reset windup (ARW) data are written during execution of the self-tuning (ST) function.	Set the self-tuning (ST) function to 0.
Error code 3	The data written exceeds the setting range.	Confirm the setting data
	When the specified number of data items in the query message exceeds the maximum number of data items available.	Re-set the data within the range of 1 to 125 (0000H to 007DH).
Error code 4	Self-diagnostic error	Turn off the power to the instrument. If the same error occurs when the power is turned back on, contact your nearest RKC sales office or agent.



Error codes 1 to 4 indicate that an error response message has been transmitted.