

# SELECTOR SWITCHES

## VOLTAGE AND CURRENT SELECTOR SWITCHES MODEL 9524xx

### FEATURES

- Heavy duty switchgear style design.
- Terminals easily accessible for wiring.
- Large screws and saddle wiring clamps.
- Custom configurations available.

All models on this page  
UL Recognized



### APPLICATIONS

- For AMMETERS and VOLTMETERS

### RATING

- Open continuous rating: 30A, 600V

**INTERRUPTING RATINGS:**  
UL and CUL General Purpose

- 20A-120Vac
- 15A-240Vac
- 6A-600Vac
- 3A-125Vdc
- 1A-250Vdc



### OPERATOR

It is suitable for steel panel, insulated panel, or centralized motor control clusters. A nameplate is included.

## SWITCH DIMENSIONS

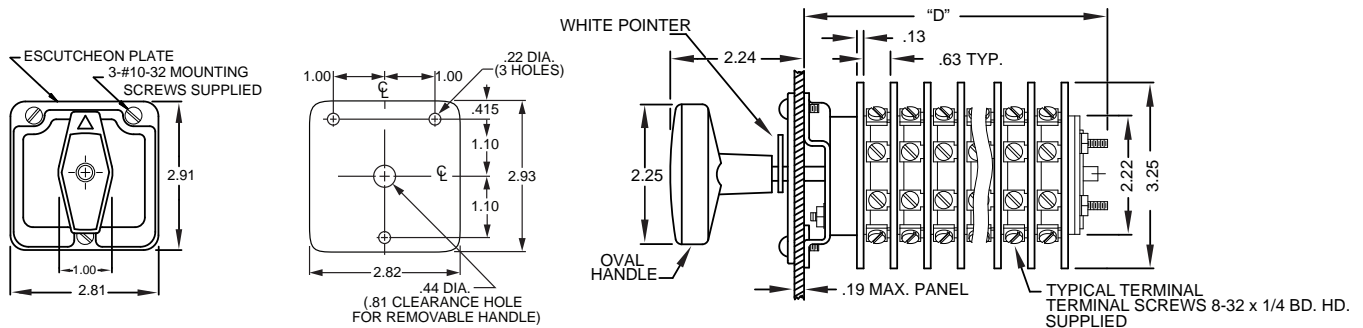

All Dimensions In Inches

MODELS AVAILABLE			
CATALOG NUMBER	FUNCTION	DECKS	DIM "D"
952403C	VOLTMETER, 3 Phase, Phase to Neutral	2	2.9
952404C	VOLTMETER, 3 Phase, Phase to Phase	2	2.9
952405C	VOLTMETER, 3 Phase, Phase to Phase and Phase to Neutral	2	2.9
952408C	AMMETER, 3 Phase, 2 Current Transformers	2	2.9
952410C	AMMETER, 3 Phase, 3 Current Transformers	2	2.9
952411C	AMMETER, 3 Current Transformers, Independent Circuits	6	5.4
952415C	AMMETER-VOLTMETER, 3 Phase, Phase to Phase, 3 Current Transformers	4	4.3

See the following pages for Schematics, Wiring Diagrams, and Contact Arrangement details.

**FLEX-CORE®**

# SELECTOR SWITCHES

## VOLTAGE AND CURRENT SELECTOR SWITCHES

MODEL 9524xx

VOLTMETER  
Transfer Switch  
3 Phase,  
Phase to Neutral

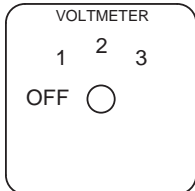

952403C

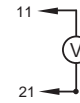
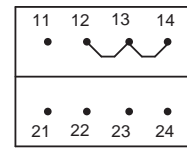
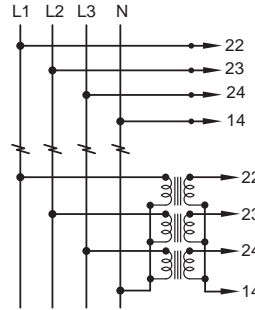
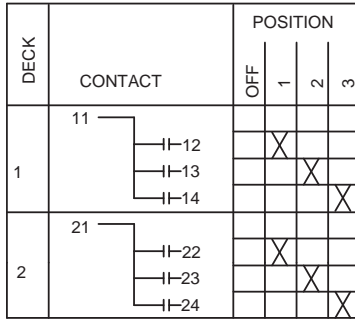

VOLTMETER  
Transfer Switch  
3 Phase,  
Phase to Phase

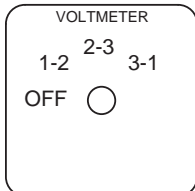

952404C

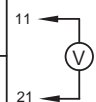
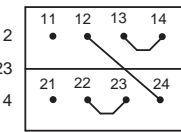
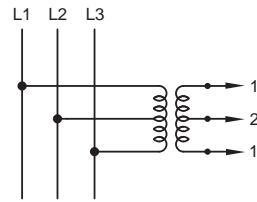
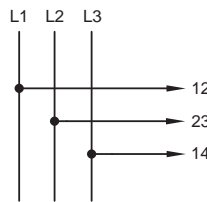
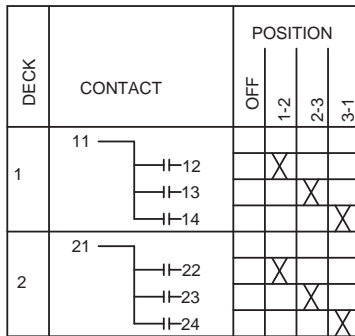

VOLTMETER  
Transfer Switch  
3 Phase,  
Phase to Phase  
and Phase to Neutral

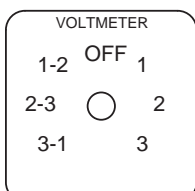

952405C

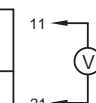
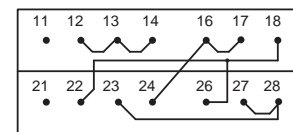
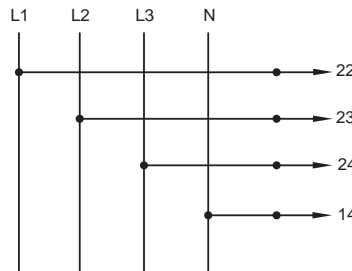
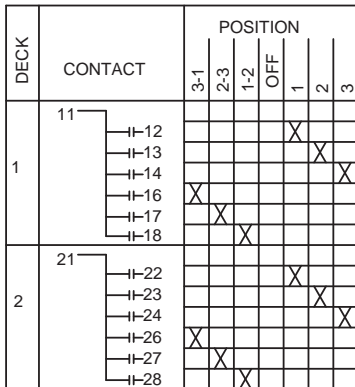

AMMETER  
Transfer Switch  
3 Phase,  
2 Current Transformers

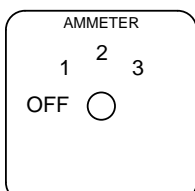

952408C

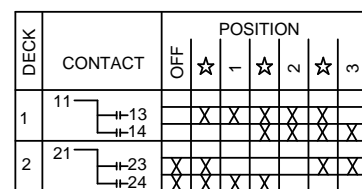

☆ DENOTES MAKE BEFORE BREAK

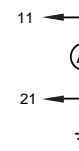
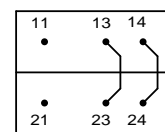
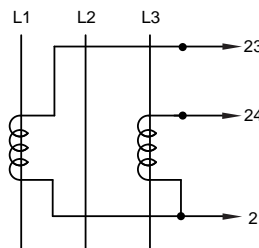

**FLEX-CORE®**

# SELECTOR SWITCHES

## VOLTAGE AND CURRENT SELECTOR SWITCHES MODEL 9524xx

**AMMETER**  
Transfer Switch  
3 Phase,  
3 Current Transformers

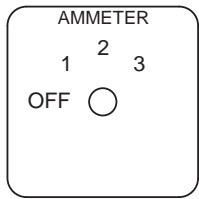

952410C

DECK	CONTACT	POSITION			
		OFF	1	2	3
1	11		☆		
	12	X			
	13	X			
	14	X			
2	21				
	22	X	X	X	X
	23	X	X	X	X
	24	X	X	X	X

☆ DENOTES MAKE BEFORE BREAK

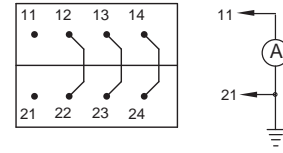
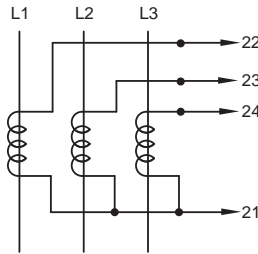

**AMMETER**  
Transfer Switch  
3 Current Transformers,  
Independent Circuits

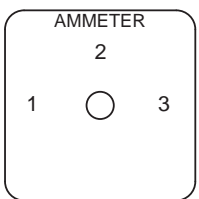

952411C

DECK	CONTACT	POSITION		
		1	2	3
1	11		☆	
	13	X		
	14	X		
	15	X		
	16	X		
2	21			
	23	X		
	24	X		
	25	X		
	26	X		
3	31			
	33	X		
	34	X		
	35	X		
	36	X		
4	41			
	43	X		
	44	X		
	45	X		
	46	X		
5	51			
	53	X		
	54	X		
	55	X		
	56	X		
6	61			
	63	X		
	64	X		
	65	X		
	66	X		

☆ DENOTES MAKE BEFORE BREAK

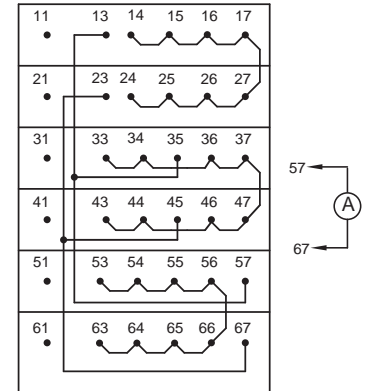
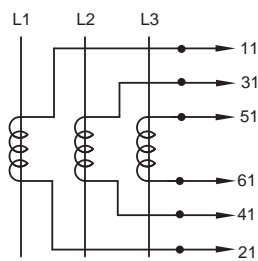

**AMMETER-VOLTMETER**  
Transfer Switch  
3 Phase,  
Phase to Phase,  
3 Current Transformers

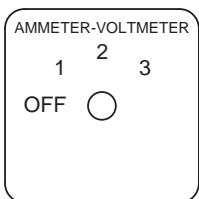

952415C

DECK	CONTACT	POSITION			
		OFF	1	2	3
1	11		☆		
	12				
	13				
	14				
2	21				
	22				
	23				
	24				
3	31				
	32	X	X	X	X
	33	X	X	X	X
	34	X	X	X	X
4	41				
	42	X	X	X	X
	43	X	X	X	X
	44	X	X	X	X

☆ DENOTES MAKE BEFORE BREAK

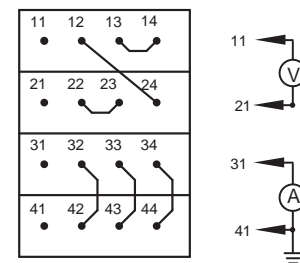
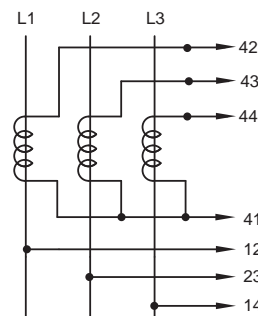

**FLEX-CORE®**