

BATTERY HiTESTER BT3563/BT3562/3561

Component measuring instruments



Simultaneous high-speed measurement of internal resistance and battery voltage

From large-cell to high-voltage battery testing - HIOKI is The Choice

The BT3563, BT3562, and 3561 BATTERY HiTESTERs support simultaneous high-speed measurement of internal resistance (IR) and battery voltage (OCV) for the ever-expanding production lines of increasingly larger lithium-ion low resistance batteries, and other battery packs for high voltage applications.

- Measure high-voltage battery packs up to 300V (with the BT3563)
- Ideal for high-precision cell voltage measurements (accurate to 0.01% of reading)
- Measurement circuitry employs enhanced current regulation
- Fast 10 ms response and 8 ms sampling time for high-speed measurements (with the BT3563 and BT3562)
- Ranges from 3 mΩ to 3000 Ω (with the BT3563 and BT3562) support coin-size to large-cell batteries



www.hioki.com

Find Quality Products Online at:

www.GlobalTestSupply.com

sales@GlobalTestSupply.com

Resistance and voltage measurements

BATTERY HiTESTER BT3563 BT3562 3561



■ Measurement Parameters and Applications

- High-voltage battery pack testing
- Battery module testing
- Large (low-resistance) cell testing
- High-speed mass production testing of coin batteries
- Fuel cell stack measurements
- Battery research and development measurement applications

BT3563
Up to
300V

BT3562
Up to
60V



Voltage measurement ranges: 6V/60V/300V (BT3563)
6V/60V (BT3562)

Resistance measurement ranges: 3mΩ/30mΩ/300mΩ/
3Ω/30Ω/300Ω/3000Ω

Lithium-Ion and Secondary Batteries



Cell phones



E-books



Electric bicycles



Electric scooters



EV/HEV

Battery-Powered Devices

■ Advanced Functions

● Four-Terminal AC Method

The four-terminal, 1-kHz AC method uses four contact probes to measure resistance independently of that of the measurement leads.

● Measurement Error Detection

Detects test probe contact failure and broken leads for 100%

● Self-Calibrating

Minor drift and gain fluctuations within the internal measurement circuitry are automatically corrected to maintain high accuracy.

● Averaging Function

Stable readings can be consistently obtained by averaging two to

to confirm finished quality

■ Features of Battery HiTester Series

High Precision

Resistance
 $\pm 0.5\%$ rdg. ± 5 dgt.
Voltage
 $\pm 0.01\%$ rdg. ± 3 dgt.

Common to the BT3563, BT3562 and 3561

High Resolution

Resistance: $0.1 \mu\Omega$ ^{*1}
(3 m Ω range)
Voltage: $10 \mu V$ ^{*1}
(6 V range)

^{*1} BT3563 and BT3562

Quick Response

Resistance & Voltage
Simultaneous measurements
within 18 ms^{*2}

^{*2} Sampling time + response time:
 with EX.FAST sampling
 BT3563 and BT3562

- The 3 m Ω range (with $0.1 \mu\Omega$ resolution) is ideal for testing ever lower-resistance large cells (BT3563 and BT3562).
- The 6 V range (with $10 \mu V$ resolution and 0.01% accuracy) is ideal for the high-precision voltage measurements required for cell testing (BT3563 and BT3562).

- Provides high-speed measurement of high-voltage^{*3} battery packs, for improving productivity (BT3563).

^{*3} BT3563: up to 300V
 BT3562: up to 60V

■ Measurement Parameters and Applications

BATTERY HiTESTER 3561

- For high-speed production line testing of small battery packs for mobile and portable communications devices
- For high-speed production line testing of small cells
- *High-speed 10ms inspection in the 300m Ω and 3 Ω ranges*
- *Improve inspection efficiency during mass production of compact cells*

3561
 Up to
20V



Voltage measurement ranges: 20V

Resistance measurement ranges: 300m Ω /3 Ω

Lithium-Ion and Secondary Batteries

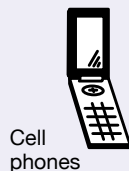

Battery-Powered Devices

Quick Response
 with small cell measurement

Resistance & Voltage
Simultaneous measurements
within 10 ms^{*4}

^{*4} Sampling time + response time:
 with EX.FAST sampling
 3561

Battery HiTester Series

- **Measurement Value Storage**
 Store up to 400 measurement values by external trigger input, for bulk transfer to a computer.
- **Statistical Calculations**
 Apply statistical calculations to up to 30,000 data points to facilitate process and quality control.

- **Save Measurement Setting Configurations**
 Up to 126 measurement configurations such as comparator setting criteria can be saved and reloaded. Saved configurations can be selected by external control.

Automatic Testing Lines

High Speed Interfaces

The fastest 10 ms measurement data can be transferred via the standard RS-232C interface at up to 38,400 bps. Models with the -01 suffix include a GP-IB interface.

Handler Interface

Triggering, measurement configuration loading, and zero adjustment can be externally controlled. Output signals provide comparator results, end-of-measurement events, and measurement errors. (Because the BT3563/BT3562 are different from the 3561, consult each model's Instruction Manual for specific details or designs.)

BT3563, BT3562 and 3561 External I/O Items	
Input (no-voltage contacts ¹⁾)	Output (open collector ¹⁾)
<ul style="list-style-type: none"> Measurement trigger ($\overline{\text{TRIG}}$) Print ($\overline{\text{PRINT}}$) Zero adjustment ($\overline{\text{OAdj}}$) Calibrate ($\overline{\text{CAL}}$) Manual comparator ($\overline{\text{MANU}}$) Load panel settings (7 bits) ($\overline{\text{LOAD0}}$ to $\overline{\text{LOAD6}}$) 	<ul style="list-style-type: none"> End-of-Measurement ($\overline{\text{EOM}}$) Measurement-in-progress ($\overline{\text{INDEX}}$) Comparator results ($\overline{\text{R-Hi}}$, $\overline{\text{R-IN}}$, $\overline{\text{R-Lo}}$, $\overline{\text{V-Hi}}$, $\overline{\text{V-IN}}$, $\overline{\text{V-Lo}}$, $\overline{\text{PASS}}$, $\overline{\text{FAIL}}$²) Measurement error ($\overline{\text{ERR}}$) General-purpose output ($\overline{\text{OUT1}}$ to $\overline{\text{OUT9}}$) (only 3561)

¹ The input and output signals of the BT3563 and BT3562 are isolated via photocouplers.

EXT I/O Connectors (BT3563 and BT3562, accessories not supplied)

Installed connector (HiTester side): 37-pin D-SUB accepts #4-40 screws
 Mating connectors: DC-37P-ULR (solder type) or DCSP-JB37PR (welded type) from Japan Aviation Electronics Industry, Ltd., or equivalent

EXT I/O Connectors (3561, accessories not supplied)

Installed connector (HiTester side): 57RE-40360-730B (D29) (DDK)
 Mating connectors: 57-30360 (DDK), RC30-36P (Hirose Electric Co., Ltd.), or equivalent

BT3563-01 and BT3562-01 Rear Panel

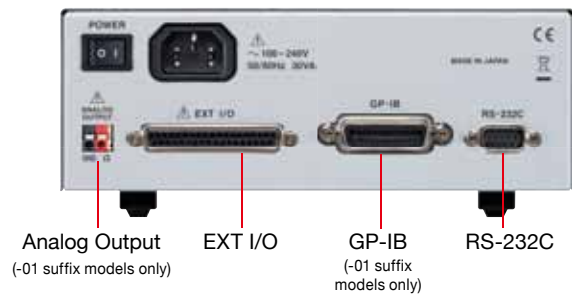

3561-01 Rear Panel

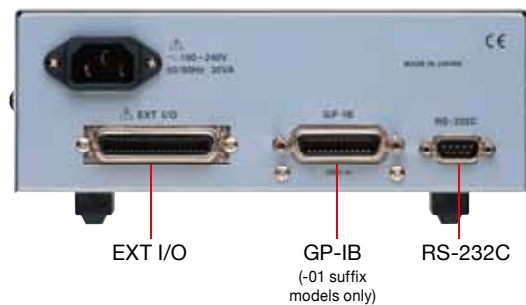

BT3563 and BT3562 External I/O Timing Chart

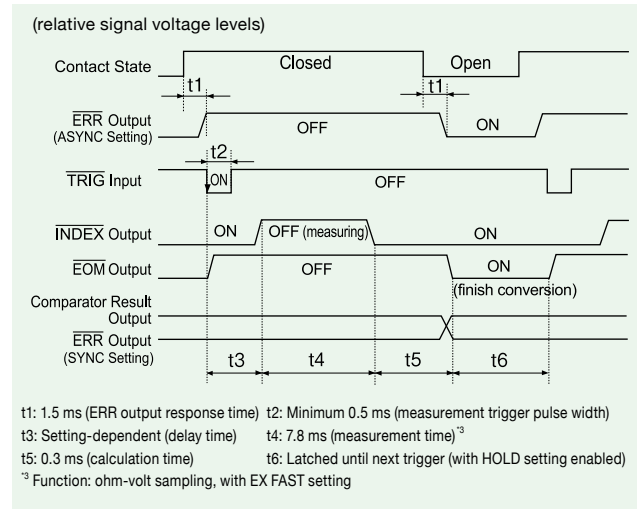

Comparator Functions

Judges Resistance & Voltage Simultaneously

Resistance and voltage can be simultaneously judged Hi/IN/Lo by independent comparators. Judgment results are provided on the display, beeper, and external I/O. The display allows confirming both results at a glance.



Resistance comparator settings



Composite Judgment Result Output

External I/O provides both separate and combined outputs of resistance and voltage judgment results, so composite results can be monitored.

Alternative Setting Methods

Set judgment thresholds by specifying high/low (Hi/Lo) values or by specifying a standard value and deviation (%).

Manual Comparator

Comparator judgments can be executed only when required, supporting flexible control by footswitch or PLC.

Dual Beep Tones

Different beep tones distinguish IN and Hi/Lo judgments. Both tones can be independently enabled or disabled.

Multiple Recording Methods

■ Analog Output (BT3563-01 and BT3562-01 only)

The BT3563-01 and BT3562-01 provide analog output of resistance measurement values. This is convenient for combining recorded data from multiple locations or of various data types, such as for logging long-term measurements and for fuel cell evaluation.

Output contents	Measured resistance (displayed value)
Output rate	0 to 3.1 V DC (corresponding to displayed value of 0 to 31000)
Resolution	12 bits
Response time	10 ms



■ PC Application Program

Measurement data can be transferred to a PC for importing to a spreadsheet program or storage as CSV files. Interval and manual measurements can be triggered by a keystroke or external trigger signal.

Download the PC application program from our website:

<http://www.hioki.com/>

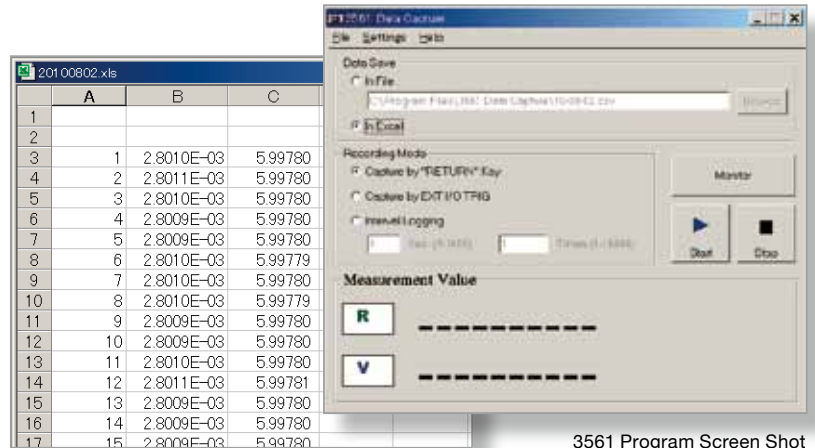

Excel Import Example

3561 Program Screen Shot

■ Data Printing

Measurement values, and those including judgment results and statistical calculation results can be printed using an RS-232C-compatible printer.

● Interval Printing

Elapsed time and measurement values can be printed over a specified interval. The interval can be set from 1 to 3,600 seconds.

● Requirement specification (printer)

The requirements for a printer to be connected to the instrument are as follows. Confirm compatibility and make the appropriate settings on the printer before connecting it to the instrument.

Interface	: RS-232C		BT3563/BT3562/3561 (9-pin) Connector		
Characters per line	: At least 40				
Communication speed	: 9600 bps				
Data bits	: 8				
Parity	: none				
Stop bits	: 1				
Flow control	: none				

Function	Signal name	Pin
Receive Data	R x D	2
Transmit Data	T x D	3
Signal or Common Ground	GND	5

ASCII data will be sent from the BT3563/BT3562/3561. Please use a printer that can output plain text

Printout Examples

```

1 2.5375mOhm, 4.70056 V
2 - 0.9730mOhm, 4.70055 V
3 0.F., 0.F.
4 -----
5 15.039 Ohm, - 50.254 V
6 200.12 Ohm, 11.3176 V
7 2.9984kOhm, -11.3099 V
8 0.1615 Ohm, -4.70054 V
9 0.166 Ohm, - 4.7006 V
10 0.16 Ohm, - 4.700 V
    
```

Measurement Values

```

50 5.033 Ohm Hi, 1.60427 V
51 5.033 Ohm Hi, -0.00001 V
52 17.655mOhm IN
53 18.354mOhm Hi
54 15.322mOhm Lo
    
```

Measurement Values and Judgment Results

```

*** RESISTANCE ***
Number      85
Valid       85
Average     13.06 Ohm
Max         13.78 mOhm ( 74)
Min         12.10 mOhm ( 3)
Sn          0.38mOhm
Sn-1        0.38mOhm
Op          1.32
OpK         0.09
Comp Hi     40
Comp IN     45
Comp Lo     0

*** VOLTAGE ***
Number      85
Valid       85
Average     10.0074 V
Max         10.0197 V ( 57)
Min         9.9938 V ( 31)
Sn          0.0068 V
Sn-1        0.0068 V
Op          0.35
OpK         0.32
Comp Hi     10
Comp IN     59
Comp Lo     16
    
```

Statistical Calculations and Judgment Results

■ Specifications

● BT3563, BT3562 and 3561 Specifications

Measurement types	Resistance and voltage
Resistance measurement method	Four-terminal AC (1-kHz) method
Functions	ΩV, Ω and V
Rated voltage	[BT3563(-01)] ±300V DC rated input voltage ±300V DC maximum rated voltage to ground [BT3562(-01)] ±60V DC rated input voltage ±70V DC maximum rated voltage to ground [3561(-01)] ±22V DC rated input voltage ±70V DC maximum rated voltage to ground
Input resistance	[BT3563(-01) and BT3562(-01)] 3mΩ/30mΩ/300mΩ ranges: Approx. 90kΩ 3Ω/30Ω/300Ω/3000Ω ranges: Approx. 1MΩ [3561(-01)] Approx. 1MΩ
Sampling rate	Four steps – Extra Fast, Fast, Medium or Slow
Response time	[BT3563(-01) and BT3562(-01)] Approx. 10 ms for measurements Note: Response time depends on reference values and the measurement object. [3561(-01)] Approx. 3 ms for measurements Note: Response time depends on reference values and the measurement object.
Total measurement time	Sampling time + Response time

Zero-adjustment	1000-count range (both resistance and voltage)
Triggering	Internal or external
Delay time	On/off, 0 to 9.999 seconds
Averaging samples	On/off, 2 to 16 samples
Statistical calculations	Total data count; valid data count; maximum, minimum and average values; standard deviation; population standard deviation and process capability indices
Measurement value output function	Measurement values are output via RS-232C upon trigger input
Measurement value memory	Up to 400 measurements
Panel save/load	Up to 126 configuration settings Save Frequently Used Settings in Memory: Measurement function, resistance measurement range, auto-range setting, zero-adjust setting data, sampling rate, trigger source, delay setting, averaging and comparator settings, statistical calculation setting, display switching and key-lock.
Analog Output	[BT3563-01 and BT3562-01 only] Measured resistance (displayed value, from 0 to 3.1 V DC)
External interface	External I/O, RS232C (9600, 19200 or 38400 bps), Printer RS-232C (all models), GP-IB (Model BT3563-01, BT3562-01 and 3561-01 only)
Other functions	Over-range display, measurement error detection, self-calibration, dual comparators, key-lock

● BT3563, BT3562 and 3561 General Specifications

Operating temperature & humidity	0 to 40°C, 80% rh or less (non-condensating)
Storage temperature & humidity	-10 to 50°C, 80% rh or less (non-condensating)
Guaranteed accuracy temperature & humidity	23°C ±5°C, 80% rh or less (non-condensating)
Operating conditions	Indoors, below 2000 m ASL
Rated supply voltage	100 to 240 V AC (auto-selecting)
Rated supply frequency	50/60 Hz
Rated power consumption	30 VA

Insulation withstand potential	[BT3563(-01), BT3562(-01)] 1.39 kV AC for 15 s (with 10 mA cut-off current) between all mains supply terminals and protective ground terminal 2.224 kV AC for 15 s (with 1 mA cut-off current) between all measurement jacks and interfaces 1.39 kV AC for 15 s (with 1 mA cut-off current) between all measurement jacks and protective ground terminal [3561(-01)] 1.69 kV AC for 15 s (with 10 mA cutoff current) between all mains supply terminals and protective ground, interfaces, and measurement jacks
Dimensions	Approx. 215W × 80H × 295D mm (without projections)
Mass	Approx. 2.4 kg
Accessories	Power Cord (1)
Applicable Standards	Safety EN61010-1 EMC EN61326 EN61000-3-2 EN61000-3-3

● BT3563 and BT3562

[Sampling Times]

Function		EX.FAST	FAST	MEDIUM	SLOW
ΩV	(50Hz)	8ms	24ms	84ms	259ms
	(60Hz)			70ms	253ms
Ω	(50Hz)	4ms	12ms	42ms	157ms
	(60Hz)			35ms	150ms
V	(50Hz)	4ms	12ms	42ms	157ms
	(60Hz)			35ms	150ms

Items in the parentheses () indicate supply frequency settings; Tolerance: ±5 ms

● 3561

[Sampling Times]

Function		EX.FAST	FAST	MEDIUM	SLOW
ΩV	(50Hz)	7ms	23ms	83ms	258ms
	(60Hz)			69ms	252ms
Ω	(50Hz)	4ms	12ms	42ms	157ms
	(60Hz)			35ms	150ms
V	(50Hz)	4ms	12ms	42ms	157ms
	(60Hz)			35ms	150ms

Items in the parentheses () indicate supply frequency settings; Tolerance: ±5 ms

■ Measurement Ranges and Accuracy (Guaranteed Accuracy Period: 1 year)

● BT3563, BT3562 and 3561 Conditions of Guaranteed Accuracy

Temperature & humidity:

23 °C ±5 °C, 80% rh or less (non-condensating)

Zero-adjustment: After executing zero-adjustment

Warm-up time: At least 30 min.

Self-calibration:

Unless using SLOW sampling, execute self-calibration after warm-up and restrict temperature fluctuations to within ±2 °C after calibration.

● About Accuracy

Accuracy is calculated from the reading error (±% rdg.) determined by the measurement value and range, and the digit error (± dgt.).

Calculation Example

Measurement value: 1 Ω, Measurement range: 3 Ω

Specified accuracy (from table below): ±0.5% rdg., ±5 dgt.

(A) Reading error (±% rdg.): 1 [Ω] × 0.5% = ±0.005 [Ω]

(B) Digit error (± dgt.): ±5 dgt. = ±0.0005 [Ω] (at 0.0001 Ω resolution)

(C) Total error (A + B): ±0.0055 [Ω]

Applying total error (C) to the measurement value of 1 Ω gives an error limit of 0.9945 to 1.0055 Ω.

● BT3563 and BT3562 [Resistance Measurement]

Range	3mΩ	30mΩ	300mΩ	3Ω	30Ω	300Ω	3000Ω
Maximum display Value	3.1000mΩ	31.000mΩ	310.00mΩ	3.1000Ω	31.000Ω	310.00Ω	3100.0Ω
Resolution	0.1μΩ	1μΩ	10μΩ	100μΩ	1mΩ	10mΩ	100mΩ
Measurement Current ^{*1}	100mA	100mA	10mA	1mA	100μA	10μA	10μA
Measurement Current Frequency	1kHz ±0.2Hz						
Accuracy ^{*2}	±0.5%rdg.±10dgt.		±0.5%rdg. ±5dgt.				
Temperature coefficient	(±0.05%rdg. ±1dgt.) / °C		(±0.05%rdg. ±0.5dgt.) / °C				
Open-Circuit Voltage	25V peak		7V peak	4V peak			

*1 Measurement current accuracy is ±10%.

*2 30mΩ to 3000Ω ranges: Add ±3 dgt. for EX FAST, or ±2 dgt. for FAST and MEDIUM

3mΩ range: Add ±30 dgt. for EX FAST, or ±10 dgt. for FAST, or ±5 dgt. for MEDIUM

[Voltage Measurement]

Range	6V	60V	300V (only BT3563)
Maximum display Value	±6.00000V	±60.0000V	±300.000V
Resolution	10μV	100μV	1mV
Accuracy ^{*3}	±0.01%rdg. ±3dgt.		
Temperature coefficient	(±0.001%rdg. ±0.3dgt.) / °C		

*3 Add ±3 dgt. for EX FAST, or ±2 dgt. for FAST and MEDIUM

● 3561 [Resistance Measurement]

Range	300mΩ	3Ω
Maximum display Value	310.00mΩ	3.1000Ω
Resolution	10μΩ	100μΩ
Measurement Current ^{*4}	10mA	1mA
Measurement Current Frequency	1kHz ±0.2Hz	
Accuracy ^{*5}	±0.5%rdg. ±5dgt.	
Temperature coefficient	(±0.05%rdg. ±0.5dgt.) / °C	
Open-Circuit Voltage	7V Peak	

*4 Measurement current accuracy is ±10%.

*5 Add ±3 dgt. for EX FAST, or ±2 dgt. for FAST and MEDIUM

*6 Add ±3 dgt. for EX FAST, or ±2 dgt. for FAST and MEDIUM

● 3561 [Voltage Measurement]

Range	20V
Maximum display Value	±19.9999V
Resolution	0.1mV
Accuracy ^{*6}	±0.01%rdg. ±3dgt.
Temperature coefficient	(±0.001%rdg. ±0.3dgt.) / °C

■ Option Configurations

● Main unit



BATTERY HiTESTER BT3563

BT3563-01 (with GP-IB and analog output)

BATTERY HiTESTER BT3562

BT3562-01 (with GP-IB and analog output)

BATTERY HiTESTER 3561

3561-01 (with GP-IB)

- Measurement leads are not included. Purchase the appropriate lead option for your application separately.
- The male (system side) of the EXT I/O connector is also available. Please inquire with your HIOKI distributor.

● Options (measurement leads)

Measurement lead (for measuring high voltage batteries with Models BT3563 and BT3562)

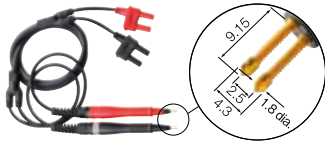

PIN TYPE LEAD L2100

A:300 mm, B:172 mm, L:1400 mm
for high voltage battery measurements, 600 V
DC max., BT3563 and BT3562 only

Zero adjustment board (for L2100 only)



ZERO ADJUSTMENT BOARD 9454
for L2100 only

Cannot be used for zero adjusting the 9770 and 9771 Pin Type Leads

About probe length

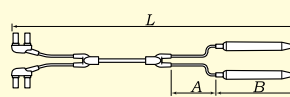

A: between junction and probe
B: probe length
L: between connector and probe tip

Measurement leads (for measuring batteries up to 60 V with BT3563, BT3562, or 3561)



CLIP TYPE LEAD 9287-10
A:130 mm, B:83 mm, L:1100 mm, DC70V



FOUR TERMINAL LEAD 9453
A:280 mm, B:118 mm, L:1360 mm, DC60V



Not CE marked.
29mm diameter
LARGE CLIP TYPE LEAD 9467
A:300 mm, B:116 mm, L:1360 mm, DC50V

Mainly for Small Secondary Batteries (with very small terminals)

1.8 mm dia. single-axis type for measuring small electrodes

0.2 mm parallel pyramid-type pins for measuring at thru holes and sub-millimeter objects

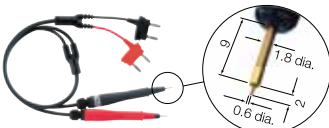

PIN TYPE LEAD 9770 9770 tip shape
A:260 mm, B:140 mm, L:850 mm,
DC70V

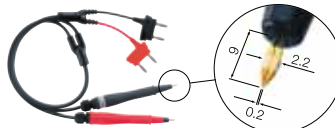

PIN TYPE LEAD 9771 9771 tip shape
A:260 mm, B:138 mm, L:850 mm,
DC70V

Measurement leads (3561 only)



CLIP TYPE LEAD 9452
A:220 mm, B:197 mm, L:1360 mm

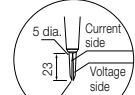

9452 tip shape

Measurement leads (for maximum precision, 3561 only)



PIN TYPE LEAD 9455
A:260 mm, B:136 mm, L:890 mm

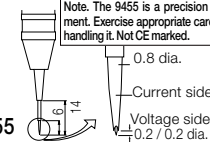

9455 pin (enlarged)

Note: The 9455 is a precision instrument. Exercise appropriate care when handling it. Not CE marked.

● Options (Interface Cables)

Interface (RS-232C and GP-IB) Connection cables



RS-232C CABLE 9637
9- to 9-pin crossover, 1.8m



RS-232C CABLE 9638
9- to 25-pin crossover, 1.8m



GP-IB CONNECTOR CABLE 9151-02
2m

Note: Company names and Product names appearing in this catalog are trademarks or registered trademarks of various companies.

HIOKI

HIOKI E. E. CORPORATION

HEADQUARTERS:

81 Koizumi, Ueda, Nagano, 386-1192, Japan
TEL +81-268-28-0562 FAX +81-268-28-0568
http://www.hioki.com / E-mail: os-com@hioki.co.jp

HIOKI (Shanghai) SALES & TRADING CO., LTD.:
TEL +86-21-63910090 FAX +86-21-63910360
http://www.hioki.cn / E-mail: info@hioki.com.cn

DISTRIBUTED BY

HIOKI INDIA PRIVATE LIMITED:
TEL +91-124-6590210 FAX +91-124-6460113
E-mail: hioki@hioki.in

HIOKI SINGAPORE PTE. LTD.:
TEL +65-6634-7677 FAX +65-6634-7477
E-mail: info@hioki.com.sg

Find Quality Products Online at:

www.GlobalTestSupply.com

sales@GlobalTestSupply.com