

Megohmmeter Models 6526, 6532 and 6534

User Manual
ENGLISH



Measure up

AEMC[®]
INSTRUMENTS
CHAUVIN ARNOUX GROUP

Find Quality Products Online at:

www.GlobalTestSupply.com

sales@GlobalTestSupply.com

Copyright © Chauvin Arnoux®, Inc. d.b.a. AEMC® Instruments. All rights reserved.

No part of this documentation may be reproduced in any form or by any means (including electronic storage and retrieval or translation into any other language) without prior agreement and written consent from Chauvin Arnoux®, Inc., as governed by United States and International copyright laws.

This documentation is provided “as is,” without warranty of any kind, express, implied, or otherwise. Chauvin Arnoux®, Inc. has made every reasonable effort to ensure that this documentation is accurate; but does not warrant the accuracy or completeness of the text, graphics, or other information contained in this documentation. Chauvin Arnoux®, Inc. shall not be liable for any damages, special, indirect, incidental, or inconsequential; including (but not limited to) physical, emotional or monetary damages due to lost revenues or lost profits that may result from the use of this documentation, whether or not the user of the documentation has been advised of the possibility of such damages.

Chauvin Arnoux®, Inc, AEMC®, and DataView® are registered trademarks of AEMC® Instruments.

Find Quality Products Online at:













www.GlobalTestSupply.com

sales@GlobalTestSupply.com

Thank you for purchasing the **Megohmmeter Model 6526, 6532, or 6534.**

For best results from your instrument:

- Read these operating instructions carefully
- Comply with the precautions for use

	WARNING, risk of DANGER! The operator must refer to these instructions whenever this danger symbol appears
	WARNING, risk of electric shock. The voltage applied to parts marked with this symbol may be hazardous
	Equipment is protected by double insulation
	The voltage on the terminals must not exceed 700V
	Ground/Earth
	Battery
	Information or useful tip
	Remote test probe
	The product is recyclable in accordance with standard ISO14040
	This instrument exceeds regulatory requirements with respect to recycling and reuse
	Indicates conformity with European directives, in particular LVD and EMC
	Indicates that, in the European Union, the instrument must undergo selective disposal in compliance with Directive WEEE 2002/96/EC. This instrument must not be treated as household waste

Definition of Measurement Categories (CAT)

- **CAT IV** corresponds to measurements taken at the source of low-voltage installations.
Example: power feeders and protection devices.
- **CAT III** corresponds to measurements on building installations.
Example: distribution panel, circuit-breakers, machines or fixed industrial devices.
- **CAT II** corresponds to measurements taken on circuits directly connected to low-voltage installations.
Example: power supply to electro-domestic devices and portable tools.

PRECAUTIONS FOR USE

This instrument is compliant with safety standard IEC 61010-2-030, and the leads are compliant with IEC 61010-031, for voltages up to 600V in CAT IV or 1000V in CAT III.

Failure to observe the following safety instructions may result in electric shock, fire, explosion, and damage to the instrument and installation.

- Carefully read and understand all precautions for use.
- Be aware of all electrical hazards when using this instrument.
- Using this instrument other than as specified may compromise its user protection features.
- The safety of any system in which this instrument is incorporated is the responsibility of the integrator of the system.
- This instrument can be used on CAT IV installations, for voltages not exceeding 600V_{RMS} with respect to ground or 700V_{RMS} maximum between terminals.
- Do not use the instrument on networks whose voltage or category exceeds those specified in this manual.
- Observe all environmental conditions of use (see § 3).
- Except for voltage measurements, take no measurements on electrically “live” systems.
- Do not use the instrument if it appears damaged, incomplete, or poorly closed.
- Before each use, check the condition of the insulation on the leads, housing, and accessories. Any part on which the insulation is deteriorated (even partially) must be set aside for repair or scrapping.
- Using the instrument without its battery compartment cover may result in electric shock to the user.
- Before using your instrument, ensure it is completely dry.
- Use only the leads and accessories supplied. The use of leads (or other accessories) of a lower voltage rating or category limits the use of the instrument/leads (or accessories) combination to the lowest category and service voltage.
- When handling the leads, test probes, and alligator clips, keep your fingers behind the physical guards.
- Before removing the battery compartment cover, ensure all measurement leads and accessories are disconnected. Replace all batteries at once. Use alkaline batteries.
- Use personal protection equipment where appropriate.
- All troubleshooting and metrological checks must be done by competent, accredited personnel.

TABLE OF CONTENTS

1. INTRODUCTION	4
1.1 Receiving Your Shipment	4
1.2 Accessories	5
1.3 Replacement Parts	5
1.4 Description	5
1.4.1 Model 6526 (Front).....	6
1.4.2 Model 6532 (Front).....	7
1.4.3 Model 6534 (Front).....	8
1.5 Back of Instrument	9
1.6 Terminals	10
1.7 Function Buttons	10
1.8 LCD Display	11
2. OPERATION.....	12
2.1 Setting Up the Instrument.....	12
2.1.1 Configuration Settings	12
2.1.2 Bluetooth.....	13
2.1.3 Alarms	13
2.1.3.1 Activating/Deactivating the Alarm Function.....	13
2.1.3.2 Setting an Alarm Threshold.....	13
2.1.3.3 Viewing Alarms.....	14
2.1.4 Δ REL Function	14
2.1.5 HOLD Function	15
2.1.6 Backlighting.....	16
2.1.7 Standby Mode.....	16
2.2 Taking Measurements	16
2.2.1 Voltage Measurement	16
2.2.2 Insulation Measurement.....	18
2.2.2.1 TEST Button Operation.....	19
2.2.2.2 Timed Tests	19
2.2.2.3 Remote Control Probe (Optional).....	21
2.2.3 Continuity Measurement	21
2.2.3.1 Lead Compensation.....	22
2.2.3.2 Continuity Measuring	23
2.2.4 Resistance Measurement	24
2.2.5 Capacitance Measurement (Models 6526 and 6532).....	24
2.3 Recording Data	25
2.3.1 Recording a Measurement.....	25
2.3.2 Viewing Stored Recordings.....	26
2.3.3 Deleting Recordings.....	27
2.3.3.1 Deleting a Single Recording.....	27
2.3.3.2 Deleting All Recordings	27

3. TECHNICAL SPECIFICATIONS.....	28
3.1 General Reference Conditions	28
3.2 Electrical Specifications.....	28
3.2.1 Voltage Measurement	28
3.2.2 Frequency Measurement	28
3.2.3 Insulation Measurement.....	29
3.2.4 Continuity Measurement	31
3.2.5 Resistance Measurement	31
3.2.6 Capacitance Measurement (Models 6526 and 6532)	31
3.2.7 Timer	32
3.2.8 Storage Memory.....	32
3.2.9 Bluetooth.....	32
3.3 Operating Environment	32
3.3.1 Voltage Measurement	32
3.3.2 Insulation Measurement.....	33
3.3.3 Resistance and Continuity Measurement	34
3.3.4 Capacitance Measurement (Models 6526 and 6532)	34
3.4 Intrinsic Uncertainty and Operating Uncertainty.....	35
3.5 Power Supply	35
3.6 Environmental Conditions	35
3.7 Mechanical Specifications	35
3.8 Safety Standards.....	36
4. DATAVIEW SOFTWARE	37
4.1 Installing DataView	37
4.2 Megohmmeter Control Panel	38
4.3 Connecting to the Computer	38
4.3.1 Enabling Bluetooth on the Instrument.....	38
4.3.2 Pairing the Instrument to the Computer	39
4.3.3 Connecting the Instrument with the Control Panel.....	39
5. MAINTENANCE AND TROUBLESHOOTING.....	40
5.1 Maintenance.....	40
5.1.1 Cleaning.....	40
5.1.2 Replacing the Batteries	40
5.2 Troubleshooting.....	42
5.2.1 Errors	42
5.2.1.1 Voltage present before an insulation measurement.....	42
5.2.1.2 Range exceeded during an insulation measurement.....	42
5.2.1.3 Voltage present during a continuity, resistance, or capacitance measurement (Models 6526 and 6532).....	43
5.2.1.4 Memory full.....	43
5.2.2 Resetting the Instrument.....	43
5.3 Repair and Calibration.....	44
5.4 Technical and Sales Assistance	44
5.5 Limited Warranty	45
5.6 Warranty Repairs.....	45

1. INTRODUCTION

1.1 Receiving Your Shipment

Upon receiving your megohmmeter product package, ensure the contents are consistent with the packing list. Notify your distributor of any missing items. If the equipment appears to be damaged, file a claim immediately with the carrier and notify your distributor at once, providing a detailed description. Save the damaged packing container to substantiate your claim.

Ordering Information:

Megohmmeter Model 6526.....	Cat. #2155.53
Megohmmeter Model 6532.....	Cat. #2155.54
Megohmmeter Model 6534.....	Cat. #2155.55

Shipping Contents:



(1) of the following:

- Megohmmeter Model 6526 - Cat. #2155.53
- Megohmmeter Model 6532 - Cat. #2155.54
- Megohmmeter Model 6534 - Cat. #2155.55



(1) Soft Carrying Pouch - Cat. #2119.02
7.75 x 9.25 x 2.75"



(2) Color-coded (Red/Black) Test Leads with Alligator Clips and (1) Black Test Probe



(2) Color-coded Grip Probes - Cat. #2152.26
(Models 6532 & 6534 Only)



USB Stick with
DataView® Software and User Manual

Also includes 6 AA batteries

1.2 Accessories

Megohmmeter Test Probe	Cat. #2155.75
Case - Field Case (Waterproof).....	Cat. #2155.77
Continuity Probe	Cat. #2138.54
Probe – Red test probe (1000V Cat IV, 15A, UL).....	Cat. #5000.31

1.3 Replacement Parts

Carrying Pouch for Cable Tester, Megohmmeters, Multimeters, etc.	Cat. #2119.02
Probe - Set of 2, Color-coded (Red/Black) Grip Probes.....	Cat. #2152.26
Probe – Black test probe (1000V Cat IV, 15A, UL).....	Cat. #5000.30
Lead - Set of 2, 5 ft silicone color-coded (red/black) with 4mm straight/right banana plugs (Rated 1000V, CAT IV, UL).....	Cat. #5000.94
Clip - Safety Alligator - Black (1000V CAT IV, 15A, UL V2)	Cat. #5000.99
Clip - Safety Alligator - Red (1000V CAT IV, 15A, UL V2)	Cat. #5100.00

For accessories and replacement parts, visit our store at www.aemc.com.

1.4 Description

The Megohmmeters Models 6526, 6532, and 6534 are portable measuring instruments with digital displays. They are powered by batteries. These instruments can check the safety of electrical installations. For example, they can be used to test new installations before they are powered up, check an existing installation in a power-off condition, or troubleshoot an installation. The Model 6532 is designed for telecommunication applications such as testing telephone lines. The Model 6534 is designed for applications in the electronics industry, including testing the immunity of walls and floors to electrostatic discharges (ESD). Features include:

	Model 6526	Model 6532	Model 6534
Insulation test voltages	50, 100, 250, 500, and 1000V	50 and 100V	10, 25, 100, 250, and 500V
Insulation resistance	10kΩ to 200GΩ	10kΩ to 20GΩ	2kΩ to 50GΩ
PI and DAR ratios calculation	✓	✓	
Continuity measurement	✓	✓	✓
Resistance measurement	✓	✓	✓
Programmable alarms	✓	✓	✓
Frequency measurement	✓	✓	
Capacitance measurement	✓	✓	
Distance measurement		✓	
Data storage	✓	✓	✓
Bluetooth communication	✓	✓	✓

1.4.1 Model 6526 (Front)

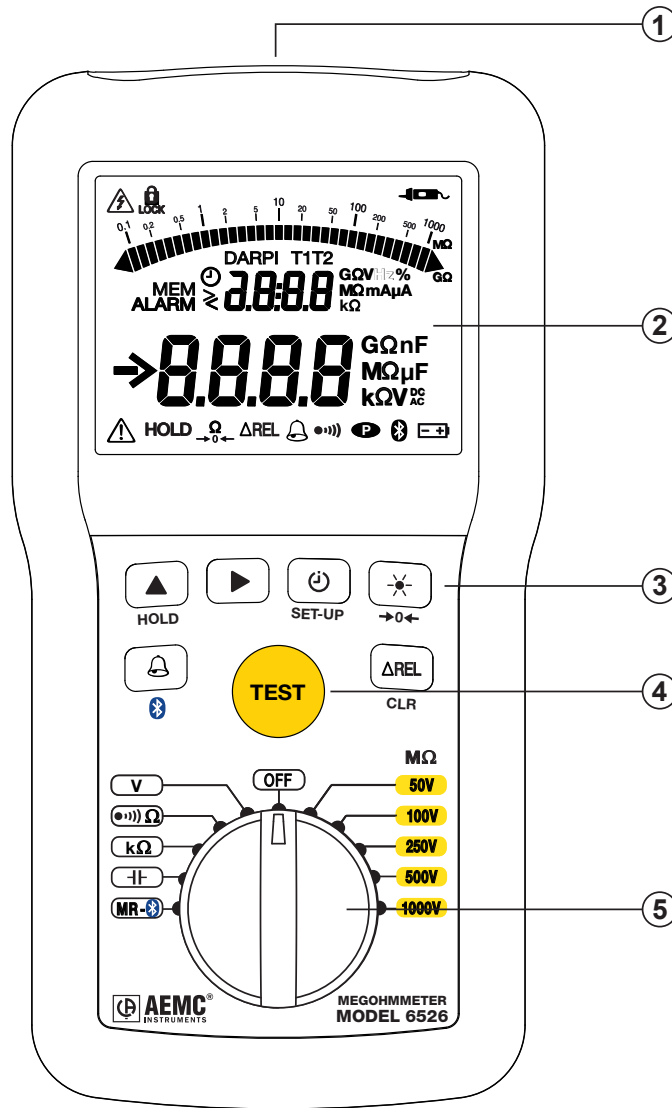

Figure 1

1. Input terminals
2. Blue backlit LCD
3. Six function buttons (see § 1.7)
4. **TEST** button to start insulation measurements (see § 2.2.2.1)
5. Eleven-position rotary switch to choose the function or to turn the instrument OFF

1.4.2 Model 6532 (Front)

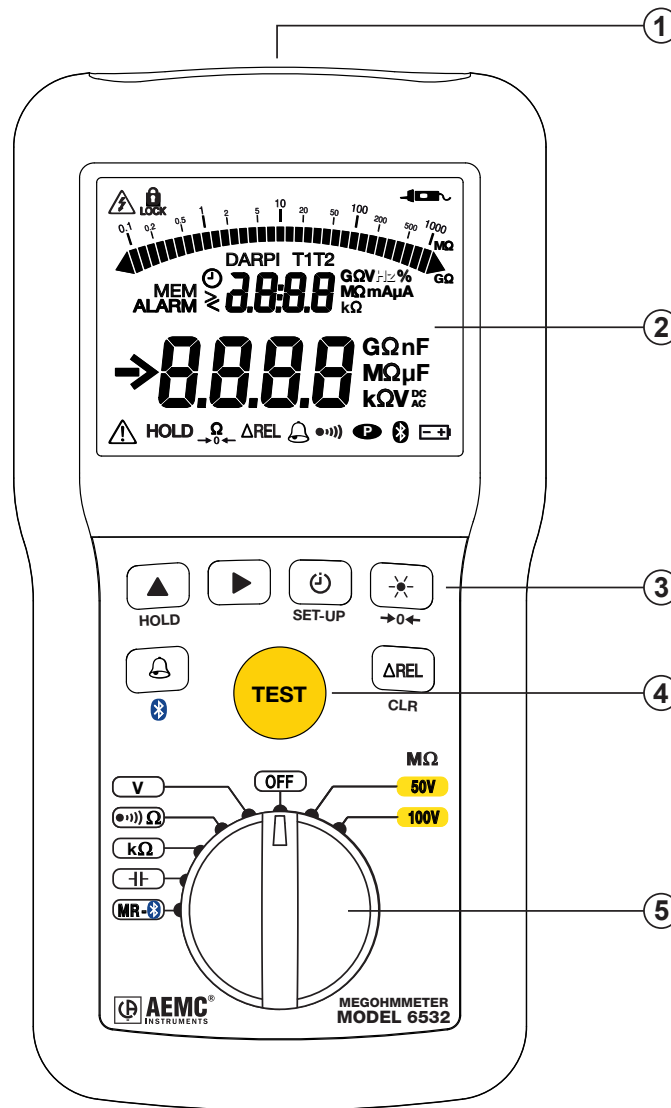

Figure 2

1. Input terminals
2. Blue backlit LCD
3. Six function buttons (see § 1.7)
4. **TEST** button to start insulation measurements (see § 2.2.2.1)
5. Eight-position rotary switch to choose the function or to turn the instrument OFF

1.4.3 Model 6534 (Front)

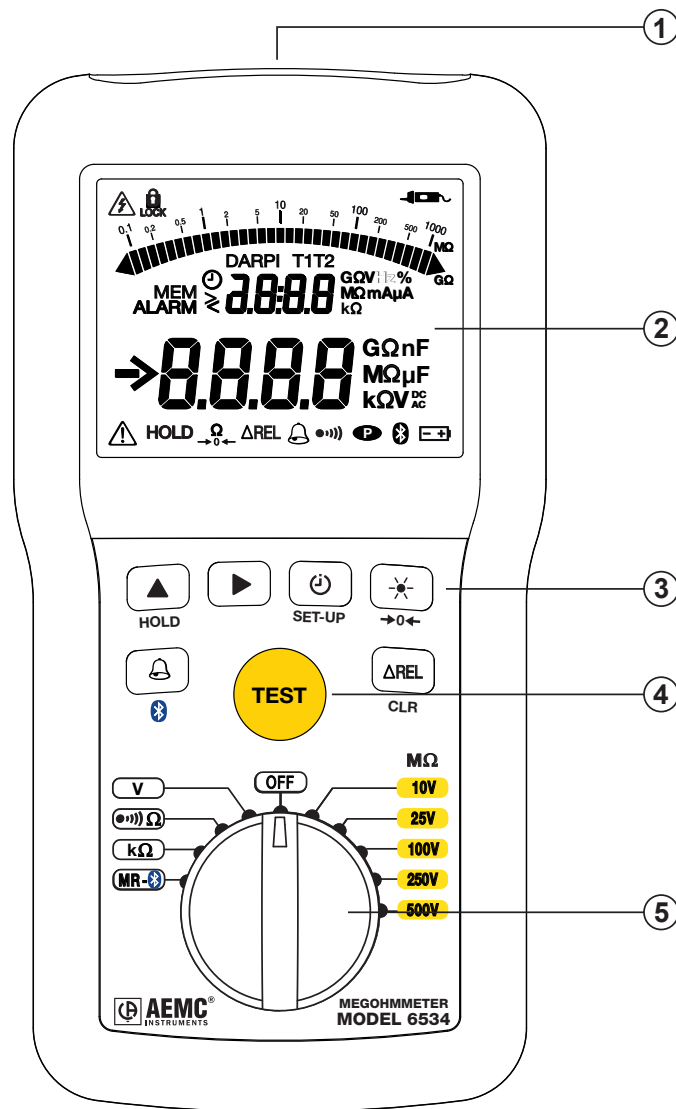

Figure 3

1. Input terminals
2. Blue backlit LCD
3. Six function buttons (see § 1.7)
4. **TEST** button to start insulation measurements (see § 2.2.2.1)
5. Ten-position rotary switch to choose the function or to turn the instrument OFF

1.5 Back of Instrument

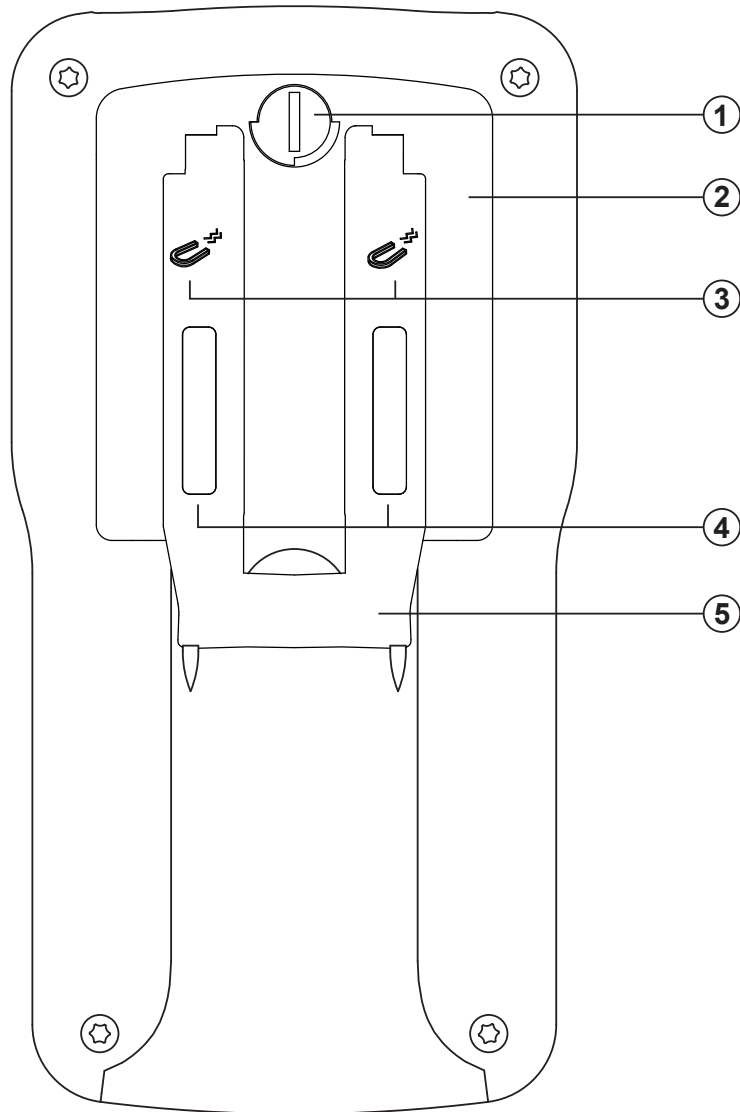

Figure 4

1. Captive quarter-turn screw
2. Battery compartment cover
3. Mounting magnets, moulded into instrument case
4. Non-skid pads
5. Stand

1.6 Terminals

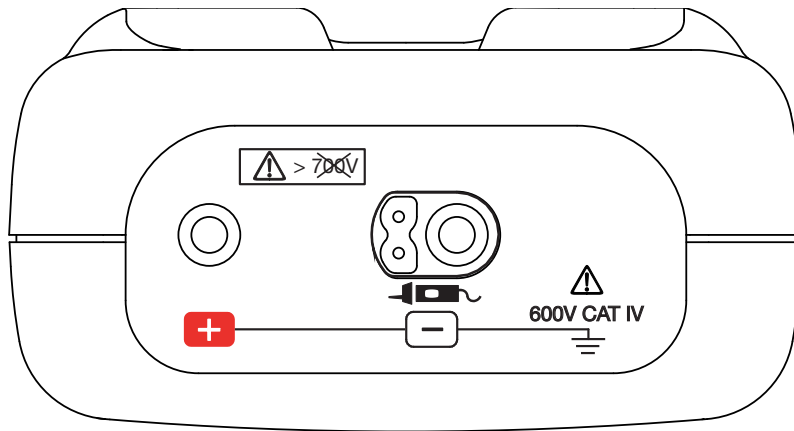

Figure 5

The instrument has one positive (+) terminal and one negative (-) terminal. The negative terminal also supports the remote probe accessory (see § 2.2.2.3).

1.7 Function Buttons

In general, each button has two functions. One is marked on the button, and is enabled via a short press. The second function is marked under the button, and is enabled by a long (>2 seconds) press.

BUTTON	DESCRIPTION
	Selects the Lock, π , PI , and DAR functions (§ 2.2.2.2).
	Toggles backlighting ON and OFF (§ 2.1.6).
HOLD	Freezes/unfreezes the displayed measurement on the LCD (§ 2.1.5).
SET-UP	Accesses the instrument's setup parameters and information (§ 2.1.1).
	Applies lead compensation in continuity testing (§ 2.2.3.1).
	Activates/deactivates alarms (§ 2.1.3).
	The and buttons allow you to: <ul style="list-style-type: none"> ■ Modify the display and program the durations of insulation measurements (§ 2.2.2.2). ■ Choose the continuity test current (§ 2.2.3). ■ Program the alarm thresholds (§ 2.1.3).
ΔRel	Displays the difference between the present measurement and a stored reference measurement (§ 2.1.4).
MEM	Records measurements (§ 2.3).
CLR	Erase recorded measurements (§ 2.3.3).
	Enable Bluetooth wireless communication (§ 2.1.2).

1.8 LCD Display

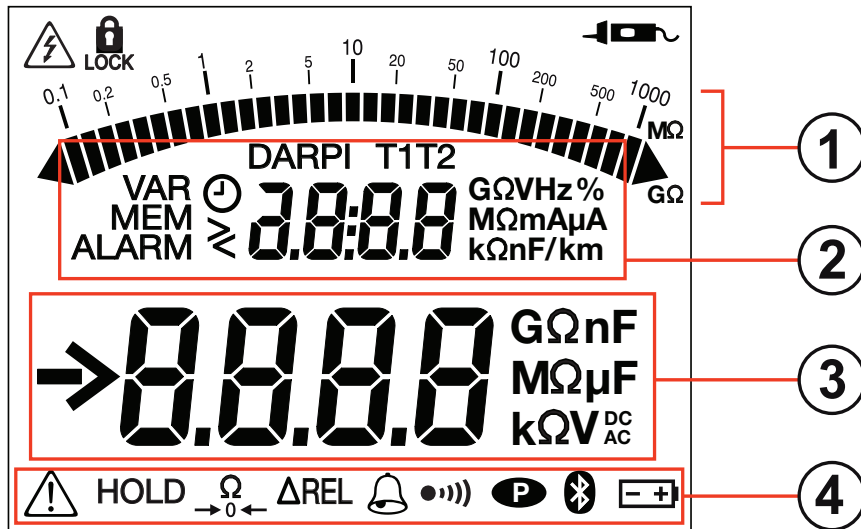



Figure 6

1. Logarithmic bar graph displays insulation measurements
2. Secondary display area
3. Main display area
4. Icons/indicators

When the measured value is below the minimum, the instrument displays - - - - .

When measuring voltage, if the reading falls outside the range defined by the positive and negative limits, the instrument displays **OL** or **- OL**.

2. OPERATION

 Except when measuring voltage, all measurements must be made on powered-off systems. Therefore check to ensure there is no voltage on the system under test before making a non-voltage measurement. When the rotary switch is set to the voltage or an insulation testing position, the instrument measures and displays any voltage present at the input terminals prior to the user pressing the test button.



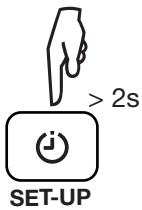

2.1 Setting Up the Instrument

2.1.1 Configuration Settings



A >2 second press of the SET-UP button enables you to change configuration settings on the instrument. You can then use the ◀ and ▶ buttons to scroll through and modify parameters.

In Set-Up mode, the ▲ button performs the following functions:

1 st press on ▲		The alarm buzzer is active. To deactivate it: <ol style="list-style-type: none"> 1. Press ▶. On will blink to indicate it is selected. 2. Press ▲ to change the setting to OFF. 3. Press ▶ to validate the change. <p>The ●●● symbol disappears from the display when you exit Set-Up. Note that this setting reverts to On when you turn OFF the instrument.</p>
2 nd press on ▲		Automatic switching to standby mode is activated. To deactivate it: <ol style="list-style-type: none"> 1. Press ▶ to select OFF (the setting blinks). 2. Press ▲ to change the setting to On. 3. Press ▶ to validate the change. <p>The P symbol appears on the display when you exit Set-Up. Note that this setting reverts to OFF when you turn OFF the instrument.</p>
3 rd press on ▲		Displays the instrument model number.
4 th press on ▲		Displays the instrument firmware version.
5 th press on ▲		Displays the instrument hardware version.
6 th press on ▲		Return to the first press.

2.1.2 Bluetooth

The instrument includes built-in Bluetooth class II capability. This enables you to connect the instrument to a computer and then communicate with it via the DataView Megohmmeter Control Panel software (see § 4.3).

Connecting the instrument to a computer is a three-step process:



1. Enable Bluetooth on the instrument (§ 4.3.1).
2. Pair the instrument to the computer using Bluetooth (§ 4.3.2).
3. Connect the instrument to the computer through the DataView Megohmmeter Control Panel (§ 4.3.3).

2.1.3 Alarms

The instrument includes an alarm function that sounds an audible buzzer when a defined alarm condition is measured.

2.1.3.1 Activating/Deactivating the Alarm Function



The alarm is available in insulation, resistance, and continuity measurement modes. Pressing the  button activates the alarm. The  symbol is displayed, along with the threshold value.

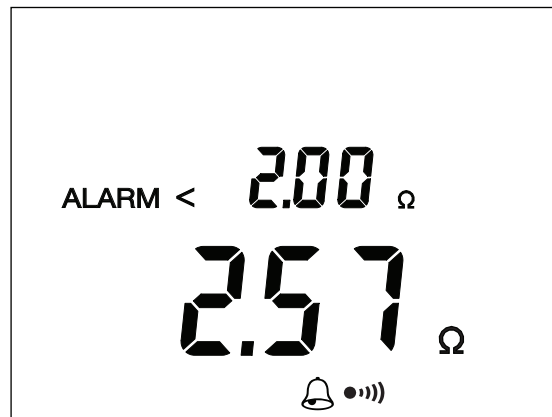

To turn OFF the alarm buzzer while it is sounding, press the **HOLD** button.

To deactivate an active alarm function, press the  button.

2.1.3.2 Setting an Alarm Threshold

While  is displayed indicating the alarm function is active, you can change the alarm threshold by pressing the **▲** button (except during insulation measurements). For each testing mode, there are three pre-defined threshold values:

- Continuity: < 2Ω, <1Ω and <0.5Ω
- Resistance: >50kΩ, >100kΩ and >200kΩ

- Insulation:
 - 10V : <10k Ω , <20k Ω and <40k Ω
 - 25V : <25k Ω , <50k Ω and <100k Ω
 - 50V : <50k Ω , <100k Ω and <200k Ω
 - 100V : <100k Ω , <200k Ω and <400k Ω
 - 250V : <250k Ω , <500k Ω and <1M Ω
 - 500V : <500k Ω , <1M Ω and <2M Ω
 - 1000V : <1M Ω , <2M Ω and <4M Ω

In each measurement mode, the third threshold can be replaced by a user-defined value. To do this:

1. Press the ► button while the threshold value is displayed.
2. The > symbol starts blinking; you can change it to < by pressing the ▲ button. This symbol indicates the direction of the alarm threshold: < for a low threshold and > for a high threshold.
3. To change the threshold setting, press the ► button to navigate to the first digit, and then use the ▲ button to change its value.
4. Use the ► and ▲ buttons to select and change the other digits in the threshold value, as well as the units of measurement.
5. When finished setting the threshold, press the ► button to validate the setting.

2.1.3.3 Viewing Alarms

When the measurement is below a low alarm threshold or above a high alarm threshold, the instrument emits a continuous audible signal and the LCD indicates the threshold crossed:

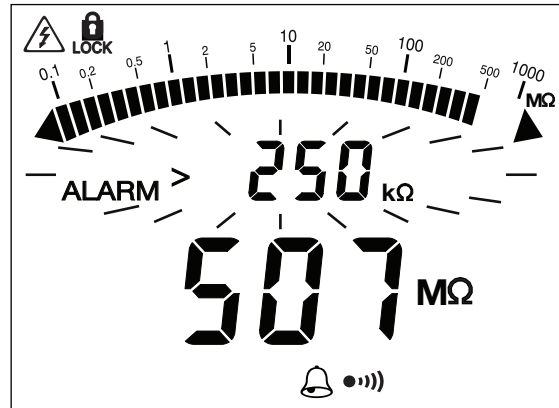
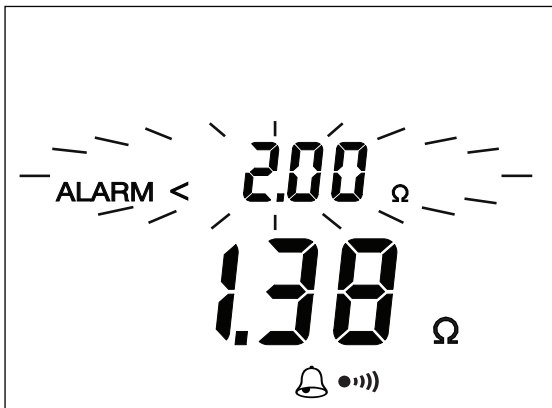

When checking continuity, this enables you to determine whether or not the continuity measurement is less than 2 Ω simply by listening, without looking at the display. You can similarly check insulation quality.

2.1.4 Δ REL Function



For an insulation, resistance, or capacitance measurement, you can configure the instrument to subtract a reference value from the measured value and display the difference.

To activate this function, take a measurement, and then press the Δ REL button. This measurement becomes the reference (Rref) and will be stored and subtracted from subsequent measurement values (Rmeas). The Δ REL symbol appears on the LCD while this function is activated.

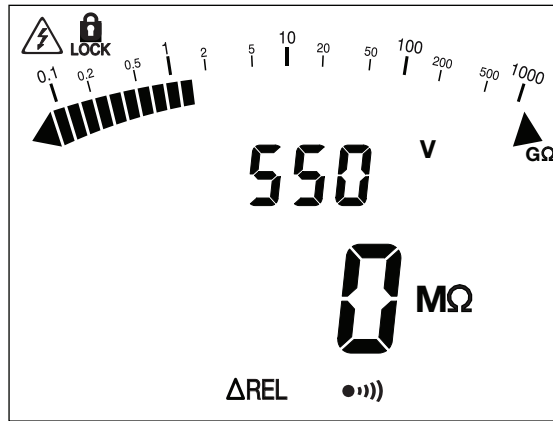

If the measured value is less than the stored value, the display becomes negative.

You can display the difference as a percentage of the reference ($\frac{R_{meas} - R_{ref}}{R_{ref}} \times 100$) by pressing the ► button until the % sign appears:

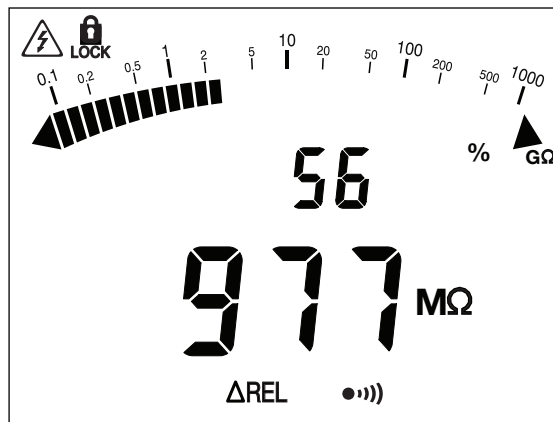

i For insulation measurements, only the digital display is modified by ΔREL. The bar graph continues to display the true measured value.

To deactivate the ΔREL function, press the ΔREL button or turn the rotary switch to another setting.

2.1.5 HOLD Function



Pressing the **HOLD** button freezes the display of the measurement. This can be done in all functions except the MΩ settings, or during a timed measurement (⌚, DAR, PI).

To unfreeze the display, press the **HOLD** button again.

2.1.6 Backlighting



Pressing the ☀ button turns ON backlighting for the LCD.

To switch it OFF, press the ☀ button again. Otherwise, backlighting goes OFF automatically at the end of one minute.

2.1.7 Standby Mode

After 5 minutes of operation with no user activity, the instrument automatically switches to standby mode. To restore normal operation, simply press any button. The instrument returns to the state it was in prior to entering standby mode, with no loss information (value of the last measurement, compensation of the leads, Δ Rel, timed mode, alarm, etc.).

Automatic switching to standby mode is disabled during:

- insulation measurements in lock mode and in timed mode (PI , or **DAR**).
- continuity measurements, for as long as measurements are made.

Automatic switching to standby is disabled via the SET-UP button (see § 2.1.1).

2.2 Taking Measurements

2.2.1 Voltage Measurement

 To ensure proper and accurate operation of the instrument, we recommend measuring a known voltage (such as an electrical outlet) before measuring unknown voltages.

1. Set the switch to **V** or to one of the **M Ω** positions.

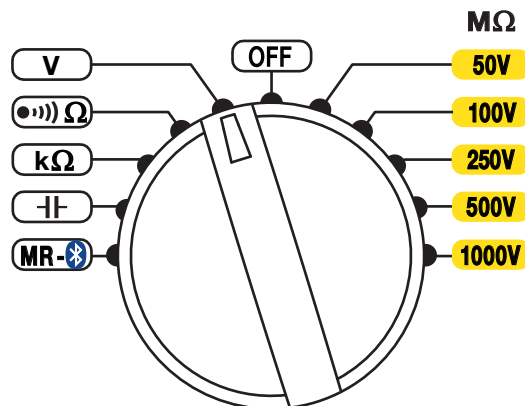

2. Using the leads, connect the system to be tested to the instrument's terminals.

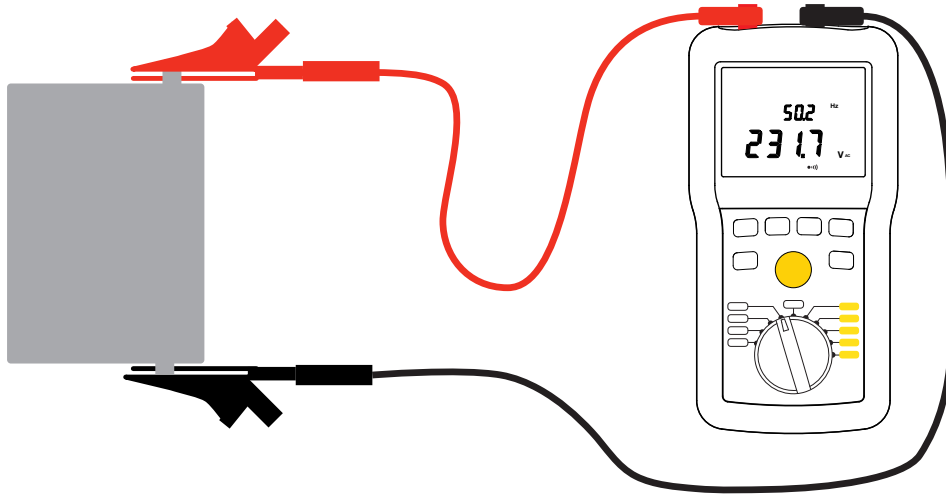

The instrument displays the voltage on the terminals. It detects whether the voltage is AC or DC; and (for Models 6526 and 6532) if it is AC, displays its frequency.

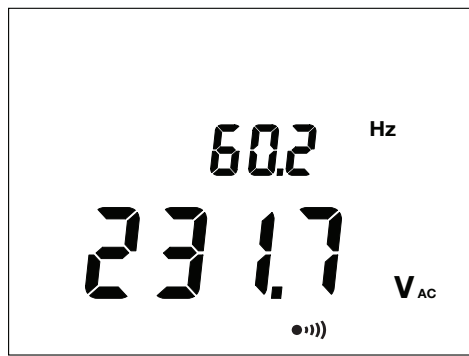

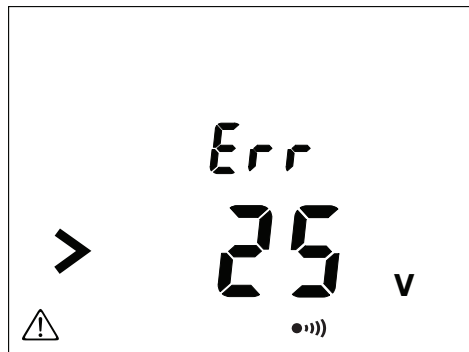

In the **MΩ** settings, the  symbol indicates that the voltage is too high (>25V) and that insulation measurements are prohibited.



If the voltage is >15V, continuity, resistance, and capacitance measurements are prohibited.

2.2.2 Insulation Measurement

 Insulation measurement results can be affected by the impedances of additional circuits connected in parallel or by transient currents.

Do not start any measurement while the symbol  is displayed.

1. Set the rotary switch to one of the **MΩ** positions. The test voltage depends on the voltage of the installation to be tested.

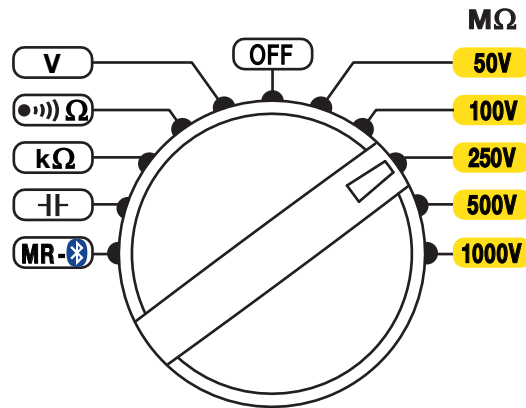

2. Use the leads to connect the system to be tested to the instrument's terminals. The system under test must be powered down and discharged. When testing insulation, the typical connection is negative (black) lead to conductor and positive (red) lead to ground or the outer insulation of the device under test.

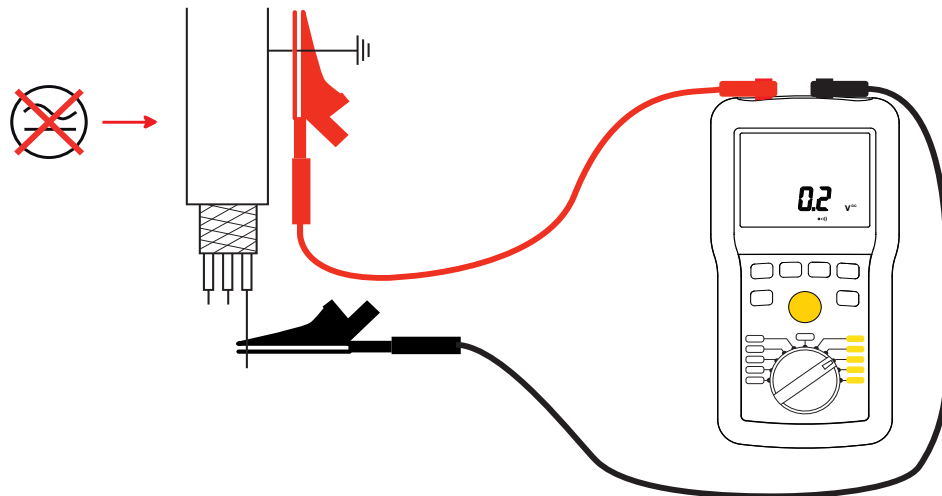

3. (Optional) Press the  button to display the current or the elapsed time. (You can also do this during the measurement.)
4. Press the **TEST** button and hold it down until the displayed measurement is stable. Note that if the instrument detects a voltage greater than 25V in the system under test, pressing the **TEST** button has no effect because the test will be prohibited.
5. The resistance measurement is displayed on the LCD's main display area and on the bar graph. The secondary display area indicates the test voltage generated by the instrument.

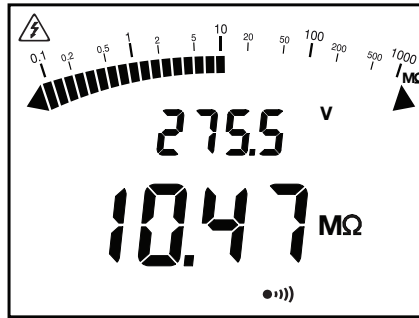
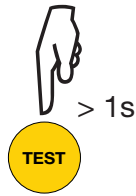

The ⚡ symbol indicates that the instrument is generating a hazardous voltage (>70V).

- At the end of the measurement, release the **TEST** button. The instrument stops generating the test voltage and discharges the device being tested. The ⚡ symbol is displayed until the voltage on the system under test has fallen below 70V.



Do not disconnect the leads and do not start any measurement while the symbol ⚡ is displayed.

When you release the **TEST** button, the measurement results remain displayed until the next measurement, or the **HOLD** button is pressed, or the instrument is turned OFF.

2.2.2.1 TEST Button Operation



Pressing the **TEST** button starts an insulation measurement. In normal mode, the test voltage is generated for as long as the button is pressed. When the button is released, the measurement stops.

In **LOCK** mode, press the test button once to start the measurement, then press it a second time to stop; there is no need to keep the button pressed. However, if you do not stop the measurement, it will stop automatically after 15 minutes.

In timed test mode (⌚, **DAR**, **PI**) press the **TEST** button once to start the measurement. The test will stop automatically at the end of the defined test duration time.

2.2.2.2 Timed Tests

The **TIMER** (⌚) button activates timed test mode. This button is active only for insulation measurements.

1 st press	 LOCK	This locks the TEST button. After you start the measurement, it continues to run without requiring you to keep the TEST button pressed. The test will run until you stop it, or when 15 minutes have passed.
2 nd press	 2:00	This activates timed test mode. You can set a test duration between 1 and 39:59 minutes. Use the ► and ▲ buttons to modify the value displayed. When the time duration is displayed, press the ► button to enter edit mode. When the first digit blinks, you can change it using the ▲ button. Press ► to go to the next digit and ▲ to change it. Then press ► to validate.
3 rd press	PI T2 10:00	This enables the PI function. This is used to calculate the polarization index (the ratio of the measurement at 10 minutes to the measurement at 1 minute).
4 th press	DAR T2 1:00	This enables the DAR function. This is used to calculate the dielectric absorption ratio (the ratio of the measurement at 1 minute to the measurement at 30 seconds).
5 th press		Exits timed test mode.

When \odot , **DAR**, or **PI** is activated, pressing the **TEST** button starts the test. The LCD displays the measurement, along with a “countdown” timer showing the time remaining in the test. The test automatically stops when the duration end time is reached and the result is displayed.



Successive presses on the \blacktriangle button display intermediate values. These include

For \odot :

- Programmed time, voltage, and current at the end of the measurement

For **PI** and **DAR**:

- T1 time and the voltage, current, and insulation resistance at that time
- T2 time and the voltage, current, and insulation resistance at that time.

Use the following table as a guide for interpreting the results of a **DAR** or **PI** test:

DAR	PI	Condition of insulation
$\text{DAR} < 1.25$	$\text{PI} < 2$	Poor or even dangerous
$1.25 \leq \text{DAR} < 1.6$	$2 \leq \text{PI} < 4$	Good
$1.6 \leq \text{DAR}$	$4 \leq \text{PI}$	Excellent



Press the **TEST** button to return to voltage measurement.

2.2.2.3 Remote Control Probe (Optional)

The optional remote control probe is used to trigger the measurement using the **TEST** button on the probe. To use this accessory, refer to its separate operating instructions.

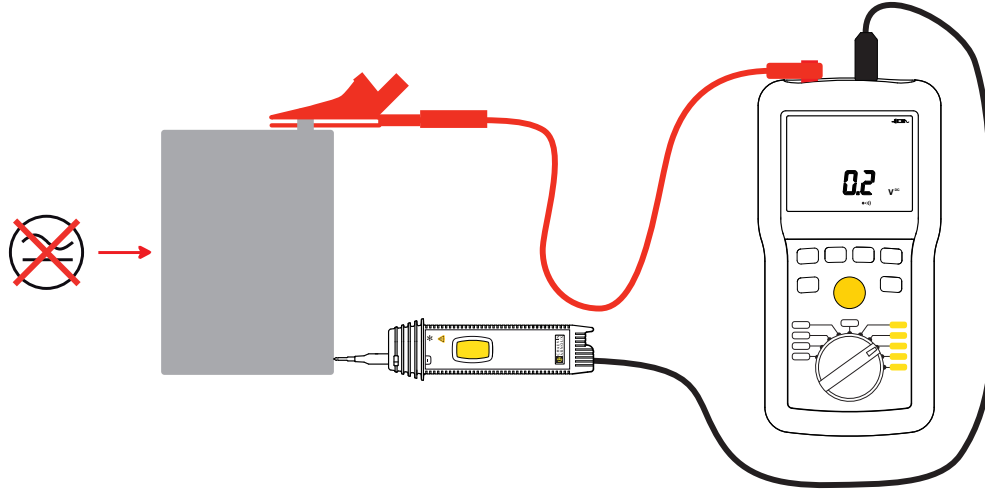

When the probe is connected, the  symbol is displayed on the instrument's LCD.

2.2.3 Continuity Measurement

Continuity measurement measures a low resistance (<10 or 100 Ω depending on the current) at a high current (200 or 20mA).



A current of 20mA reduces the power consumption of the instrument, increasing its battery life. However, the standard IEC 61557 requires 200mA current for continuity testing.

If an external voltage >15V is detected in the system under test during the continuity measurement, the instrument is protected without a fuse. The continuity measurement is stopped and the instrument reports an error until the voltage disappears.

2.2.3.1 Lead Compensation

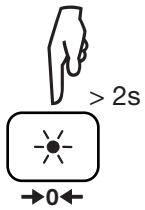

Before checking continuity, you should compensate for the resistance of the measurement leads. This ensures that the resistance measurement excludes the resistance in the leads. To do this, set the rotary switch to Ω . Then short-circuit the measurement leads and press the $\rightarrow 0 \leftarrow$ button for >2 seconds.

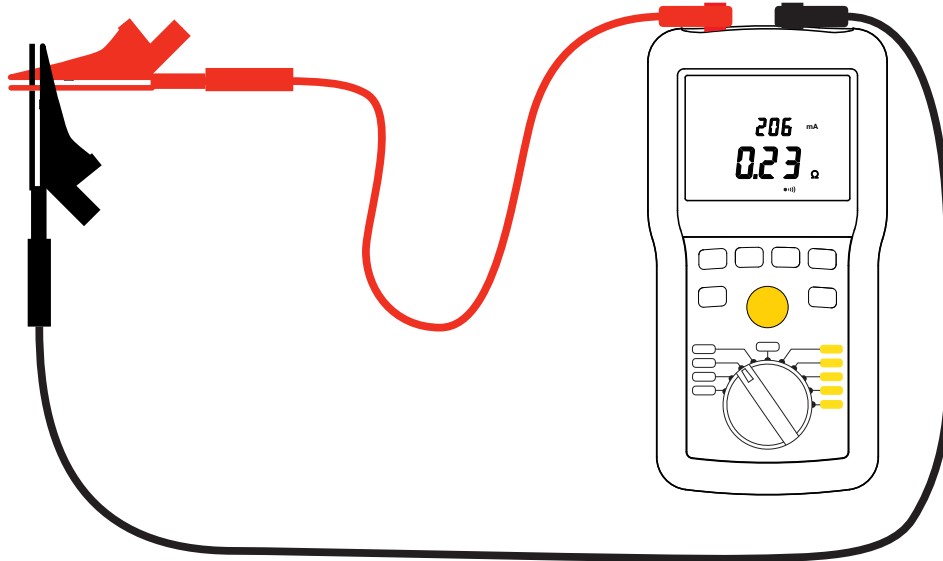

The display changes to zero and the $\rightarrow 0 \leftarrow$ symbol is displayed. The resistance of the leads will be systematically subtracted from all continuity measurements. If the resistance of the leads is $>10\Omega$, there is no compensation. The compensation remains in memory until the instrument is turned OFF.

If the leads are changed with no change of compensation, the display may become negative. The instrument reports that the compensation must be redone by displaying a blinking $\rightarrow 0 \leftarrow$ symbol.

To remove the compensation of the leads, leave the leads open and press the $\rightarrow 0 \leftarrow$ button for >2 seconds. The LCD displays the resistance of the leads and the $\rightarrow 0 \leftarrow$ symbol goes off.

To obtain a continuity value per standard IEC 61557:

1. Take a measurement at 200mA and note its value R1.
2. Reverse the leads and note the value R2.

3. Calculate the mean: $R = \frac{R_1 + R_2}{2}$

2.2.4 Resistance Measurement

Resistance measurements up to 1000kΩ are made with a low current.

1. Set the rotary switch to **kΩ**.

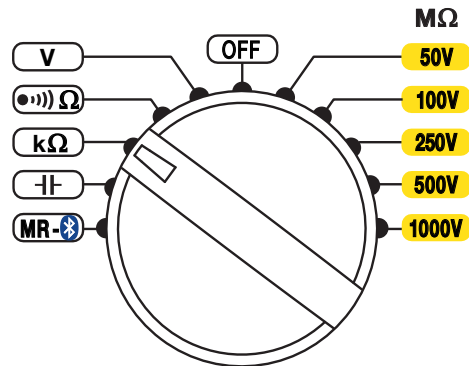

2. Connect the system to be tested to the instrument. The device to be tested must be powered down and discharged.
3. The instrument displays the results.



2.2.5 Capacitance Measurement (Models 6526 and 6532)

1. Set the rotary switch to **⊃F**.

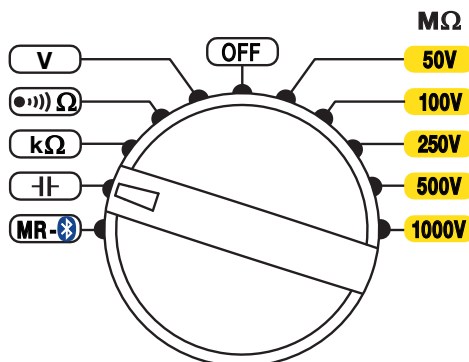

2. Connect the system to be tested to the instrument. The device to be tested must be powered down and discharged.
3. The instrument displays the capacitance and (Model 6532) the corresponding line length, computed from the configured capacitance per unit length: Length = capacitance / capacitance per unit length.



2.3 Recording Data

2.3.1 Recording a Measurement

A measurement can be stored in the instrument's memory if the measurement is:

- "Frozen" on the LCD via the **HOLD** button (§ 2.1.5)
- The result of a timed test (§ 2.2.2.2)

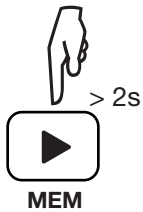

To save the measurement, press the **MEM** button for >2 seconds. The measurement is stored in the first available record in the instrument's memory.

The saved recording includes all information associated with the measurement, including voltage, current, duration of tests, T1 and T2 (for **PI** and **DAR**), and other data. The recording also includes a bar graph indicating how much available memory remains in the instrument.

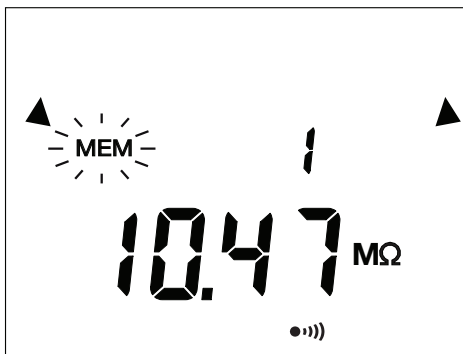

2.3.2 Viewing Stored Recordings

1. Set the rotary switch to **MR**.

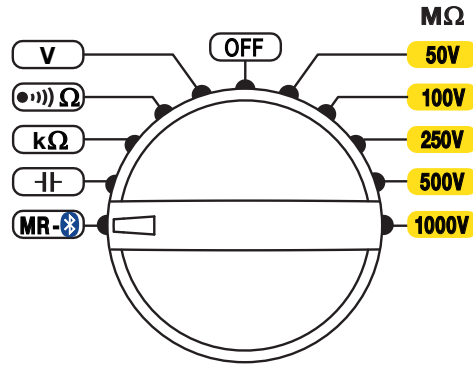

2. The instrument displays the last recording stored in the instrument. The secondary (top) display indicates the memory location; while the main display indicates the measured value.

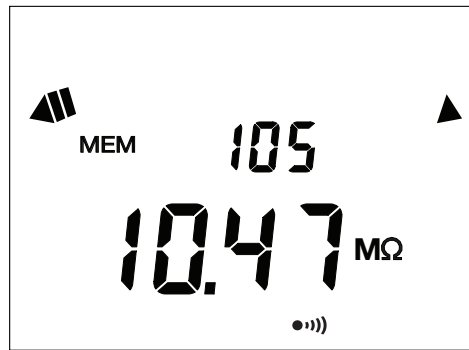

To see the other measurements, press the ▲ button. The record number is decremented and the corresponding measurement is displayed.

3. To scroll rapidly through the recorded measurements, keep the ▲ button pressed.
4. To select a specific recording, use the ► button to change the recording number.
5. Once you select the recording number, you can see all information associated with the measurement. Press the **MEM** button for >2 seconds, then use the ▲ button to scroll the information.
6. When finished viewing recordings, press **MEM** for >2 seconds.

2.3.3 Deleting Recordings

2.3.3.1 Deleting a Single Recording

1. Set the rotary switch to **MR**.
2. Use the **▲** and **▶** buttons to select the number of the recording to be deleted.
3. Press the **CLR** button for >2 seconds. The record number blinks and the LCD displays the letters **CLR**.
4. Press the **MEM** button for >2 seconds to confirm the deletion. To cancel, press the **CLR** button for >2 seconds.

2.3.3.2 Deleting All Recordings

1. Set the rotary switch to **MR**.
2. Press the **CLR** button for >2 seconds.
3. Press the **▲** button; the record number is replaced by **ALL**.
4. To cancel, press the **CLR** button for >2 seconds. Otherwise, press the **MEM** button for >2 seconds to confirm the deletion.
5. The instrument displays a message indicating the memory is empty.



3. TECHNICAL SPECIFICATIONS

3.1 General Reference Conditions

Quantity of Influence	Reference Values
Temperature	73.4° ± 5.4°F (23° ± 3°C)
Relative humidity	45 to 55% RH
Frequency	DC and 45 to 65Hz
Supply voltage	8V ± 0.2V battery life indication 58% ± 8%
Electric field	0V/m
Magnetic field	< 40A/m

- **The intrinsic uncertainty** is the error specified for the reference conditions.
- **The operating uncertainty** includes the intrinsic uncertainty plus variations of the quantities of influence (position, supply voltage, temperature, etc.) as defined in standard IEC 61557.

 In this section, uncertainties are typically expressed as % of the reading (R) plus number of display counts (ct).

3.2 Electrical Specifications

3.2.1 Voltage Measurement

Specific reference conditions: Peak factor = 1.414 in AC, sinusoidal signal.

Measurement Range	0.3 to 399.9V	400 to 700V
Resolution	0.1V (AC and DC)	1V (AC and DC)
Accuracy	± (3% R + 2 ct)	
Input impedance	400kΩ	
Frequency ranges	DC and 15.3 to 800Hz	

3.2.2 Frequency Measurement

Measurement Range	15.3 to 399.9Hz	400 to 800Hz
Resolution	0.1Hz	1Hz
Accuracy	± (1% R + 2 ct)	± (1.5% R + 1 ct)

3.2.3 Insulation Measurement

Specific reference condition: Capacitance in parallel on resistance = null

Measurement ranges per model

Test Voltage	Model 6526	Model 6532	Model 6534
10V			2kΩ to 1GΩ
25V			5kΩ to 2GΩ
50V	10kΩ to 10GΩ	10kΩ to 10GΩ	
100V	20kΩ to 20GΩ	20kΩ to 20GΩ	20kΩ to 10GΩ
250V	50kΩ to 50GΩ		50kΩ to 25GΩ
500V	100kΩ to 100GΩ		100kΩ to 50GΩ
1000V	200kΩ to 200GΩ		

Accuracy

Model 6526

Test Voltage (V_T)	50V - 100V - 250V - 500V - 1000V					
Measurement range	10 to 999kΩ and 1.000 to 3.999 MΩ	4.00 to 39.99MΩ	40.0 to 399.9MΩ	400 to 3999MΩ	4.00 to 39.99GΩ	40.0 to 200.0GΩ
Resolution	1kΩ	10kΩ	100kΩ	1MΩ	10MΩ	100MΩ
Accuracy	$V_T = 50V: \pm (3\% R + 2 \text{ ct} + 2\%/G\Omega)$ $V_T = 100V: \pm (3\% R + 2 \text{ ct} + 1\%/G\Omega)$ $V_T = 250V: \pm (3\% R + 2 \text{ ct} + 0.4\%/G\Omega)$ $V_T = 500V: \pm (3\% R + 2 \text{ ct} + 0.2\%/G\Omega)$ $V_T = 1000V: \pm (3\% R + 2 \text{ ct} + 0.1\%/G\Omega)$					

Models 6532 and 6534

Test Voltage (V_T)	10V - 25V - 50V - 100V - 250V - 500V					
Measurement range	2 to 999kΩ and 1.000 to 3.999 MΩ	4.00 to 39.99MΩ	40.0 to 399.9MΩ	400 to 3999MΩ	4.00 to 39.99GΩ	40.0 to 50.0GΩ
Resolution	1kΩ	10kΩ	100kΩ	1MΩ	10MΩ	100MΩ
Accuracy	$V_T = 10V: \leq 999k\Omega: \pm (4\% R + 20 \text{ ct}); \geq 1.000M\Omega \pm (3\% R + 2 \text{ ct} + 1\%/100M\Omega)$ $V_T = 25V: \pm (3\% R + 2 \text{ ct} + 0.4\%/100M\Omega)$ $V_T = 50V: \pm (3\% R + 2 \text{ ct} + 2\%/G\Omega)$ $V_T = 100V: \pm (3\% R + 2 \text{ ct} + 1\%/G\Omega)$ $V_T = 250V: \pm (3\% R + 2 \text{ ct} + 0.4\%/G\Omega)$ $V_T = 500V: \pm (3\% R + 2 \text{ ct} + 0.2\%/G\Omega)$					

For all test voltages, when the insulation resistance is $\leq 2G\Omega$ the intrinsic uncertainty is $\pm (3\% R + 2 \text{ ct})$.

Bar Graph

Measurement Range	0.1MΩ to 200GΩ *
Resolution	9 segments per decade
Accuracy	± (5% R + 1 segment)

*When the measurement range is exceeded, the whole bar graph is displayed.

Test Voltage

Measurement Range	0.0 to 399.9V	400 to 1250V
Resolution	0.1V	1V
Accuracy	± (3% R + 3 ct)	

Typical discharge time after test

To go from V_T to 25V, the discharge time is $< 2s/\mu F$.

Test Current

Maximum test current: 2mA

Measurement Range	0.01 to 39.99μA	40.0 to 399.9μA	0.400 to 2.000mA
Resolution	10nA	100nA	1μA
Accuracy	± (10% R + 3 ct)		

Typical test voltage vs load curve

The voltage as a function of the measured resistance is illustrated below:

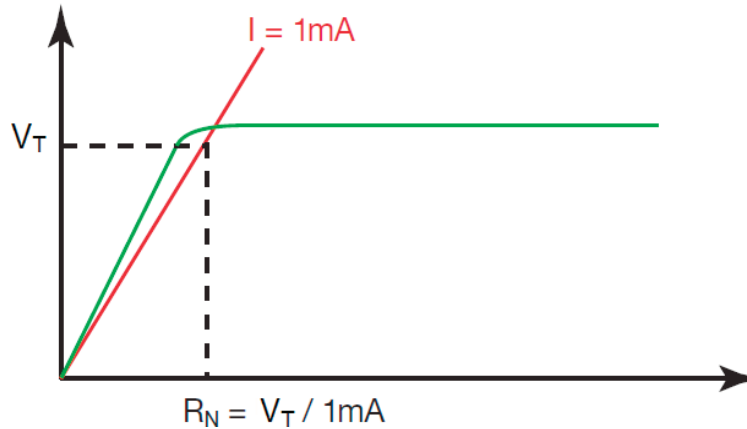

The range of operation per IEC 61557 is from 100kΩ to 2GΩ (see § 3.4).

3.2.4 Continuity Measurement

Specific reference condition: Inductance in series with the resistance = zero.

Measurement Range (without compensation of the leads)	0.00 * to 10.00Ω	0.0 * to 100.0Ω
Resolution	10mΩ	100mΩ
Accuracy	± (2% + 2 ct)	
Test current	200mA	20mA
Open voltage	≥ 6V	

*In the case of incorrect compensation of the leads, the instrument allows display of negative values, down to -0.05Ω at 200 mA and -0.5Ω at 20mA.

Test Current

200mA range: 200mA (0mA + 20mA)

20mA range: 20mA ± 5mA

Measurement Range	0 to 250mA
Resolution	1mA
Accuracy	± (2% + 2 ct)

Compensation of the leads: 0 to 9.99Ω.

3.2.5 Resistance Measurement

Measurement Range	0 to 3999Ω	4.00 to 39.99kΩ	40.0 to 399.9kΩ	400 to 1000kΩ
Resolution	1Ω	10Ω	100Ω	1kΩ
Accuracy	± (3% + 2 ct)			
Open voltage	approximately 4.5V			

3.2.6 Capacitance Measurement (Models 6526 and 6532)

Capacitance

Measurement Range	0.1 to 399.9nF	400 to 3999nF	4.00 to 10.0μF
Resolution	0.1nF	1nF	10nF
Accuracy	± (3% + 2 ct)		

Line length (Model 6532)

Capacitance per unit length: 40 to 60 nF/km (50 nF/km is the default)

Measurement Range	0 to 3.999km	4.00 to 39.99km	40.0 to 100.0km
Resolution	1m	10m	100m
Accuracy	± (3% + 2 ct)		

3.2.7 Timer

Measurement Range	0:00 to 39:59
Resolution	1s
Accuracy	± 1% of duration

3.2.8 Storage Memory

Maximum number of recordings stored in memory: 1300

3.2.9 Bluetooth

Bluetooth 2.1; Class II; Range 10m (approximately 33ft)

3.3 Operating Environment

3.3.1 Voltage Measurement

Influencing Parameter	Range of Influence	Quantity Influenced	Influence	
			Typical	Maximum
Temperature	-4 to 131°F (20 to + 55°C)	V, F		0.3% R/18°F + 1 ct (0.3% R/10°C + 1 ct)
Relative humidity	20 to 80% RH	V, F		1% R + 2 ct
Frequency	15.3 to 800Hz	V	1%	2% R + 1 ct
Supply voltage	6.6 to 9.6V	V, F		0.1% R + 2 ct
Common mode rejection in AC 50/60 Hz	0 to 600V _{AC}	V	50dB	40dB

3.3.2 Insulation Measurement

Influencing Parameter	Range of Influence	Quantity Influenced	Influence	
			Typical	Maximum
Temperature	-4 to 131°F (-20 to + 55°C)	MΩ R ≤ 3GΩ 3GΩ < R < 10GΩ 10GΩ ≤ R	1% R/10°C + 1pt	2% R/10°C + 2 ct 3% R/10°C + 2 ct 4% R/10°C + 2 ct
		V _T : 50 to 500V V _T : 1000V		0.5% R/10°C + 1 ct 1% R/10°C + 1 ct
		Measurement current	1% R/10°C + 1 ct	2% R/10°C + 2 ct
Relative humidity	20 to 80% RH	MΩ	2% R + 1 ct	3% R + 2 ct
		V _T : 50 to 1000V		1% R + 2 ct
		Measurement current		1% R + 2 ct
Supply voltage	6.6 to 9.6V	MΩ		0.1% R + 2 ct
50/60Hz AC voltage superposed on the test voltage (V _T)		10V range R ≤ 0.1GΩ : 10V from 0.1 to 0.3GΩ : 0.2V		5% R + 2 ct
		25V range R ≤ 0.1GΩ : 10V from 0.1 to 0.5GΩ : 0.2V		
		50V range R ≤ 0.1GΩ : 4V from 0.1 to 1GΩ : 0.2V		
		100V and 250V ranges from 100kΩ to 10MΩ : 20V from 10MΩ to 1GΩ : 0.3V		
		500V and 1000V ranges from 500kΩ to 50MΩ : 20V from 50MΩ to 3 GΩ : 0.3V		
Capacitance in parallel on resistance to be measured	0 to 5μF at 1mA	MΩ		1% R + 1 ct
	0 to 2μF	10V and 25V ranges from 10kΩ to 1GΩ	2% R + 1 ct	3% R + 2 ct
		50V, 100V and 250V ranges from 10kΩ to 3GΩ	6% R + 2 ct	10% R + 2 ct
		500V and 1000V ranges from 100kΩ to 10GΩ	6% R + 2 ct	10% R + 2 ct
	0 to 1μF	50V range, ≤5GΩ 250V range, ≤15GΩ 1000V range, ≤100GΩ	6% R + 2 ct	10% R + 2 ct
Common mode rejection in AC 50/60 Hz	0 to 600Vac	V	50dB	40dB

3.3.3 Resistance and Continuity Measurement

Influencing Parameter	Range of Influence	Quantity Influenced	Influence	
			Typical	Maximum
Temperature	-4 to 131°F (-20 to + 55°C)	at 200mA		2% R/10°C + 2 ct
		at 20mA		2% R/10°C + 2 ct
		R		1% R/10°C + 2 ct
Relative humidity	20 to 80% RH	at 200mA		4% R + 2 ct
		at 20mA		4% R + 2 ct
		R		3% R + 2 ct
Supply voltage	6.6 to 9.6V	at 200mA at 20mA R		0.1% R + 2 ct
50/60Hz AC voltage superposed on the test voltage (V_T)	0.5VAc	at 200mA		5% R + 10 ct
	For $R \geq 10\Omega$: 0.4VAc	at 20mA		
	Accepts no perturbations	R		
Common mode rejection in AC 50/60 Hz	0 to 600VAc	at 200mA at 20mA R	50dB	40dB

3.3.4 Capacitance Measurement (Models 6526 and 6532)

Influencing Parameter	Range of Influence	Quantity Influenced	Influence	
			Typical	Maximum
Temperature	-4 to 131°F (-20 to + 55°C)	μ F	0.5% R/10°C + 1 ct	1% R/10°C + 2 ct
Relative humidity	20 to 80% RH	μ F		1% R + 2 ct
Supply voltage	6.6 to 9.6V	μ F		0.1% R + 2 ct
50/60Hz AC voltage superposed on the test voltage (V_T)	0.5VAc	μ F		5% R + 2 ct
Common mode rejection in AC 50/60 Hz	0 to 600VAc	μ F	50dB	40dB

3.4 Intrinsic Uncertainty and Operating Uncertainty

These megohmmeters comply with standard IEC 61557, which requires that the operating uncertainty (called B) must be less than 30%.

In insulation and continuity measurements:

$$B = \pm(|A| + 1.15 \sqrt{E_1^2 + E_2^2 + E_3^2})$$

where:

A = intrinsic uncertainty

E_1 = influence of the reference position $\pm 90^\circ$

E_2 = influence of the supply voltage within the limits indicated by the manufacturer

E_3 = influence of the temperature between 32 and 95°F (0 and 35°C)

3.5 Power Supply

The instrument is powered by six 1.5V alkaline AA (LR6) batteries.

The voltage range ensuring correct operation is from 6.6V to 9.6V.

Typical life between charges:

- Insulation:
 - 1500 5-second insulation measurements at 1000V for R = 1 MΩ, at the rate of one measurement per minute
 - 2500 5-second measurements at 500V for R = 500kΩ, at the rate of one measurement per minute
 - 6000 5-second measurements at 100V for R = 100kΩ, at the rate of one measurement per minute
- Continuity: 3000 5-second continuity measurements, at the rate of one measurement per minute

3.6 Environmental Conditions

Indoor use

Range of operation: -4 to 131°F (-20 to +55°C) and 20 to 80% RH

Range of storage (without batteries): -22 to 176°F (-30 to +80°C) and 10 to 90% RH without condensation

Altitude: <2000m (6562ft)

Degree of pollution: 2

3.7 Mechanical Specifications

Dimensions (L x W x H): 211 x 108 x 60mm (8.31 x 4.25 x 2.36")

Weight: approximately 850g (1.87lb)

Ingress protection:

- IP 54 per IEC 60529, not in operation
- IK 04 per IEC 50102

Drop test: per IEC 610

3.8 Safety Standards

Safety according to: EN 61010

Insulation Class: 2

Pollution Degree: 2

Overvoltage Category: 600V CAT IV

Immunity according to: EN 61326

Emission according to: EN 61326

Specifications are subject to change without notice.

4. DATAVIEW SOFTWARE

AEMC's DataView software enables a computer to connect to and interact with a variety of AEMC instruments, including the Models 6526, 6532, and 6534. DataView includes a core set of features used by all instruments. These features are designed for viewing recorded data; and for opening, creating, and saving DataView reports. DataView also includes applications called Control Panels for interacting with the instrument. A Control Panel lets you connect to the instrument, view real-time measurements, download data, and configure the instrument's settings from the computer. Each AEMC product family has its own dedicated Control Panel; you select the one(s) you need during DataView installation

4.1 Installing DataView

When you purchase the instrument, the product package includes a USB drive containing DataView program files. To begin installation:

1. Insert the DataView drive into an available USB port on your computer.
2. If Autorun is enabled, an AutoPlay window appears on your screen. Click "Open folder to view files" to display the DataView folder. If Autorun is not enabled or allowed, use Windows Explorer to locate and open the USB drive labelled "DataView."
3. When the DataView folder is open, find the file Setup.exe in the root directory and double-click it to run the installation program.
4. The Setup screen appears. This enables you to select the language version of the setup program. You can also select additional install options (each option is explained in the Description field). Make your selections and click Install.
5. Click OK to confirm setup. The InstallShield Wizard screen appears. This program leads you through the DataView install process. As you complete these screens, be sure to check Megohmmeter when prompted to select features to install.
6. When the InstallShield Wizard finishes installing DataView, the Setup screen appears. Click Exit to close. The DataView folder appears on your computer desktop.
7. Open the DataView folder on your desktop. This displays a list of icons for the Control Panel(s) installed with DataView.
8. Open the DataView Megohmmeter Control Panel by clicking the  icon.

For more information, consult the DataView Megohmmeter Control Panel Help.

4.2 Megohmmeter Control Panel

In general, DataView features are used for creating, viewing, editing, and storing DataView reports; while the Control Panel is used for connecting to, configuring, viewing real-time measurements, running real-time tests, and downloading data from the instrument. For users who interact with a single type of AEMC instrument, we recommend primarily using the Control Panel.

For further information about DataView and its capabilities, or for information about using the Megohmmeter Control Panel, consult the Help system that comes with the product.

4.3 Connecting to the Computer

Before you can use the Megohmmeter Control Panel to communicate with your instrument, you must establish a Bluetooth wireless connection between the instrument and the computer running DataView.



To begin, ensure that you have installed DataView, and selected the Megohmmeter Control Panel during the installation process (see § 4.1). Also ensure that the required communication and connection drivers are installed on your computer. These drivers are installed as part of the DataView installation process. Bluetooth must be enabled on the instrument (see § 4.3.1) and your computer. Some computers have Bluetooth connectivity built in, while others require a Bluetooth-USB adapter. When this adapter is plugged into a USB port and configured with the appropriate driver, the computer can communicate via Bluetooth.

To connect the instrument to the computer, you must pair it via Bluetooth (§ 4.3.2) and then use the Control Panel to establish the connection to DataView (§ 4.3.3).

4.3.1 Enabling Bluetooth on the Instrument

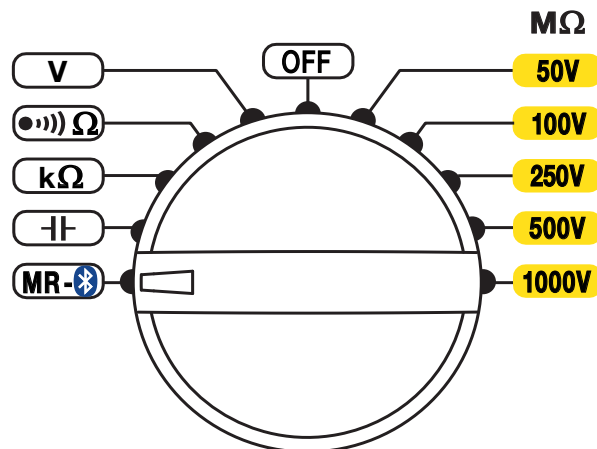
1. Set the rotary switch to **MR** .



2. Press the  button for >2 seconds. The  icon appears on the LCD, indicating Bluetooth is enabled on the instrument.

4.3.2 Pairing the Instrument to the Computer

1. Open the Bluetooth Devices dialog on your computer to pair the instrument with your computer. Different operating systems have different steps for opening this dialog, so consult your computer's documentation for instructions.
2. Once the dialog is displayed, click Add a Device. A dialog box appears listing the locally available Bluetooth devices. There may be several devices of varying types listed, depending on the location of your computer.
3. Find the instrument's Bluetooth name, and click it.
4. You are prompted to enter a pairing code; enter 1111.
5. After you enter the code, click Next. A screen appears informing you that the instrument has been successfully connected with the computer. Click Close to exit the screen.

 To view real-time data in the DataView Control Panel, the instrument dial must be turned to the appropriate measurement range.

4.3.3 Connecting the Instrument with the Control Panel

When the computer is Bluetooth-ready, you can connect to the instrument as follows:

1. Open the Megohmmeter Control Panel. In the menu bar at the top of the screen, select Help. In the drop-down menu that appears, click the option Help Topics. This opens the Megohmmeter Control Panel Help system.
2. Use the Contents window in the Help system to locate and open the topic "Connecting to an Instrument." This topic provides instructions explaining how to connect your instrument to the computer.
3. After the instrument is successfully connected, consult the Control Panel Help system for instructions about viewing real-time data, downloading and viewing recorded sessions, creating DataView reports from the downloaded data, and configuring the instrument through the Control Panel.

5. MAINTENANCE AND TROUBLESHOOTING

 Except for the batteries, the instrument contains no parts that can be replaced by personnel who have not been specially trained and accredited. Any unauthorized repair or replacement of a part by an “equivalent” may impair safety.

5.1 Maintenance

5.1.1 Cleaning

Disconnect the unit completely and turn the rotary switch to OFF.

Use a soft cloth, dampened with soapy water. Rinse with a damp cloth and dry rapidly with a dry cloth or forced air. Do not use alcohol, solvents, or hydrocarbons.

Do not use the instrument again until it is completely dry.

5.1.2 Replacing the Batteries

At start-up, the instrument displays the remaining battery life:

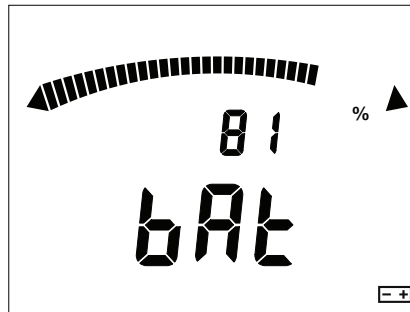

If the battery voltage is too low to ensure correct operation of the instrument, a “low battery” message appears on the LCD and the  symbol blinks:



This indicates the batteries must be replaced. All batteries must be replaced at the same time. To do this:

1. Disconnect any attached leads or accessories from the instrument and turn the rotary switch to OFF.
2. Use a tool or a coin to turn the quarter-turn screw of the battery compartment cover.
3. Remove the battery compartment cover.
4. Remove the batteries from the compartment.

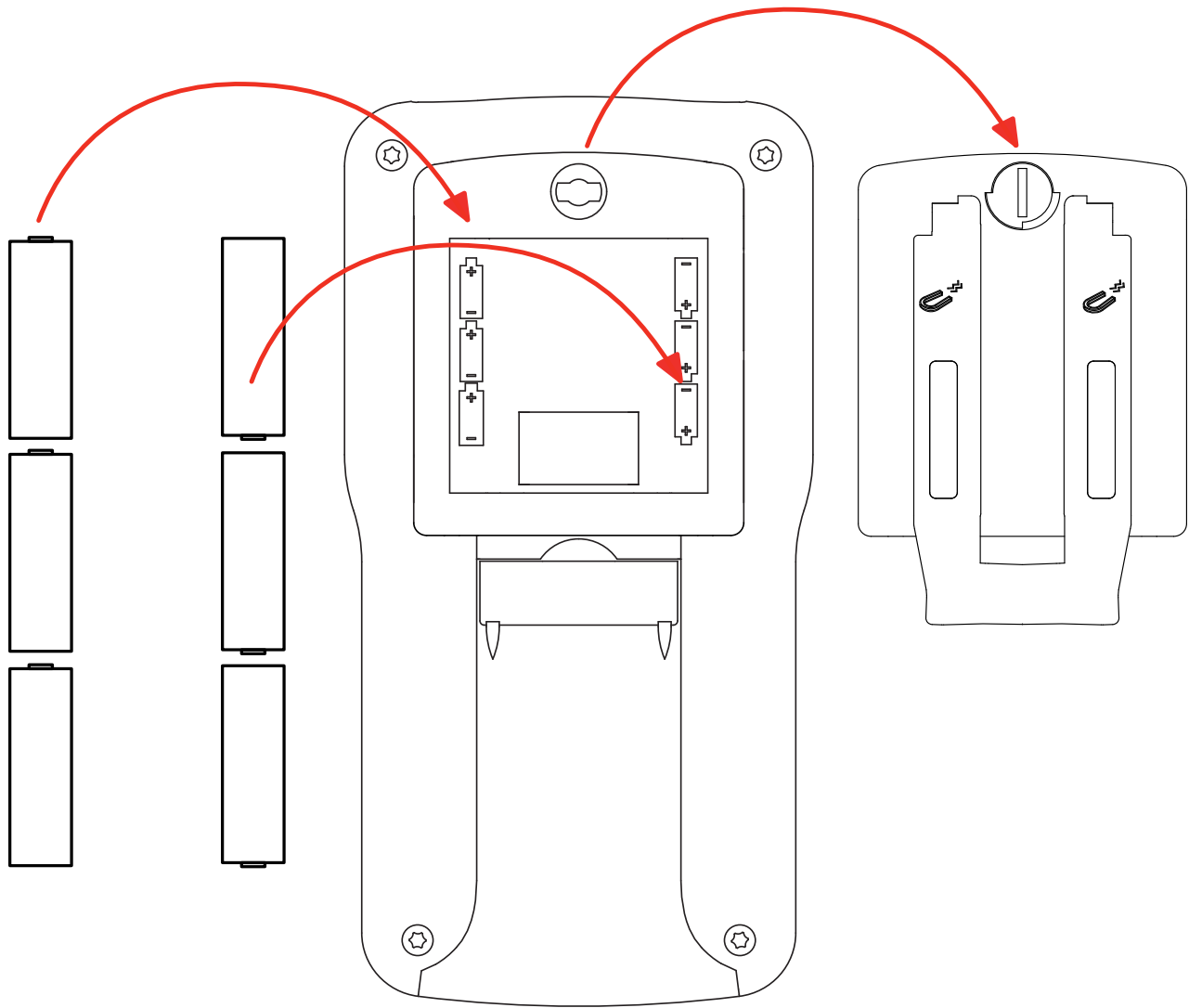

Do not treat spent batteries as ordinary household waste. Take them to the appropriate collection facility for recycling.

5. Place the new batteries in the compartment, ensuring that each battery's polarity is correct.
6. Put the battery compartment cover in place and screw the quarter-turn screw back in.

5.2 Troubleshooting

5.2.1 Errors

During instrument operation, errors may be displayed on the LCD. The causes of any errors must be corrected before the instrument can resume normal operation.

5.2.1.1 Voltage present before an insulation measurement

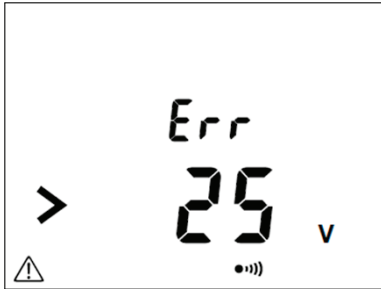

Before taking an insulation measurement, the instrument measures voltage on the system under test. If it detects voltage in excess of 25V and you attempt to take a measurement, the instrument displays the message shown to the left, and no measurement is taken.

You must eliminate the voltage to resume taking the measurement.

5.2.1.2 Range exceeded during an insulation measurement



If during an insulation measurement the value to be measured exceeds the measurement range (which depends on the instrument and the test voltage), the instrument reports this condition. For example, the screen to the left is displayed when the range is exceeded on the Model 6532 while measuring in the 100V range.



With the Models 6526 and 6532, if this condition occurs during a DAR or PI measurement, the instrument interrupts the measurement and displays the screen shown to the left.

5.2.1.3 Voltage present during a continuity, resistance, or capacitance measurement (Models 6526 and 6532)

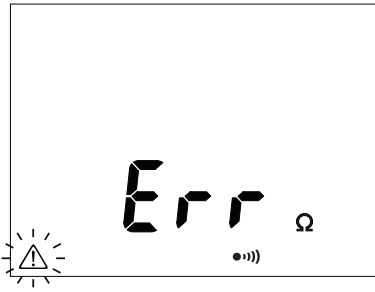

If during a continuity, resistance, or capacitance measurement the instrument detects an external voltage in excess of 15V (AC or DC), it interrupts the measurement and displays the screen shown to the left.

You must eliminate the voltage to resume the measurement.

5.2.1.4 Memory full

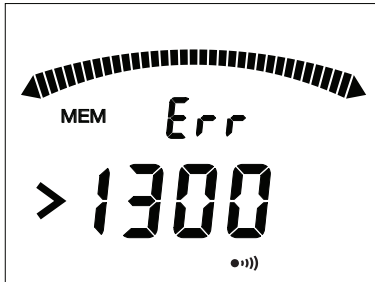

When the memory is full, the instrument displays the screen shown to the left. You must remove one or more recordings before new recordings can be saved (see § 2.3.3).

5.2.2 Resetting the Instrument

You can reset your instrument at any time. To do this:

1. Press the ▲ and  buttons simultaneously.
2. Turn the rotary switch to any setting other than OFF.
3. The instrument reboots.

5.3 Repair and Calibration

To ensure that your instrument meets factory specifications, we recommend that it be scheduled to be sent back to our factory Service Center at one-year intervals for recalibration, or as required by other standards or internal procedures.

For instrument repair and calibration:

You must contact our Service Center for a Customer Service Authorization Number (CSA#). This will ensure that when your instrument arrives, it will be tracked and processed promptly. Please write the CSA# on the outside of the shipping container. If the instrument is returned for calibration, we need to know if you want a standard calibration, or a calibration traceable to N.I.S.T. (Includes calibration certificate plus recorded calibration data.)

Ship To:

(Or contact your authorized distributor.)

Costs for repair, standard calibration, and calibration traceable to N.I.S.T. are available.



NOTE: You must obtain a CSA# before returning any instrument.

5.4 Technical and Sales Assistance

If you are experiencing any technical problems, or require any assistance with the proper operation or application of your instrument, please call, fax, or e-mail our technical support team:

5.5 Limited Warranty

The Model 6526, 6532 and 6534 are warranted to the owner for a period of two years from the date of original purchase against defects in manufacture. This limited warranty is given by AEMC® Instruments, not by the distributor from whom it was purchased. This warranty is void if the unit has been tampered with or abused, or if the defect is related to service not performed by AEMC® Instruments.

Please print the online Warranty Coverage Information for your records.

What AEMC® Instruments will do:

If a malfunction occurs within the warranty period, you may return the instrument to us for repair, provided we have your warranty registration information on file or a proof of purchase. AEMC® Instruments will, at its option, repair or replace the faulty material.

5.6 Warranty Repairs

What you must do to return an Instrument for Warranty Repair:

First, request a Customer Service Authorization Number (CSA#) by phone or by fax from our Service Department (see address below), then return the instrument along with the signed CSA Form. Please write the CSA# on the outside of the shipping container. Return the instrument, postage or shipment pre-paid to:

Ship To:

Caution: To protect yourself against in-transit loss, we recommend you insure your returned material.

NOTE: You must obtain a CSA# before returning any instrument.