

The Fluke logo consists of the word "FLUKE" in a bold, black, sans-serif font, followed by a registered trademark symbol (®). The text is centered within a solid yellow rectangular background.

FLUKE®

1630-2/1630-2 FC

Earth Ground Clamp

Users Manual

February 2017

©2017 Fluke Corporation. All rights reserved.

Specifications are subject to change without notification.

All product names are trademarks of their respective companies.

LIMITED WARRANTY AND LIMITATION OF LIABILITY

Each Fluke product is warranted to be free from defects in material and workmanship under normal use and service. The warranty period is one year and begins on the date of shipment. Parts, product repairs, and services are warranted for 90 days. This warranty extends only to the original buyer or end-user customer of a Fluke authorized reseller, and does not apply to fuses, disposable batteries, or to any product which, in Fluke's opinion, has been misused, altered, neglected, contaminated, or damaged by accident or abnormal conditions of operation or handling. Fluke warrants that software will operate substantially in accordance with its functional specifications for 90 days and that it has been properly recorded on non-defective media. Fluke does not warrant that software will be error free or operate without interruption.

Fluke authorized resellers shall extend this warranty on new and unused products to end-user customers only but have no authority to extend a greater or different warranty on behalf of Fluke. Warranty support is available only if product is purchased through a Fluke authorized sales outlet or Buyer has paid the applicable international price. Fluke reserves the right to invoice Buyer for importation costs of repair/replacement parts when product purchased in one country is submitted for repair in another country.

Fluke's warranty obligation is limited, at Fluke's option, to refund of the purchase price, free of charge repair, or replacement of a defective product which is returned to a Fluke authorized service center within the warranty period.

To obtain warranty service, contact your nearest Fluke authorized service center to obtain return authorization information, then send the product to that service center, with a description of the difficulty, postage and insurance prepaid (FOB Destination). Fluke assumes no risk for damage in transit. Following warranty repair, the product will be returned to Buyer, transportation prepaid (FOB Destination). If Fluke determines that failure was caused by neglect, misuse, contamination, alteration, accident, or abnormal condition of operation or handling, including overvoltage failures caused by use outside the product's specified rating, or normal wear and tear of mechanical components, Fluke will provide an estimate of repair costs and obtain authorization before commencing the work. Following repair, the product will be returned to the Buyer transportation prepaid and the Buyer will be billed for the repair and return transportation charges (FOB Shipping Point).

THIS WARRANTY IS BUYER'S SOLE AND EXCLUSIVE REMEDY AND IS IN LIEU OF ALL OTHER WARRANTIES, EXPRESS OR IMPLIED, INCLUDING BUT NOT LIMITED TO ANY IMPLIED WARRANTY OF MERCHANTABILITY OR FITNESS FOR A PARTICULAR PURPOSE. FLUKE SHALL NOT BE LIABLE FOR ANY SPECIAL, INDIRECT, INCIDENTAL OR CONSEQUENTIAL DAMAGES OR LOSSES, INCLUDING LOSS OF DATA, ARISING FROM ANY CAUSE OR THEORY.

Since some countries or states do not allow limitation of the term of an implied warranty, or exclusion or limitation of incidental or consequential damages, the limitations and exclusions of this warranty may not apply to every buyer. If any provision of this Warranty is held invalid or unenforceable by a court or other decision-maker of competent jurisdiction, such holding will not affect the validity or enforceability of any other provision.

Table of Contents

Title	Page
Introduction	1
How to Contact Fluke	1
Safety Information	2
Before You Start	5
Power On/Off	5
Display Features and Controls	5
Setup	8
Log Interval	8
Alarm Threshold	9
Time/Clock	10
Clamp Settings	10
Backlight Auto-Off	10
Power Auto-Off	11
Firmware Version	11
How to Use the Clamp	12
Ground Resistance Measurements	12
AC Leakage Current Measurement	15
Logging Measurements	16

1630-2/1630-2 FC
Users Manual

Hold	16
Filter	16
Fluke Connect Wireless System	17
Radio Frequency Data	17
Fluke Connect® App	17
Memory	19
View Memory	19
Clear Memory	19
Maintenance	20
Clamp Care	20
Battery Replacement	20
Parts and Accessories	20
Electrical Specifications	22
General Specifications	24
Ground Loop Resistance	25
AC Leakage Current mA	25

Introduction

The Fluke 1630-2/1630-2 FC Earth Ground Clamp (the Product or Clamp) is a handheld, battery-operated clamp that measures the ground resistance without auxiliary ground rods and AC leakage current. The Clamp is used in multi-grounded systems without disconnecting the ground under test.

The Clamp supports these applications:

- Earth resistance and AC leakage current tests of high voltage pylons, buildings, cell phone substations, and RF transmitters
- Inspection of lightning protection systems

The 1630-2 FC supports the Fluke Connect® Wireless System (may not be available in all regions). Fluke Connect is a system that wirelessly connects your Clamp with an app on your smartphone or tablet. The app shows the ground resistance measurements on your smartphone or tablet display. You can save these measurements and images to Fluke Connect® Cloud storage and share with your team. For more information, see *Fluke Connect Wireless System* on page 17.

Your shipment includes:

- 1630-2 or 1630-2 FC Earth Ground Clamp
- AA alkaline batteries, IEC LR6 (x4, installed)
- Resistance test/check loop
- Safety Information and Quick Reference Guide (go to to download the *1630-2/1630-2 FC Users Manual*).
- Carrying Case

How to Contact Fluke

To contact Fluke, call one of the following telephone numbers:

Safety Information

A **Warning** identifies conditions and procedures that are dangerous to the user. A **Caution** identifies conditions and procedures that can cause damage to the Product or the equipment under test.

Warning















To prevent possible electrical shock, fire, or personal injury:

- Carefully read all instructions.
 - Read all safety information before you use the Product.
 - Do not alter the Product and use only as specified, or the protection supplied by the Product can be compromised.
 - Do not use the Product around explosive gas, vapor, or in damp or wet environments.
- Before each use, examine the Product. Look for cracks or missing pieces of the clamp housing or output cable insulation. Also look for loose or weakened components. Carefully examine the insulation around the jaws.
 - Comply with local and national safety codes. Use personal protective equipment (approved rubber gloves, face protection, and flame-resistant clothes) to prevent shock and arc blast injury where hazardous live conductors are exposed.
 - Use Product-approved measurement category (CAT), voltage, and amperage rated accessories (probes, test leads, and adapters) for all measurements.
 - Do not use the Product if it is altered or damaged.
 - Disable the Product if it is damaged.
 - Do not use the Product if it operates incorrectly.

- Do not use the Product above its rated frequency.
- Limit operation to the specified measurement category, voltage, or amperage ratings.
- Do not touch voltages >30 V ac rms, 42 V ac peak, or 60 V dc.
- Hold the Product behind the tactile barrier.
- The battery door must be closed and locked before you operate the Product.
- Replace the batteries when the low battery indicator shows to prevent incorrect measurements.
- Remove the batteries if the Product is not used for an extended period of time, or if stored in temperatures above 50 °C. If the batteries are not removed, battery leakage can damage the Product.
- Do not operate the Product with covers removed or the case open. Hazardous voltage exposure is possible.
- Repair the Product before use if the battery leaks.
- Use only specified replacement parts.
- Have an approved technician repair the Product.
- Remove the input signals before you clean the Product.
- Do not operate within external low frequency magnetic fields >30A/m.

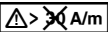
Symbols used on the Product and in this manual are explained in Table 1.

Table 1. Symbols

Symbol	Description	Symbol	Description
	WARNING. RISK OF DANGER.		Battery
	WARNING. HAZARDOUS VOLTAGE. Risk of electric shock.		Certified by CSA Group to North American safety standards.
	Consult user documentation.		Conforms to European Union directives.
	Application around and removal from uninsulated hazardous live conductors is permitted.		Conforms to relevant Australian EMC standards.
	Double Insulated		Certified by TÜV SÜD Product Service.
	Do not operate within external low frequency magnetic fields >30A/m.		Conforms to relevant South Korean EMC Standards.
	China metrology certification mark for measuring instruments manufactured in the People's Republic of China (PRC).		
CAT III	Measurement Category III is applicable to test and measuring circuits connected to the distribution part of the building's low-voltage MAINS installation.		
CAT IV	Measurement Category IV is applicable to test and measuring circuits connected at the source of the building's low-voltage MAINS installation.		
	This product complies with the WEEE Directive marking requirements. The affixed label indicates that you must not discard this electrical/electronic product in domestic household waste. Product Category: With reference to the equipment types in the WEEE Directive Annex I, this product is classed as category 9 "Monitoring and Control Instrumentation" product. Do not dispose of this product as unsorted municipal waste.		

Before You Start

This section is information to know before you use the Clamp.

⚠⚠ Warning

To prevent possible electrical shock, fire, or personal injury:

- **For optimal readings, make sure the conductor is positioned between the alignment marks on the jaws.**
- **Make sure the jaws are perpendicular to the conductor.**
- **Do not use the HOLD function to measure unknown potentials. When HOLD is turned on, the display does not change when a different potential is measured.**
- **Replace the batteries as soon as the low battery indicator appears.**

Power On/Off

The Clamp has a power on/off button:

1. Push **⏻** to turn on the Clamp.
2. Push and hold **⏻** >2 s. to turn off the Clamp.

If Auto-Off Power is turned on, the Clamp turns off after 20 minutes of no use. See *Power Auto-Off* on page 11 for more information about how to set this feature.

Display Features and Controls

See Table 2 and Table 3 for the display features and button controls.

Table 2. Display Features

Item	Description	Item	Description
1	Fluke Connect®	10	Measurement value or custom setting
2	Hold	11	Ohms function
3	ID#	12	Current in mA or A
4	Alarm	13	Current type is AC
5	Set Time	14	Memory in use
6	Indicator for noise in ground electrode/rod	15	Filter is on (bandwidth 40 Hz to 70 Hz)
7	Battery	16	Logging Interval settings
8	Date/Time format	17	Jaws open
9	Date/Time/ID number	18	Setting or explore for LOG

Table 3. Controls

Item	Description
1	Jaw
2	Tactile barrier
3	Fluke Connect® (radio) on/off
4	Record measurements
5	Hold the displayed value
6	LCD
7	Backlight
8	Filter on/off
9	Enter
10	Value increment/decrement
11	Change Clamp settings
12	Select type of measurement
13	Power on/off
14	Alarm
15	Jaw trigger
16	Jaw trigger lock

Setup

Push **SETUP** to change these settings:

- Log interval
- Alarm threshold
- Time
- Clamp settings

Log Interval

The time interval for data logging is the time between measurements.

To set the log interval:

1. Push **SETUP** until **LOG INTERVAL** shows in the display. See Figure 1.

The interval is shown in minutes:seconds format and is adjustable from 00:00 to 59:59.

2. Push **ENTER** to enable the change mode. The digits start to blink.

3. Push **▲** / **▼** to increment/decrement the interval by 1 second.
4. After you select the value, push **ENTER** until the digits stop blinking.
5. Push **A/R** to go back to the measurement mode.

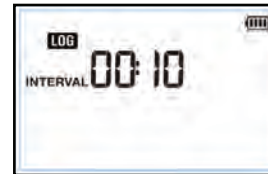

Figure 1. Log Interval

Alarm Threshold

In alarm mode, the display shows **ALARM** and the beeper sounds when the measurement is outside the set threshold. The Clamp compares the reading with the high and low values. If the reading is larger than the high value, the Clamp beeps and shows **HI--** on the display. If the reading is less than the low value, the Clamp beeps and **LO--** shows on the display.

To set the alarm threshold:

1. Push **SETUP** until **ALARM** shows in the display. See Figure 2.
2. Push **ENTER** to select the type as **Amps HI**, **Amps LO**, **Ohms LO**, or **Ohms HI**.
3. Push **▲** / **▼** to increment/decrement the value.
4. Push **ENTER** to confirm the current input and move to the next setting.
5. Push **A/Ω** to go back to the measurement mode.

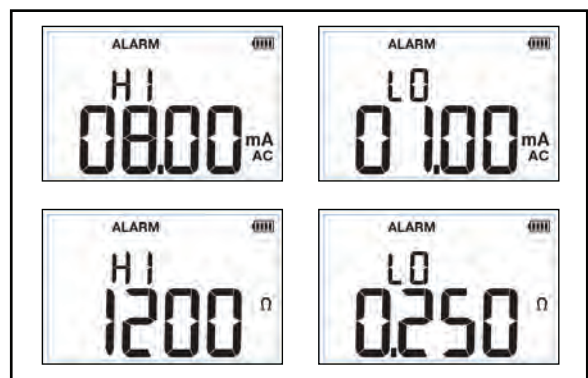

Figure 2. Alarm Functions

Time/Clock

The Clamp has a time setting that is used as a timestamp for logged data.

To check or adjust the time setting:

1. Push **SETUP** until **TIME** shows in the display. See Figure 3.
2. Push **ENTER** until the digit you want to change starts to blink.
3. Push **▲** / **▼** to increment/decrement the value of the blinking digit.
4. After you select the value, push **ENTER** until the digits stop blinking.
5. Push **A/Ω** to go back to the measurement mode.



Figure 3. Time Setting

Clamp Settings

The Clamp has a Setup menu for these subfunctions:

- Backlight auto-off
- Power auto-off
- Firmware version

Backlight Auto-Off

A backlight on the display improves visibility in dim light. To conserve battery power, turn off the backlight.

To change the backlight option:

1. Push **SETUP** until **bl:** shows on the display. See Figure 4.
2. Push **▲** / **▼** to toggle the setting between on and off.

The display updates to show the current setting:

- On: backlight turns off after 2 minutes
- Off: backlight does not turn off

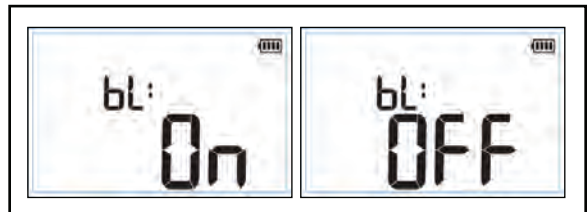

Figure 4. Backlight Setting

3. Push **ENTER** to confirm the current input and move to the next setting.
4. Push **A/Ω** to go back to the measurement mode.

Power Auto-Off

To save battery power, you can set the clamp to automatically turn off the power after 20 minutes of no use.

To change the Auto-Off option:

1. Push **SETUP** until **bl** : shows on the display.
2. Push **ENTER** until **AP** : shows on the display. See Figure 5.
3. Push **▲** / **▼** to toggle the setting between on and off.

The display updates to show the current setting:

- On: Clamp turns off after 20 minutes
- Off: Clamp does not turn off



Figure 5. Auto-Off Power Setting

4. Push **ENTER** to confirm the current input and move to the next setting.
5. Push **A/Ω** to go back to the measurement mode.

Firmware Version

To view the firmware version for the Clamp:

1. Push **SETUP** until **bl** : shows on the display.
2. Push **ENTER** until **uEr** : and the version number shows on the display. See Figure 6.



Figure 6. Firmware Version

3. Push **A/Ω** to go back to the measurement mode.

How to Use the Clamp

This section is about how to set up the Clamp for Earth resistance tests, AC leakage current measurements, and the Fluke Connect® Wireless System.

The Clamp includes a trigger lock on the trigger. Push the jaw trigger lock and trigger together to open the jaw.

Ground Resistance Measurements

The Clamp generates a voltage to the system under test and the induced current in the system is measured by the Clamp. The Clamp uses Ohm's Law ($R=U/I$) to automatically calculate the resistance measurement.

To check the Clamp before ground resistance measurements:

1. Position the Jaw on the Standard Loop Resistance. See Figure 7.

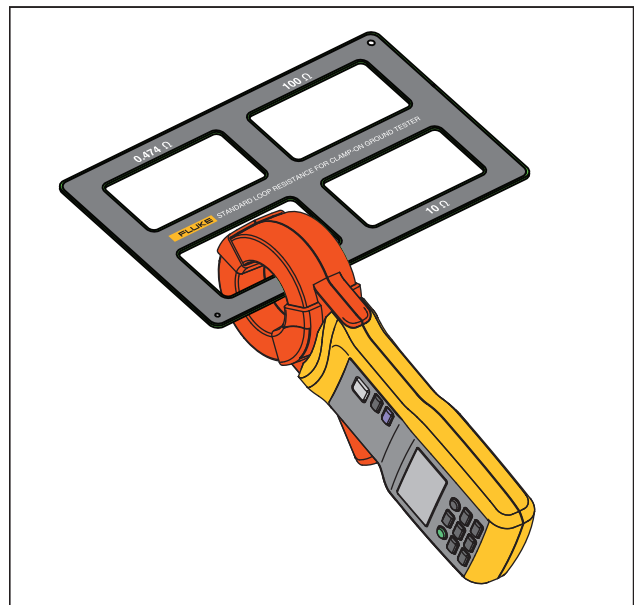

Figure 7. Standard Loop Resistance

2. Verify that the display reading is within specification, see Table 4.
 - If the reading is not within specification, clean the heads of the Jaw and repeat step 1 and step 2.
 - If the reading is within specification, remove the Jaw from the Standard Loop Resistance. The Clamp is ready for a ground resistance measurement.

Table 4. Display Reading Specifications

Input (Ω)	Minimum	Maximum
0.474	0.417	0.531
0.5	0.443	0.558
10	9.55	10.45
100	96.0	104.0

For ground resistance measurements:

1. Open the jaw and make sure the jaw is free of dust, dirt, or any foreign substances.
2. Turn on the Clamp.
3. Push **A/ Ω** to select the Ω function.
4. Attach the Clamp to the electrode or ground rod to be measured.
5. Read the value of R_g (ground resistance) from the display. Figure 8 illustrates the ground resistance measurement principles.

Note

- If >3 A is found in the ground rod, NOISE shows on the display and the Clamp beeps. When noise is present, the Clamp reading is not valid.
- If the jaw assembly is opened during measurement,  shows on the display.

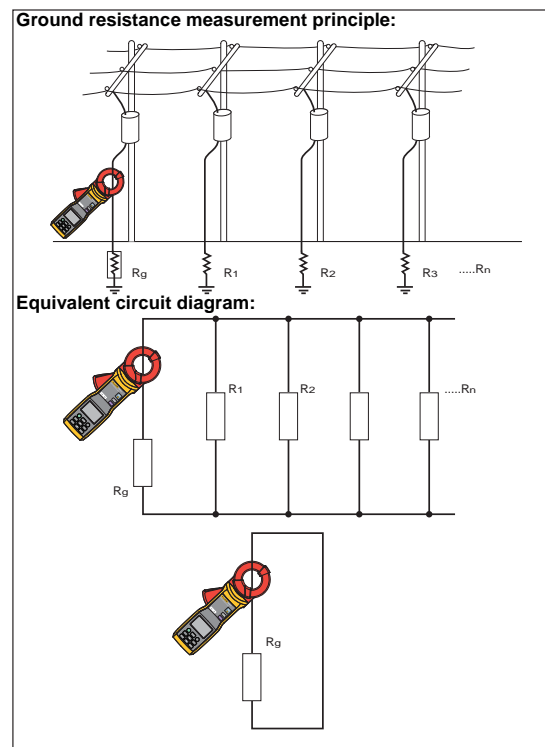

Figure 8. Ground Resistance Measurement Principles

AC Leakage Current Measurement

Based on the electromagnetic induction principle, the Clamp has a ring-shape current transformer comprised of a metal core and coil winding. The current transformer senses the magnetic field produced by the current or by the vector sum of the currents flowing in the conductor under test. The current transformer then produces a current proportional to the current flowing in the conductor.

For an AC leakage current measurement test:

1. Open the jaw and make sure the jaw is free of dust, dirt, or any foreign substances.
2. Turn on the Clamp.
3. Push **A/n** to select the **A** function.
4. Attach the Clamp to the electrode, conductor, or ground rod for measurement. Figure 9 shows several connection types for an AC leakage current measurement.
5. Read the value of the leakage current on the display.

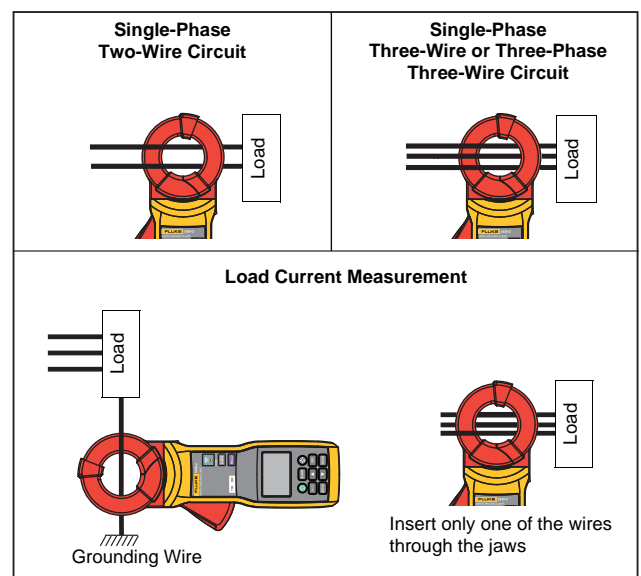

Figure 9. AC Leakage Current Measurement

Logging Measurements

The Clamp records data over time and saves >2000 measurements in memory at the set logging interval.

To start logging measurements, push **LOG**. The display shows **MEM** to indicate that measurement logging is in progress. See Figure 10.



Figure 10. Logging Measurements

Measurements are recorded at the sampling interval you specified. See *Log Interval* on page 8 for more information.

Logging stops when:

- Clamp memory is full
- Clamp detects a low battery
- You push **LOG** again

Note

*If the sampling interval is set at 0 seconds, only one data point is recorded. To record the next data point, press **LOG** again. The memory location is also displayed for about 1 second.*

Hold

Push **HOLD** to freeze the measurement value on the display.

Push **HOLD** again to continue and take measurements.

Filter

Push **BP** to toggle the filter on and off in the leakage current measurement mode. When **BP** shows on the display, the clamp can isolate the 50/60 Hz fundamental frequency from the harmonics.

Fluke Connect Wireless System

The 1630-2 FC supports the Fluke Connect® Wireless System (may not be available in all regions). Fluke Connect® uses low-power 802.15.4 wireless radio technology to connect the Clamp with an app on your smartphone or tablet. The wireless radio does not cause interference with meter measurements.

The app shows measurements from the connected Clamp on your smartphone or tablet display, saves to Fluke Connect Cloud™ storage, and shares the information with your team.

Radio Frequency Data

Note



Changes or modifications to the wireless 2.4 GHz radio not expressly approved by Fluke Corporation could void the user's authority to operate the equipment.

For complete information about radio frequency data, go to and search for “Radio Frequency Data Class B”.

Fluke Connect® App

The Fluke Connect® app works with Apple and Android mobile products. The app is available for download to your smart device from the Apple App Store and Google Play.

To use Fluke Connect:

1. Turn on the Clamp. See Figure 11.
2. Press  to activate the radio on the Clamp.  shows on the display.
3. On your smartphone, go to **Settings > Bluetooth**. Verify that Bluetooth is turned on.
4. Go to the Fluke Connect App and in the list of connected Fluke tools, select **1630-2FC**. You can now take, save, and share measurements with the app. Go to [Fluke Connect App](#) for more information about how to use the app.

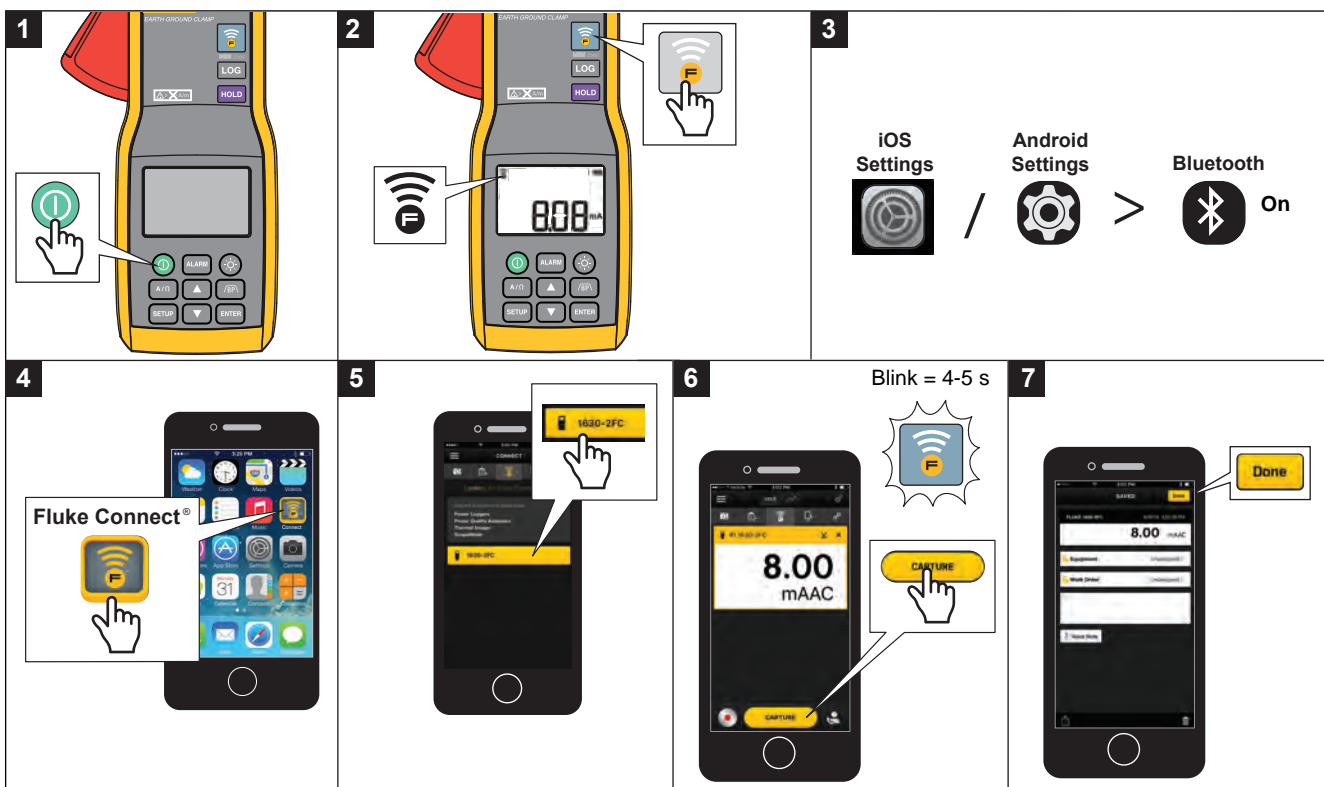

Figure 11. Fluke Connect®

Memory

You can log >2000 measurements in the Clamp memory.

View Memory

To view logged measurements in memory:

1. Push and hold **LOG** >2 s to go the view memory mode.

The most recent logged measurement shows on the display with an ID#. See Figure 12.



Figure 12. Logged Measurements

2. Press **▲** / **▼** to go to the next or previous ID# (memory location). The ID# rolls over when you reach the first or last record.
3. Push **ENTER** to toggle the display to show the time or date for the logged measurement. See Figure 13.

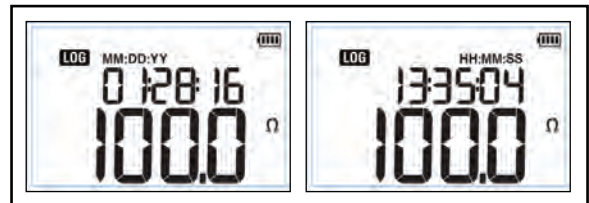

Figure 13. Timestamp

Clear Memory

To clear the memory:

1. In measurement mode, simultaneously push and hold **▲** / **▼**.
2. Push **ENTER** to confirm and finish the clear action.

The clamp automatically goes back to measurement mode.

Maintenance

⚠⚠ Warning

To prevent a possible electrical shock, fire, or personal injury:

- Do not operate the Product with covers removed or the case open. Hazardous voltage exposure is possible.
- Repair the Product before use if the battery leaks.
- Use only specified replacement parts.
- Have an approved technician repair the Product.
- Remove the input signals before you clean the Product.
- Do not use the HOLD function to measure unknown potentials. When HOLD is turned on, the display does not change when a different potential is measured.

Clamp Care

⚠ Caution

To avoid damaging the Clamp, do not use aromatic hydrocarbons or chlorinated solvents for cleaning. These solutions will react with the plastics used in the Clamp.

Clean the case with a damp cloth and weak detergent. Do not use a solvent or cleaners with abrasives.

Battery Replacement

⚠⚠ Warning

To avoid false readings that could lead to possible electric shock or personal injury, replace the batteries as soon as the low battery indicator () appears.

To replace the battery:

1. Push and hold  >2 s to turn off the Clamp.
2. See Table 5 for details on how to replace the battery.

Parts and Accessories

Read this manual to make sure the Product is used correctly. If the Clamp does not turn on, check the battery.

Replacement parts and accessories are shown in Table 5. For more information about parts and accessories, see *How to Contact Fluke* on page 1.

Table 5. Accessories and Replacement Parts

Item	Description	Fluke Part or Model Number
1	AA Alkaline Battery, IEC LR6 (requires 4)	373756
2	Battery Door Assembly	4779851
3	Standard Loop Resistance	4799496

Electrical Specifications

Maximum Voltage to Earth Ground	1000 V
Battery Type	AA alkaline IEC LR6 (x4)
Battery Life	>15 hours in Ground Resistance measurement mode, with backlight turned off, and RF mode turned off
Frequency Range	
Filter OFF	40 Hz to 1 kHz
Filter ON	40 Hz to 70 Hz
Ingress Protection	IEC 60529: IP30 with jaw closed
LCD	
Digital Reading	9999 counts
Refresh Rate	4/second
Temperature	
Operating	-10 °C to +50 °C
Storage	-20 °C to +60 °C
Operating Humidity	Non condensing (<10 °C) ≤90 % RH (at 10 °C to 30 °C) ≤75 % RH (at 30 °C to 40 °C) ≤45 % RH (at 40 °C to 50 °C) (noncondensing)
Altitude	
Operating	2000 m
Storage	12 000 m
Reference Temperature	23 °C ±5 °C (73 °F ±9 °F)
Temperature Coefficient	0.15 % x reading/ °C (<18 °C or >28 °C)

Overload Indication OL
Data Logging Capacity >2000 data points
Data Logging Interval 1 second to 59 minutes and 59 seconds

Safety

General IEC 61010-1: Pollution Degree 2
IEC 61557-1
Measurement IEC 61010-2-032: CAT IV 600 V /
CAT III 1000 V
Current Clamp for Leakage Current
Measurements IEC 61557-13: Class 2, ≤30 A/m
Resistance to Earth IEC 61557-5
Effectiveness of the Protective Measures IEC 61557-16: cutoff frequency 20 kHz (-3 dB)

1630-2/1630-2 FC
Users Manual

Electromagnetic Compatibility (EMC)

International IEC 61326-1: Portable Electromagnetic Environment
CISPR 11: Group 1, Class B, IEC 61326-2-2

Group 1: Equipment has intentionally generated and/or uses conductively-coupled radio frequency energy that is necessary for the internal function of the equipment itself.

Class B: Equipment is suitable for use in domestic establishments and in establishments directly connected to a low voltage power supply network which supplies buildings used for domestic purposes.

Emissions that exceed the levels required by CISPR 11 can occur when the equipment is connected to a test object.

Korea (KCC) Class A equipment (Industrial Broadcast & Communications Equipment)

Class A: Equipment meets requirements for industrial electromagnetic wave equipment and the seller or user should take notice of it. This equipment is intended for use in business environments and not to be used in homes.

USA (FCC) 47 CFR 15 subpart B. This product is considered an exempt device per clause 15.103.

Wireless Radio

Frequency Range 2412 MHz to 2462 MHz

Output Power <10 mW

Radio Frequency Certification FCC ID:T68-FBLE IC:6627A-FBLE

General Specifications

Conductor Size 40 mm approximately

Dimensions (L x W x H) 283 mm x 105 mm x 48 mm

Weight 880 g

Ground Loop Resistance

Frequency of measurement: 3.333 kHz.

Range	Accuracy ^[1] ± (% of reading + Ω)
0.025 Ω to 0.249 Ω	1.5 % + 0.020 Ω
0.250 Ω to 0.999 Ω	1.5 % + 0.050 Ω
1.000 Ω to 9.999 Ω	1.5 % + 0.100 Ω
10.00 Ω to 49.99 Ω	1.5 % + 0.30 Ω
50.00 Ω to 99.99 Ω	1.5 % + 0.50 Ω
100.0 Ω to 199.9 Ω	3.0 % + 1.0 Ω
200.0 Ω to 399.9 Ω	5.0 % + 5.0 Ω
400 Ω to 599 Ω	10.0 % + 10 Ω
600 Ω to 1500 Ω	20.00 %
[1] Loop resistance with no inductance, conductor centered.	

AC Leakage Current mA

True rms, crest factor CF ≤3

Range	Resolution	Accuracy ^[1] ± (% of reading + mA)
0.200 mA to 3.999 mA	1 μA	2.0 % + 0.05 mA
4.00 mA to 39.99 mA	10 μA	2.0 % + 0.03 mA
40.0 mA to 399.9 mA	100 μA	2.0 % + 0.3 mA
0.400 A to 3.999 A	1 mA	2.0 % + 3 mA
4.00 A to 39.99 A	10 mA	2.0 % + 30 mA
[1] Applies to signal frequency: <ul style="list-style-type: none"> • 40 Hz to 1 kHz with Filter set to OFF • 40 Hz to 70 Hz with Filter set to ON 		