



1368  
1369  
1370

**Triple Output Programmable Power Supplies**

**User Manual**

## Table of Contents

Safety .....	3
Compliance and Certifications.....	7
Introduction.....	8
Product Overview .....	9
Front Panel.....	9
Rear Panel.....	10
Display.....	11
Operation.....	12
Setting the Voltage and Current .....	12
CH SET .....	13
CH File.....	14
Menu Set .....	14
Specifications .....	16
Interface and Communication.....	17
RS-232 Interface .....	17
USB TMC .....	19
USB CDC Virtual Serial Port .....	21
Command Structure .....	21
SCPI Command.....	22
Limited One-Year Warranty .....	27
Service.....	28

© 2019 Global Specialties. All rights reserved.

Unauthorized duplication of Global Specialties documentation materials is strictly prohibited. Customers are permitted to duplicate and distribute Global Specialties documentation for internal educational purposes only.

## Safety

To avoid personal injury and/or product damage, review and comply with the following safety precautions. These precautions apply to both operating and maintenance personnel and must be followed during all phases of operation, service, and repair of this meter. Before applying power be sure to:

- Read and understand the safety and operational information in this manual.
- Apply all the listed safety precautions.
- Verify that the voltage selector on the bottom of the power supply is set to the correct line voltage. Operating the instrument at an incorrect line voltage will void the warranty.
- Make all connections to the instrument before applying power.
- Do not operate the instrument in ways not specified by this manual or by Global Specialties.

Failure to comply with these precautions or with warnings elsewhere in this manual violates the safety standards of design, manufacture, and intended use of the instrument. Global Specialties assumes no liability for a customer's failure to comply with these requirements.

### ***Dry Conditions***

Hands, shoes, floor, and work bench must be dry. Avoid making measurements with dampness, or other environmental conditions that might affect safety.

### ***Cleaning***

Use a soft cotton cloth lightly moistened with a mild solution of detergent and water. Do not allow any portion to be submerged at any time. Dry thoroughly before attempting to make measurements. Do not use solvents or expose to solvent fumes as they may cause deterioration or damage.

### ***Do not Operate:***

- In the presence of noxious, corrosive, flammable fumes, gases, vapors, chemicals, or finely-divided particulates.
- In environments where there is a danger of any liquid being spilled on the meter.
- In air temperatures exceeding the specified operating temperatures.
- In atmospheric pressures outside the specified altitude limits or where the surrounding gas is not air.

Only for use in pollution degree 2 environments where non-conductive pollution occurs except occasionally when a temporary conductivity caused by condensation is expected.

### **Definitions**

MEASUREMENT CATEGORY - Classification of testing and measuring circuits according to the types of mains circuits to which they are intended to be connected.

- MEASUREMENT CATEGORY I (CAT I): Measurement instruments whose measurement inputs are not intended to be connected to the mains supply. The voltages in the environment are typically derived from a limited-energy transformer or a battery.
- MEASUREMENT CATEGORY II (CAT II) - measuring circuits connected directly to utilization points of the low-voltage mains installation.
- MEASUREMENT CATEGORY III (CAT III) - measuring circuits connected to the distribution part of the building's low-voltage mains installation.
- MEASUREMENT CATEGORY IV (CAT IV) - measuring circuits connected at the source of the building's low-voltage mains installation

Do not use this instrument in an electrical environment with a higher category rating than what is specified in this manual for this instrument. You must ensure that each accessory you use with this instrument has a category rating equal to or higher than the instrument's category rating to maintain the instrument's category rating. Failure to do so will lower the category rating of the measuring system. **Working CAT rating is equal to that of the lowest rated element within the test set-up.**

### **Electrical Power**

This instrument is intended to be powered from a CATEGORY II mains power environment. The mains power should be 110 V RMS or 220 V RMS. Use only the power cord supplied with the instrument and ensure it is appropriate for your country of use. Use only type T10AL 250 V fuses. To switch between 110/220 V settings, slide the switch on the bottom of the unit.

### **Ground the Instrument:**

To minimize shock hazard, the instrument case must be connected to an electrical safety ground. This instrument is grounded through the ground conductor of the supplied, three-conductor AC power cable. Do not alter or defeat the ground connection. Without the safety ground connection, all accessible conductive parts (including control knobs) may provide an electric shock. Failure to use a properly-grounded approved outlet and the recommended three-conductor AC line power cable may result in injury or death. Unless otherwise stated, a ground connection on the instrument's front or rear panel is for a reference of potential only and is not to be used as a safety ground.

### ***Indoor Use:***

This instrument is intended to be used in an indoor pollution degree 2 environment. The operating temperature range is 0 °C to 40 °C and the operating humidity range is up to 80% relative humidity with no condensation allowed. Measurement results may be outside specifications if the instrument is used in non-office-type environments. Such environments may include rapid temperature or humidity changes, sunlight, vibration and/or mechanical shocks, acoustic noise, electrical noise, strong electric fields, or strong magnetic fields.

### ***Do not Operate:***

If the instrument is damaged, appears to be damaged, or if any liquid, chemical, or other material gets on or inside the instrument, remove the instrument's power cord, remove the instrument from service, label it as not to be operated, and return the instrument to Global Specialties for repair. Notify Global Specialties of the nature of any contamination of the instrument.

### ***Not for Critical Applications:***

This instrument is not authorized for use in contact with the human body or for use as a component in a life-support device or system.

### ***Do not Touch Live Circuits***

### ***Do not Attempt Servicing:***

Instrument covers must not be removed by operating personnel. Component replacement and internal adjustments must be made by qualified service-trained maintenance personnel who are aware of the hazards involved when the instrument's covers and shields are removed.

Under certain conditions, even with the power cord removed, dangerous voltages may exist when the covers are removed. To avoid injuries, always disconnect the power cord from the instrument, disconnect all other connections (for example, test leads, computer interface cables, etc.), discharge all circuits, and verify there are no hazardous voltages present on any conductors by measurements with a properly-operating voltage-sensing device before touching any internal parts. Verify the voltage-sensing device is working properly before and after making the measurements by testing with known-operating voltage sources and test voltages. Do not attempt any service or adjustment unless another person capable of rendering first aid and resuscitation is present. Hazardous voltages may be present in unexpected locations in circuitry being tested when a fault condition in the circuit exists

***Do not insert any object into an instrument's ventilation openings or other openings.***

### **Servicing**

Do not substitute parts that are not approved by Global Specialties or modify this instrument. Return the instrument to Global Specialties for service and repair to ensure that safety and performance features are maintained.

### **Cooling fans**

This instrument contains one or more cooling fans. For continued safe operation of the instrument, the air inlet and exhaust openings for these fans must not be blocked nor must accumulated dust or other debris be allowed to reduce air flow. Maintain at least 25 mm clearance around the sides of the instrument that contain air inlet and exhaust ports. If mounted in a rack, position power devices in the rack above the instrument to minimize instrument heating while rack mounted. Do not continue to operate the instrument if you cannot verify the fan is operating (note some fans may have intermittent duty cycles). Do not insert any object into the fan's inlet or outlet.

### **Use Correctly Sized Wires:**

To connect a load to the power supply, use a wire diameter large enough to handle the maximum continuous output short-circuit current of the power supply without the wire overheating.

For continued safe use of the instrument

- Do not place heavy objects on the instrument.
- Do not obstruct cooling air flow to the instrument.
- Do not place a hot soldering iron on the instrument.
- Do not pull the instrument with the power cord, connected probe, or connected test lead.
- Do not move the instrument when a probe is connected to a circuit being tested

### **Safety Notes and Symbols**

**WARNING** A warning statement calls attention to an operating procedure, practice, or condition, which, if not followed correctly, could result in injury or death to personnel.

**CAUTION** A caution statement calls attention to an operating procedure, practice, or condition, which, if not followed correctly, could result in damage to or destruction of parts or the entire product.

The following symbol may appear on the product or in its documentation:



Caution, see documentation for details

---

## **Compliance and Certifications**

### ***CE Compliance***

This product meets the essential requirements of the applicable European Directives as follows:

- 2004/108/EC: Electromagnetic Directive (EMC)
- 2006/95/EC: Low Voltage Directive (LVD)

### ***Disposal***



(Applicable in the European Union and other European countries with separate collection systems). This product is subject to Directive 2012/19/EU of the European Parliament and the Council of the European Union on waste electrical and electronic equipment (WEEE), and in jurisdictions adopting that Directive, is marked as being put on the market after August 13, 2005, and should not be disposed of as unsorted municipal waste. Please utilize your local WEEE collection facilities in the disposition of this product.

### Introduction

#### Overview

The Performance Series (Models 1368, 1369, 1370) are linear triple output power supplies with fully programmable isolated outputs. These outputs can be adjusted independently or combined in series or parallel to output higher voltage or current. Each model offers a different variable output voltage and current on two channels. The third channel is rated at 6 volts, 5 amps. These supplies offer tracking mode with user-configurable ratios between channels, access to a timer controlled output function, and store/recall on up to 40 instrument settings per channel. Connecting to a PC by USB or RS-232 enables remote instrument control using industry standard protocols.

#### Features:

- Three independent and fully isolated channels
- Series and parallel modes connect channels to maximize output voltage or current
- Fully programmable channels with Output On/Off control
- Simultaneous display of voltage and current settings on all three channels
- High programming and readback resolution of 1 mV / 0.1 mA
- Low ripple, noise, load, and line regulation
- Save and recall up to 40 instrument settings
- USB connector for firmware updates
- Remote sense
- Timer-controlled output function adjustable from 0.1 – 9999.9 s
- Tracking mode maintains a programmed ratio for connected channels
- PC connection/control through RS-232 or USB supporting standard SCPI commands
- Intelligent fan control, energy saving and noise reduction
- Overvoltage (OVP) and overcurrent (OCP) protection
- Keylock function

#### Initial Inspection

These units are tested prior to shipment but an initial physical inspection should be made to ensure that no damage has been sustained during shipment. After the inspection, verify the contents of the shipment. The included items for this product are:

- Power Supply
- AC Power Cable
- (2) 250 V Slow Blow Glass Fuses
- Certificate of Calibration and Test Report



## Product Overview

### Front Panel

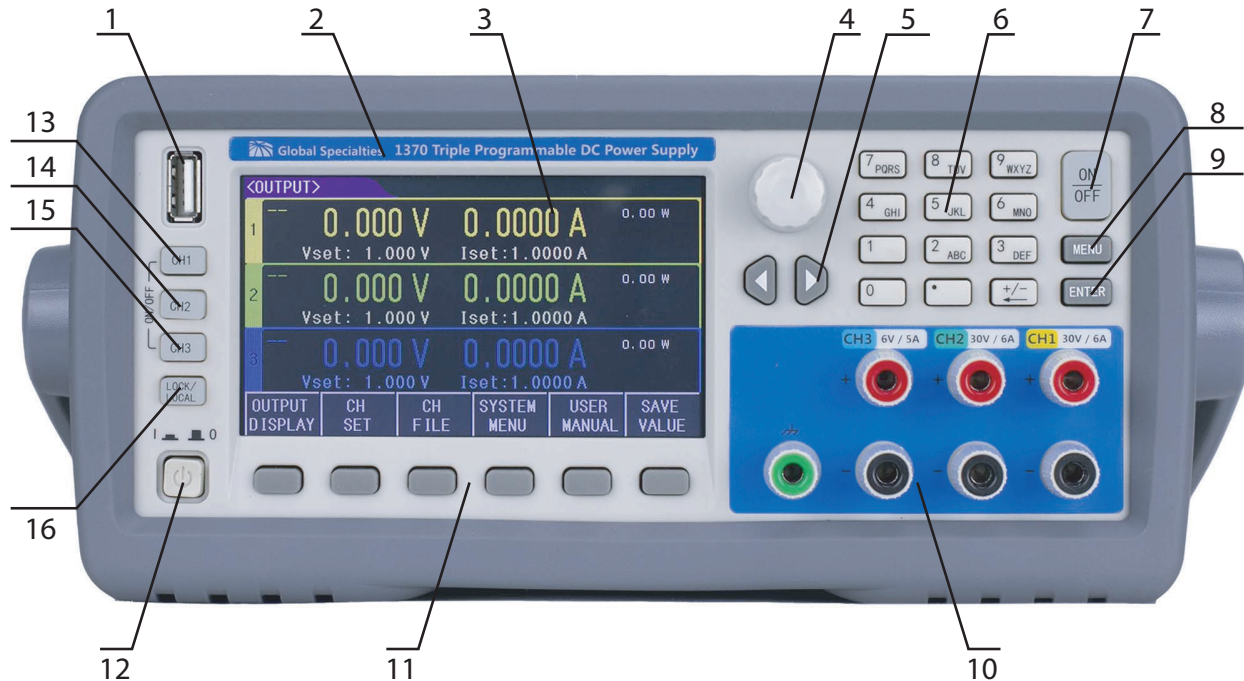

1. USB interface to update firmware
2. Model name and number
3. LCD display, 480 × 272 pixels, 24-bit color, 4.3-inch color TFT LCD screen
4. Adjustment knob, selection tool and fine adjustments
5. Arrow keys for moving the cursor
6. Numeric keys to input the specific values
7. [ON/OFF] key to turn on or off the three channel outputs simultaneously
8. [MENU] key for quick access to menu interface
9. [ENTER] key to input the data and can be used with the [LOCK/LOCAL] key to take screenshots
10. Output terminals, channels 1, 2, and 3 from right to left
11. Soft keys to set the display content
12. Power switch to power the unit on or off
- 13-15. Output keys to individually turn on each of the channel outputs
16. [LOCK/LOCAL] key to lock the keys or switch from remote to local control. Can be used with the [ENTER] key to take screenshots

## Rear Panel

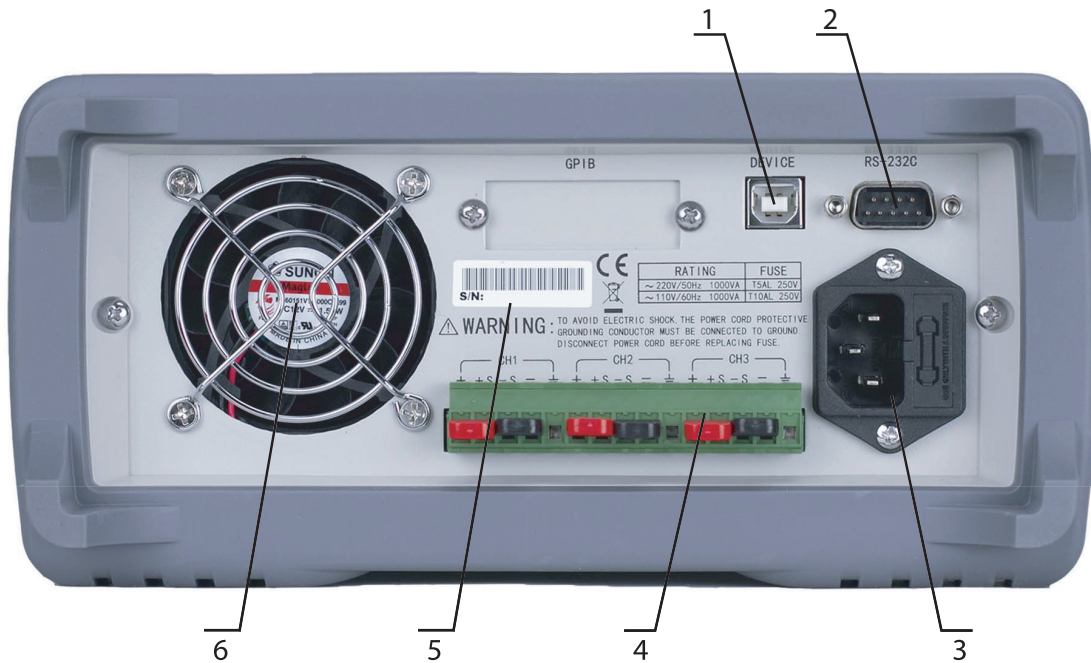

1. USB Interface for communication by PC via USB DEVICE
2. RS-232 Function is same as USB
3. Power socket connecting 115/230 V 50 Hz AC power supply
4. Remote test terminal adds same function as output in front panel, 4-terminal sampling function is added for remote sense
5. Serial number
6. Thermostatically controlled fan

## Display

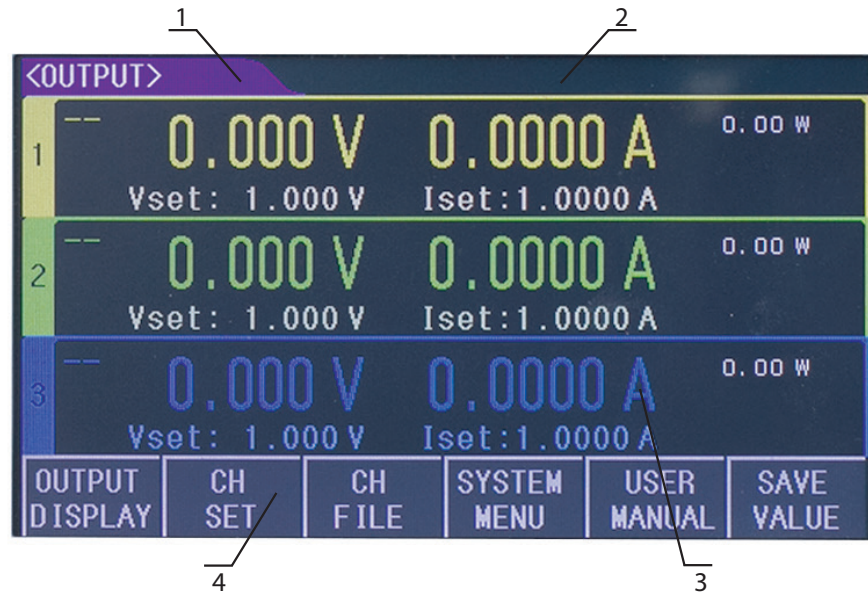

1. Display menu to display the name of current page
2. Status and error information to display the error information or current working status.
3. Quick setting and display where to set the voltage, current. Real time sampling numbers and timing will also be displayed
4. Soft key menu options update on display for each menu

## Operation

- Power on the unit and let warm up for 25 minutes.
- Select the proper connection cable/wire.
- Connect the load to the [+,-] terminal on the power supply.
  - In Series or Parallel modes, the connection cable in the output terminal must be connected in series or parallel. This also applies for rear panel connections.
- Set the working mode and output parameters and press the corresponding CH key to output or press ON/OFF for all 3 channels to output simultaneously.

## Output Display

Press OUTPUT DISPLAY to enter <OUTPUT> page

<OUTPUT> is displayed as below

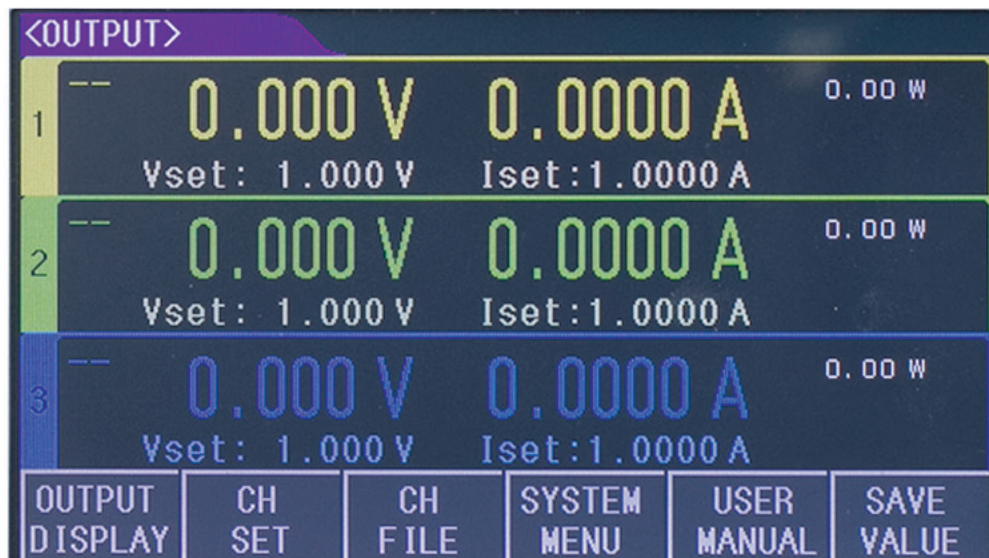

You can set the voltage and current for all 3 channels. Here the measured voltage, current, power, output time and output status are displayed.

## Setting the Voltage and Current

The setting range of voltage and current in each channel is from 0 to the MAX value (The MAX value is decided by different models). Use the direction key or adjustment knob to move the cursor to the desired setting then set voltage or current one of two ways:

A: Press knob and rotate it to adjust the value

B: Use number key to input the value, select the unit on the bottom zone or use

ENTER to input the voltage or current value.

## Output

The CH1, CH2, CH3 buttons on the left of panel are matched with output on or off in the 3 channels. When the parameter is set on one channel press the output; the button will light up blue. To turn off the channel press the button again. The output will turn off and the indicator will turn off. The ON/OFF button is used to turn on and off the output of all 3 channels simultaneously.

## CH Set

Press CH SET to enter CH1 individually. Here you may switch and set another channel by pressing the ◀CH or CH▶ buttons.

CH1 SET is displayed as below:

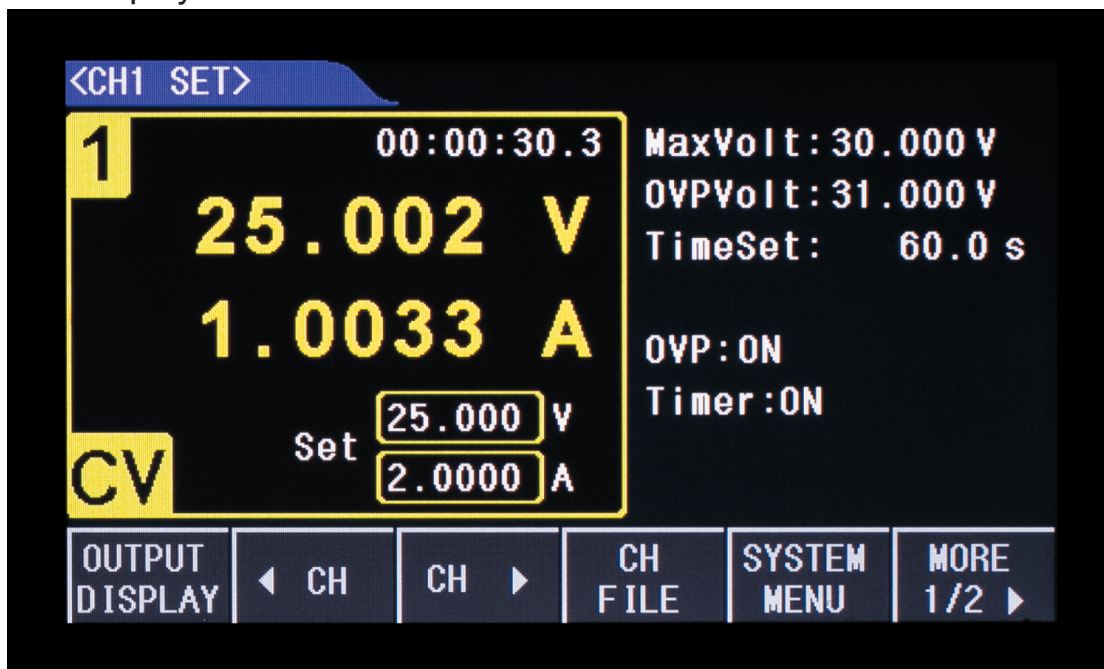

On this page the following parameters may be set:

- Voltage, current
- Max Volt - sets the upper voltage limit
- OVP Volt - sets the upper voltage limit, will turn output off if voltage surpasses this level.
- Time Set - sets the timer value from 0 to 99999.9s for the output, when time runs out the output is turned off.
- OVP - Turns the Over Voltage Protection on or off
- Timer - Turns the timer on or off

- SAVE VALUE - Saves the parameters in the CH File for the current channel.

### CH File

Press CH FILE to enter <CH1 FILE>. This page is used to recall or delete the saved data for the specified channel. Up to 40 groups of data can be saved for each channel including all outputs as a group.

### Recall and Delete

There are 4 pages in CH FILE with 10 groups of data on each page. Use the direction key or PAGE UP and PAGE DOWN to check the data.

To recall data, use knob to select the item then press RECALL. The settings for the specified channel will now be updated accordingly. To delete this group select DELETE.

NOTE: The CH FILE is only temporary storage. All data will be cleared when the device is powered off. The data sets can be saved to internal flash memory to preserve them. To save and load the saved data from internal memory, refer to menu set.

### Menu Set

Press the MENU key to enter <SYSTEM>. Listed below are the menu options available:

- Language
  - Chinese
  - English
- Key voice - turns the beep on and off
  - ON
  - OFF
- P-Mem
  - DEFAULT - factory setting
  - USER DATA - saves settings, saved data, and system settings to internal flash memory to be reloaded after power off and on. If there is any change, press the USER DATA again to rewrite all data.
- R-Wait - returns display to main output display automatically after a set time and no live output
  - Off
  - 5s, 30s, 60s
- Bus Mode - there are three types of communication ports
  - RS-232
  - USB-CDC

- USB-TMC
- Baud Rate - the rate at which information is transferred. The higher the baud rate, the more sensitive the cable is to length and connection quality.
  - 4800
  - 9600
  - 19200
  - 38400
  - 57600
  - 115.2k
- Combine - sets series, parallel, or tracking modes
  - Off - turn off combine
  - Series - puts CH1+CH2 in series mode. The voltage will sum and the set current is equal.
  - Para - allows for CH1+CH2 in parallel, CH2+CH3 in parallel, or all 3 channels in parallel, when the set voltage is same and the current will sum.
  - Track - allows for CH1+CH2 in tracking mode, CH2+CH3 in tracking mode, or all 3 channels in tracking mode. In this mode, the set voltage and current are changed based on current ratio. Before selecting this mode, the voltage and current must be set in advance.
    - If the set voltage/current is 0 before selecting the TRACK, tracking will fail
- Date
  - These power supplies have an internal RTC clock. To set the real time display, move the cursor to this item and press SET, then you can set the year, month, date, hour, minute, and second

## Specifications

All specifications apply to the unit after a temperature stabilization time of 20 minutes over an ambient range of 20°C ± 5°C.

<b>Electrical</b>											
Model		1368			1369			1370			
Rated Output (0°C to 40°C)	Channel	CH1	CH2	CH3	CH1	CH2	CH3	CH1	CH2	CH3	
	Voltage	0 to 30 V		0 to 6 V	0 to 60 V		0 to 6 V	0 to 30 V		0 to 6 V	
	Current	0 to 3 A		0 to 5 A	0 to 3 A		0 to 5 A	0 to 6 A		0 to 5 A	
	Power	210 W			390 W			390 W			
Load Regulation ± (% Output + Bias)	Voltage	≤0.01 % + 3 mV									
	Current	≤0.01 % + 3 mA									
Line Regulation ± (% Output + Bias)	Voltage	≤0.01 % + 3 mV									
	Current	≤0.01 % + 3 mA									
Programming Resolution	Voltage	1 mV									
	Current	0.1 mA									
Read-back Value Resolution	Voltage	1 mV									
	Current	0.1 mA									
Drift (0°C to 40°C) ± (% Output + Bias) per year	Program.	Voltage	≤0.03 % + 10 mV								
		Current	≤0.1% + 5 mA	≤0.1% + 8 mA	≤0.1% + 5 mA	≤0.1% + 8 mA	≤0.1% + 5 mA	≤0.1% + 8 mA			
	Read-back	Voltage	≤0.03 % + 10 mV								
		Current	≤0.1% + 5 mA	≤0.1% + 8 mA	≤0.1% + 5 mA	≤0.1% + 8 mA	≤0.1% + 5 mA	≤0.1% + 8 mA			
Ripple and Noise (20 Hz to 20 MHz)	Normal Voltage Mode	≤ 3 mVp-p			≤ 4 mVp-p						
	Normal Current Mode	≤ 3 mArms	≤ 5 mArms	≤ 4 mArms	≤ 5 mArms	≤ 4 mArms	≤ 5 mArms				
Temperature Factor	Voltage	≤0.02 % + 5 mV									
	Current	≤0.1 % + 5 mA									
Series / Parallel Accuracy	Voltage	≤0.02 % + 5 mV			≤0.02 % + 10 mV			≤0.02 % + 5 mV			
	Current	≤0.1 % + 20 mA			≤0.1 % + 30 mA						
Timer		0.1 to 99999.9 s									
Memory		4 groups of 40 data sets									



<b>Mechanical and Environmental</b>			
Model	1368	1369	1370
Weight (lbs)	17.9	28.7	
Dimensions ( L x W x H in)	17 x 10.5 x 4.5	19.2 x 10.5 x 4.5	
Normal Working Temperature (°C)	0 to 40, <90% RH		
Reference Working Temperature (°C)	20 ± 8, <80% RH		
Pollution Degree	2		

<b>Safety</b>			
Model	1368	1369	1370
Insulation Safety (between power terminal and shell)	≥ 50 MΩ for reference conditions ≥ 2 MΩ for hot and humid, non ideal conditions		
Dielectric Strength (between power terminal and shell)	1.5 kV @ 50 Hz line AC for 1 minute		
Leakage Current	< 3.5 mA		
Electromagnetic Compatibility	GB6833.4 GB6833.6 GB6833.10		
Electrical Safety	IEC 61010-1, CAT II		

### Interface and Communication

RS-232 and USB are available in these power supplies, which can be used for data communication and remote control. These cannot be used at the same time. The commands are the same for all ports, however the hardware configuration and communication protocol is different.

### RS-232 Interface

RS-232 standard, also called as a tracking serial communication standard, has been widely used for data communication between computers and computers to external equipment. RS is the English abbreviation of Recommended Standard; 232, the standard number. This standard is created by EIA in 1969, which rules to send one bit in a data line every time.

As most serial interfaces, the serial interface of this series is also not strictly based on RS-232 standard but only uses the smallest subset of this standard. The signals are listed as followings:

## RS-232 Interface

Signal	Code	Connector Pin Number
Transmitted Data	TXD	3
Recieved Data	RXD	2
Signal Ground Common	GND	5

Note: The pin-out of these power supplies is the same as the standard 9-core connector. The 9-core DB type socket of RS-232 in these power supplies is as below:

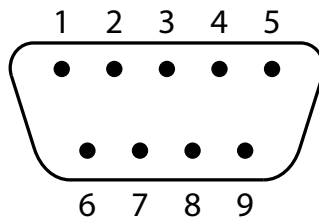

The standard 9-core DB type plug can be used directly



**WARNING** Power supply must be cut when connecting and disconnecting the connector to avoid the electrical shock.

**WARNING** Do not short the output terminal, or with body to avoid damage to the components.

Below is the connection to the PC interface:

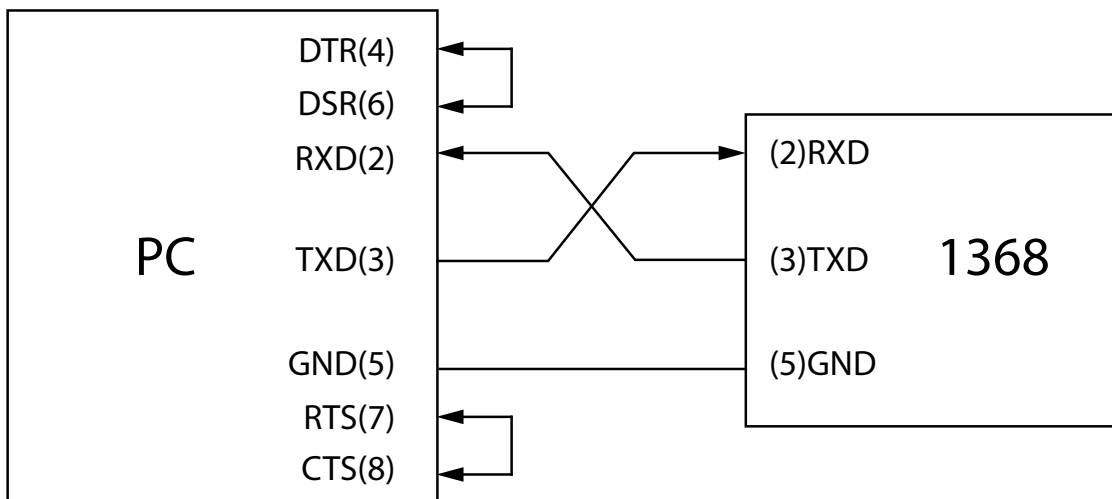

**Communicate with PC**

Based on the table above, the pin-out of these supplies is the same as the 9-core connector of IMB AT. The user can make 3 wire connection cables (length is less than 1.5 m) by using double core shielding wire. For custom cables, please note Pin 4 and 6 and Pin 7 and 8 must be shorted in PC interface. Please set the bus mode to RS-232 in SYSTEM.

<b>RS-232 Parameters</b>	
Transmission Mode	Full Duplex asynchronous communication including start and stop bit
Baud Rate	9600 bps
Data Bit	8 BIT
Stop Bit	1 BIT
Verification	None
End Symbol	NL (line break, ASCII code 10)
Contact	Software
Connector	DB9 core

**USB TMC**

USB remote control system can control the device via USB interface. The communication meet the protocol of USBTMC-USB488 and USB 2.0 for Test and Measurement Control.

- Connect the USB interface on the rear panel of device to the USB interface in PC via USB cable. Select the bus mode to “USBTMC” on the power supply. Reboot is necessary for the choice to reflect on the PC if switching from USB CDC.
- On Windows both interfaces require the free installation of NI-VISA software, before connecting the device for the first time. <https://www.ni.com/en-us/support/downloads/drivers/download/packaged.ni-visa.329456.html> On Linux only USBTMC requires the NI-VISA software.
- After the NI-VISA software is installed and the computer is restarted, connect the device to the PC through a USB cable (2.0 or 3.0).

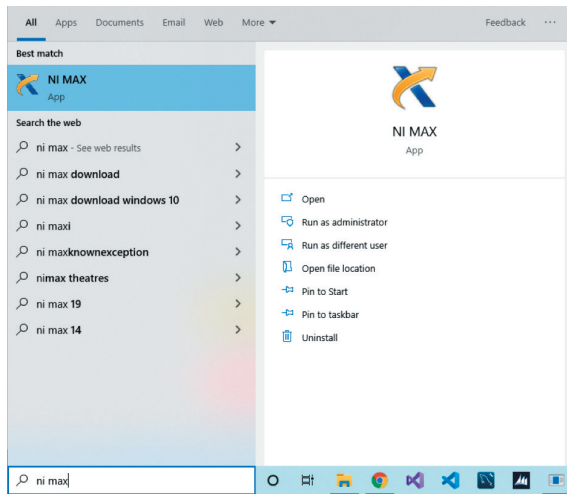

- Open NI MAX and expand the “Devices and Interfaces” tree view

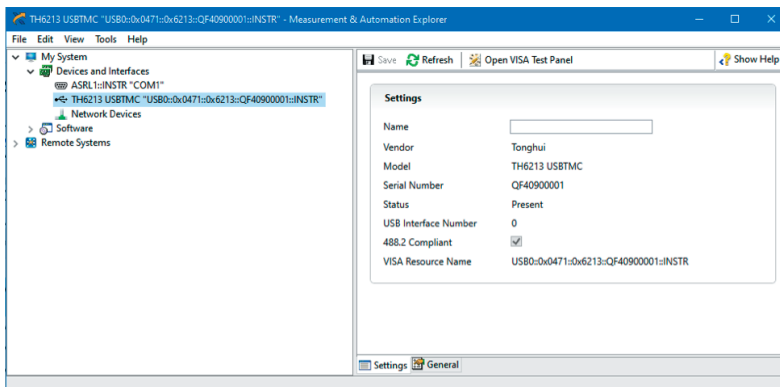

## Commands

In this device, SCPI commands are referred. SCPI is a tree structure with 3 levels at most, where the top level is called subsystem command. Only subsystem is selected, then the bottom level is valid, use the colon to separate the structure.

## Execute Commands in NI-VISA

- Select the device under the “Devices and Interfaces” tree view, and click “Open VISA Test Panel”.
- Then click Next, select the routine of the driver provided by us then Next
- When the driver is installed, you can see USB Test and Measurement Device in the device manager.

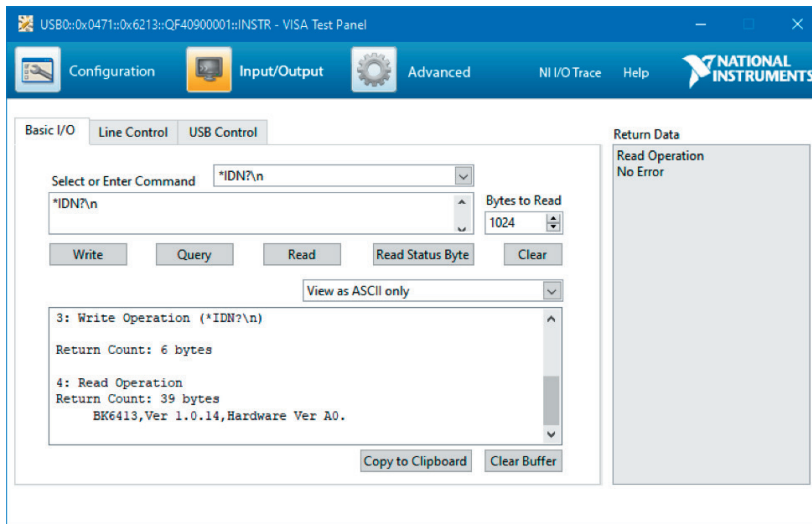

## USB CDC Virtual Serial Port

Select the bus mode to “USBCDC” on the power supply. Reboot is necessary for the choice to reflect on the PC if switching from USBTMC. This makes USB interface configure as Vcom

### Configuration

- Connect the USB interface on the rear panel of device to the USB interface in PC via USB cable.
- Install the driver same as USBTMC (if not already installed)
- Now USB V Com port can be considered as a serial port, when there is no serial port in PC, the communication software based on serial port can also be used as USB virtual serial port in this mode.

### Command Structure

In this device, SCPI commands are referred. SCPI is a tree structure, and there are 3 levels at most, where the top level is called subsystem command. Only subsystem is selected, then the bottom level is valid, use the colon to separate the structure.

### Basic Rule of Command Structure

- Ignore uppercase letter and lowercase letter
  - Example: FUNC:IMP CPD = func:imp cpd = Func:Imp CpD
- Blank space is used to divide command and parameter; the command is in front and behind blank it is the parameter

- Example: FUNC:IMP CPD, IMP is the command and CPD is its parameter.
- There is no parameter in some command
  - Example: SYSTem:LOCK
- Blank space ( ) can't be put in front or behind colon.
  - Example: FUNC\_:IMP CPD FUNC:IMP CPD
- Command can be abbreviation or can be full spelling
  - Example: FUNCTION:IMPEDANCE CPD = FUNC:IMP CPD
- Question mark(?) is behind the command, execute an inquire to the command
  - Example: FUNC:IMP?

### SCPI Command

The following commands are supported without distinguishing uppercase or lowercase letter, and the part of lowercase character can be omitted. In < >, there is detailed parameter and no need to input < > “|” is used to divide the parameter

- SYSTem command
  - SYSTem:LOCAL
    - Set the local operation, now keys on front panel are available
  - SYSTem:BEEPer
    - Test if the beeper can work
  - SYSTem:LOCK?
    - Inquire the control status, return lock or local
  - SYSTem:ADDRess?
    - Inquire the address of this device, return an address value like “8”
- DISPlay page command
  - DISPlay:PAGE <OPD | CHn | SRDn | MEND>
    - The command is used to switch the display page, in above, the parameter in < > is the abbreviation of page, which stands for:
  - OPD: OutPutDisp <Output display> page
    - CHn:CH1~CH3 page 'n' is the number 1,2, or 3, which matches to 3 channels
  - SRDn:SetRecallDisp<CH FILE >, 'n' is the number 1,2, or 3, which matches to 3 channels
  - MEND:MenuDisp <SYSTEM>
    - E.g. disp:page opd switch the page to <OUTPUT DISPLAY>.
  - DISPlay?
    - Inquire the current page, and return the parameter, like “opt”
- INSTrument channel selection command

- INSTRument:NSElect <1|2|3>
  - Select the channel to operate, which is the base of other commands
- INSTRument:NSElect ?
  - Inquire the current channel
- OUTPut output command
  - OUTPut <0|1|ON|OFF>
    - The command is used to control the on or off of output
  - OUTPut?
    - Used to inquire the output status of selected channel, return 0 or 1
- VOLTage voltage set command
  - VOLTage <set value |MIN|MAX|>
    - The command is used to set the voltage value of selected channel, the parameters in“< >”shows as:
  - Set value: the voltage value
  - MIN: Min. value 0
  - MAX; Max. voltage value, which can be set
  - VOLTage?
    - Inquire the voltage set value of selected channel
  - VOLTage:PROTection <set value |MIN|MAX|>
    - The command is used to set over voltage protective value, and Min. value is 0, and the Max. value is determined by the model.
  - VOLTage:PROTection ?
    - Inquire the over voltage protective value of the selected channel.
  - VOLTage:MAXvolt <set value |MIN|MAX >
    - The command is used to set the Max. value of set voltage, then the set value can't over it.
  - VOLTage:MAXvolt ?
    - Inquire the Max. voltage of the selected channel
- CURRent current set command
  - CURRent <set value |MIN|MAX >
    - The command is used to set the current value of selected channel, the parameters in“< >”shows as:
  - Set value: current value
  - MIN: Min. value 0
  - MAX: Max. value, which is determined by model
  - CURRent?
    - Inquire the current set value of selected channel

- TIMer timer set command
  - TIMer <0|1|ON|OFF>
    - The command is used to control the switch of timer
  - TIMer?
    - Inquire the status of timer, return 0 or 1
  - TIMer: DATA<0 ~ 99999.9>
    - The command is used to set the time of selected channel, Min. value is 0 and Max. value is 99999.9s
  - TIMer: DATA?
    - Inquire the time value of selected channel
- APPLy Complex control command
  - APPLy: VOLTage <voltage value>,< voltage value >,< voltage value >
    - The command is used to set the voltage value of 3 channels
  - APPLy: VOLTage?
    - Inquire the voltage value of 3 channels
  - APPLy: MAXvolt <voltage value>,< voltage value >,< voltage value >
    - The command is used to set the Max. voltage value of 3 channels
  - APPLy: MAXvolt?
    - Inquire the Max. voltage value of 3 channels
  - APPLy:PROTection <voltage value>,< voltage value >,< voltage value >
    - The command is used to set the over protection voltage value of 3 channels
  - APPLy: PROTection?
    - Inquire the over protection voltage value of 3 channels
  - APPLy: CURRent <current value>,< current value >,< current value >
    - The command is used to set the current value of 3 channels
  - APPLy: CURRENT?
    - Inquire the current value of 3 channels
  - APPLy: TIMer:DATA <timer value>,<timer value >,< timer value >
    - The command is used to set the time value of 3 channels
  - APPLy: TIMer:DATA?
    - Inquire the timer value of 3 channels
  - APPL:OUT <0|1|ON|OFF>,<0|1|ON|OFF>,<0|1|ON|OFF>
    - The command is used to control the output On or off of 3 channels
  - APPL:OUT ?
    - Inquire the output status of 3 channels



- MEASure measure command
  - MEASure:VOLTage?
    - The command is used to inquire the measured voltage value
  - MEASure:CURRent?
    - The command is used to inquire the measured current value
  - MEASure:TIMer?
    - The command is used to inquire the current timer value
  - MEASure: POWER?
    - The command is used to inquire the measured power value
  - MEASure:VOLTage:ALL ?
    - The command is used to inquire the voltage value of all channels
  - MEASure:CURRent:ALL ?
    - The command is used to inquire the current value of all channels
  - MEASure:TIMer:ALL ?
    - The command is used to inquire the timer value of all channels
  - MEASure: POWER:ALL ?
    - The command is used to inquire the measured power value of all channels
- FUNction recall command
  - FUNction SAV
    - The command is used to save the set voltage, current, Max. voltage and over protection voltage to the file list
  - FUNction:RECall <1~40>
    - The command is used to load any group in CH FILE
  - FUNction:RECall? <1~40>
    - The command is used to inquire any group in CH FILE
  - FUNction:DELeTe <1~40|ALL>
    - The command is used to delete one group or clear all list
- MENu menu function command
  - MENu:LANG <0|1|EN|CN>
    - The command is used to select the language, 0 and CN is Chinese, 1 and EN is English
  - MENu:LANG?
    - The command is used to inquire the current language,, return cn or en.
  - MENu:VOICe <0|1|ON|OFF>
    - The command is used to turn on or off the beeper
  - MENu:VOICe?

- The command is used to inquire the status of beeper
- MENU:PMEM <DEFault|USER>
  - The command is used to set memory status, default and user
- MENU:PMEM ?
  - Inquire the memory status
- MENU:RWAIT <0s|5s|10s|20s|30s|60s>
  - The command is used to set the retest wait time
- MENU:RWAIT?
  - The command is used to inquire the wait time
- MENU:COMBine <0~7>
  - The command is used to set the combine way, 0~7 means different combine ways, more details in Combine section
- MENU:COMBine ?
  - The command is used to inquire the combine way
- Date clock command
  - DATE:<YEAR|MONTH|DATE|HOUR|MIN|SEC> <set value>
    - The command is used to set RTC, the parameter in first “< >”is year, month, day, hour, minute, second, and in second “< >”is the detailed value
  - DATE?
    - The command is used to inquire the current date

## **Limited One-Year Warranty**

Global Specialties (a brand of Cal Test Electronics) warrants these products to be free from defective material or workmanship for a period of 1 year from the date of original purchase. Under this warranty, Global Specialties is limited to repairing the defective device when returned to the factory, shipping charges prepaid, within the warranty period.

Units returned to Global Specialties that have been subject to abuse, misuse, damage, or accident, or have been connected, installed, or adjusted contrary to the instructions furnished by Global Specialties, or that have been repaired by unauthorized persons, will not be covered by this warranty.

Global Specialties reserves the right to discontinue models, change specifications, price, or design of this device at any time without notice and without incurring any obligation whatsoever.

The purchaser agrees to assume all liabilities for any damages and/or bodily injury which may result from the use or misuse of this device by the purchaser, his employees, or agents.

This warranty is in lieu of all other representations or warranties expressed or implied and no agent or representative of Global Specialties is authorized to assume any other obligation in connection with the sale and purchase of this device.